

While not strictly a compendium on baluns, W2FMI does review the amateur literature, both fact and fanciful, on the subject. He also presents the results of his experiments plus workable designs that we can build.

More On The 1:1 Balun

BY JERRY SEVICK*, W2FMI

My most recent CQ article entitled "More On The 4:1 Balun"¹ presented some new 4:1 designs as well as an evaluation of the designs which have appeared in our amateur radio literature over the years. If you read the article, you saw that I was very critical of the information made available to amateurs. In fact, it was shown that a very poor design was converted into a "peerless" design by making three simple changes. The number of bifilar turns was changed from 10 to 14, the cross-sectional area of the toroid was doubled by stacking two together, and the wires were covered with Teflon tubing, resulting in the optimum characteristic impedance of the coiled transmission line. These changes made very significant improvements in both the low- and high-frequency responses of the 4:1 balun.

This article can be said to be a complement to the 4:1 balun article. In this case it treats the much more popular 1:1 balun. It begins with my view on when to use a balun. Even though much of what has been written here is taken from my Summer 1992 article in *Communications Quarterly*,² it is presented again here, since some of you don't subscribe to that journal. As before, highlights are also given on what has been available in the professional and amateur radio literature on the understanding and design of the 1:1 balun.

This information is then followed by some of my latest designs. Of special interest might be the one I call the "economy" model. Economy, in this case, refers to economy in labor. I hope some of these baluns are constructed and compared with the "expensive" (in labor) models also described in this article.

The article finally closes with a short summary of the significant points brought forth in this essay. As will be seen (again), the information available to radio amateurs has been sorely lacking over the past 25 years (at least)!

When To Use A Balun

Baluns have taken on a more significant role in the past few decades with the advent of solid-state transceivers and Class B linear amplifiers, which have unbalanced outputs—that is, the voltage on the center conductor of their output chassis connectors varies (plus and minus) with respect to ground. In many cases coaxial cables are used as the transmission lines from these unbalanced outputs

to antennas such as dipoles, inverted Vees, and Yagi beams which favor a balanced feed. In essence, they prefer a source of power the terminals of which are balanced (voltages being equal and opposite) with respect to actual ground or to the virtual ground which bisects the center of the antenna. The question frequently asked is whether a 1:1 balun is really needed.

To illustrate the problem involved and to give a basis for my suggestions, I refer you to fig. 1. Here we have, at the feed point of the dipole, two equal and opposite transmission-line currents which have two components each— I_1 and I_2 . Also shown is the spacing (s) between the center conductor and the outside braid. Theoretically, a balanced antenna with a balanced feed would have a ground (zero potential) plane bisecting this spacing. However, since a coax-feed is unbalanced and the outer braid is also connected to ground at some point, an imbalance exists at the feed point, giving rise to two antenna modes. One is with I_1 giving a dipole mode, and the other is with I_2 giving an inverted-L mode.

If the spacing (s) is increased, the imbalance at the feed point becomes greater, giving rise to more current on the outer braid and a larger unbalance of currents on the antenna's arms. Several steps can be taken to eliminate or minimize the undesirable inverted-L mode (eliminate or minimize I_2). The obvious one is to use a well-designed balun, which not only provides a balanced feed, but also minimizes (by its choking reactance) I_2 if the coaxial cable does not lie in the ground plane which bisects the center of the dipole. The other step is to ground the coaxial cable at a quarter-wave (or odd-multiple thereof) from the feed point. This discourages the inverted-L mode, since it wants to see a high impedance at these lengths instead of the low impedance of a ground connection.

Experiments with baluns were conducted on a 20 meter half-wave dipole at a height of 0.17 wavelength, which gave a resonant impedance of 50 ohms. VSWR curves were compared under various conditions. When the coaxial cable was in the ground plane of the antenna (that is, perpendicular to the axis of the antenna), the VSWR curves were identical with or without a well-designed balun no matter where the outer braid was grounded. Only when the coaxial cable was out of the ground plane was a significant difference noted. When the cable dropped down at a 45 degree angle

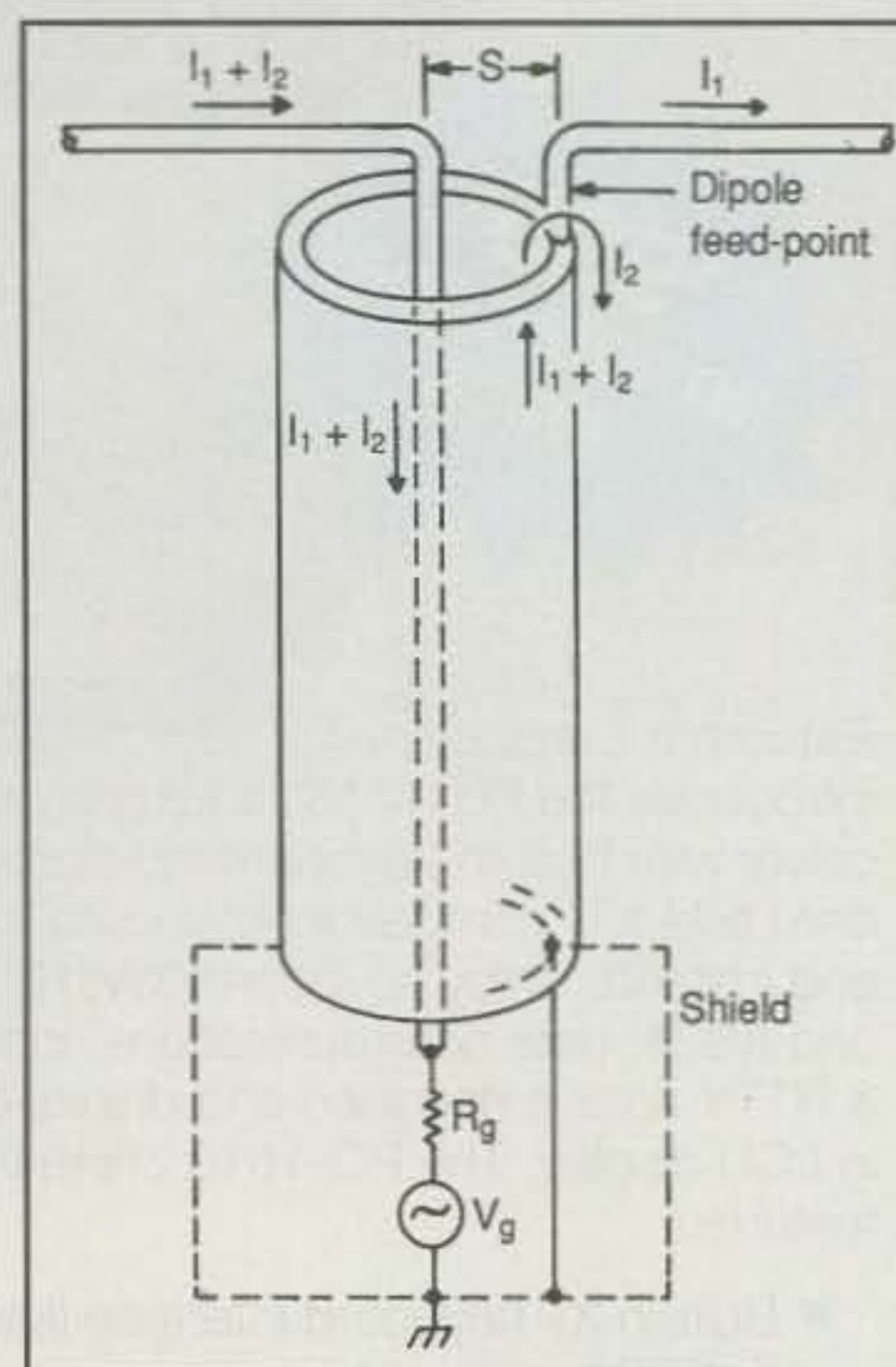

Fig. 1—Illustration of the various currents at the feed point of a dipole. I_1 is the dipole current and I_2 is the inverted-L (imbalance) current.

under the dipole, a large change in the VSWR took place. This meant the inverted-L mode was appreciable.

It should also be pointed out that the direction of I_2 , the imbalance current, can depend upon the side on which the coaxial cable is out of the ground plane of the dipole. For example, if it comes down under the right side in fig. 1 (that is, the angle between the horizontal arm and the coax is less than 90 degrees on the right side and more than 90 degrees on the left side), then the direction of I_2 can be reversed by the imbalance in the induced currents on the outside of the braid. By the same token, by having the coaxial cable come down on the other side, the value of I_2 is only increased in magnitude.

Feeding a Yagi beam without a well-designed 1:1 balun, however, is a different matter. Since most Yagi designs use shunt-feeding (usually by hair-pin matching networks) in order to raise the input impedance close to 50 ohms, the effective spacing (s) is greatly increased. Furthermore, the center of the driven element is actually grounded. Thus, connect-

*32 Granville Way, Basking Ridge, NJ 07920

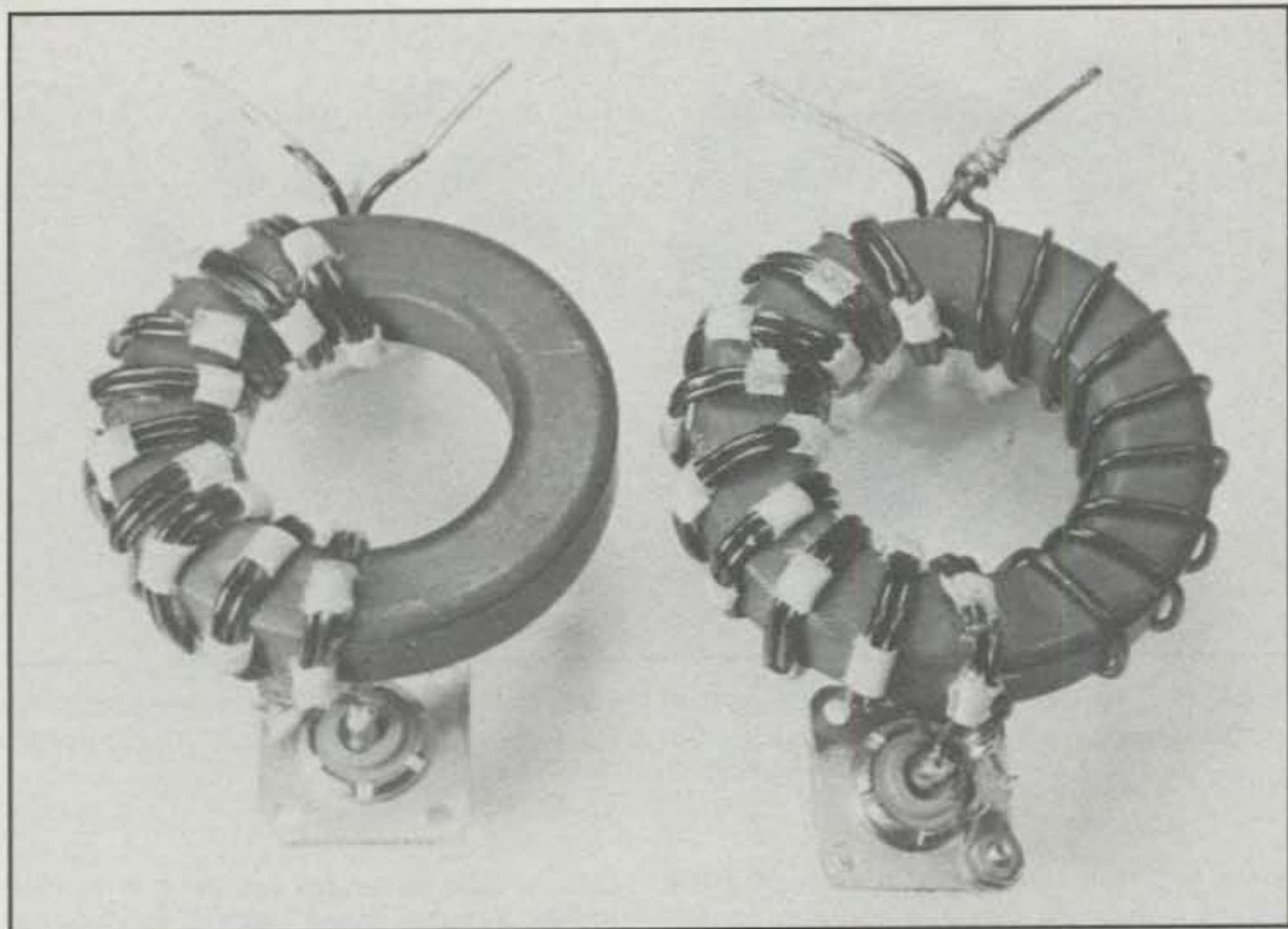

Photo A—The two basic forms of the 1:1 balun which first appeared in the professional literature. The two-conductor Guanella balun is on the left and the three-conductor Ruthroff balun is on the right.

ing the outer braid (which is grounded at some point) to one of the input terminals creates a large imbalance and hence a real need for a balun. An interesting solution, which would eliminate the matching network, is to use a step-down balun designed to match 50 ohm cable directly to the lower balanced-impedance of the driven element.³

In summary, if one concurs with the theoretical model of fig. 1, my experiments performed on 20 meters, and the reports from radio amateurs using dipoles and inverted Vees without baluns, then it appears that 1:1 baluns are really needed for (a) Yagi beam antennas where severe pattern distortion can take place without one and (b) dipoles and inverted Vees that have the coaxial cable feed lines out of the ground plane that bisects the antennas or that are unbalanced by their proximity to man-made or natural structures. In general, the need for a balun is not so critical with dipoles and inverted Vees (especially on 40, 80, and 160 meters) because the diameter of the coaxial cable connector at the feed point is much smaller than the wavelength.

If my model—which assumes that a part of the problem when feeding balanced antennas with coaxial cable is related to the size of the spacing (s), shown in fig. 1—is correct, then the possibility exists for using ununs for matching into balanced antennas with impedances other than 50 ohms and with small values of s . For example, half-wave dipoles at a height of about a half-wave, quads and center-fed $3/2$ -wave dipoles which all have impedances close to 100 ohms, could very well be matched to 50 ohm cable by a 2:1 unun.⁴ As was shown, they are considerably easier to construct than 2:1 baluns.⁵ Furthermore, Genaille⁶ has recently shown considerable success in using ununs in this kind of application.

In closing this section I would like to comment on an article published by Eggers, WA9NEW,⁷ concerning the use of a balun with

a half-wave dipole. While at North Carolina State University, he conducted an experimental investigation of pattern distortion without a balun at 1.6 GHz in an RF anechoic chamber (which simulates "free space"). Briefly, his results showed that with a balun (a bazooka type), the radiation pattern compared very favorably with the classic "figure-eight" pattern. Without the balun, the radiation pattern was severely distorted.

Even though the author expressed difficulty in obtaining accurate measurements at this very high frequency, I have a question regarding the validity of performing the experiment

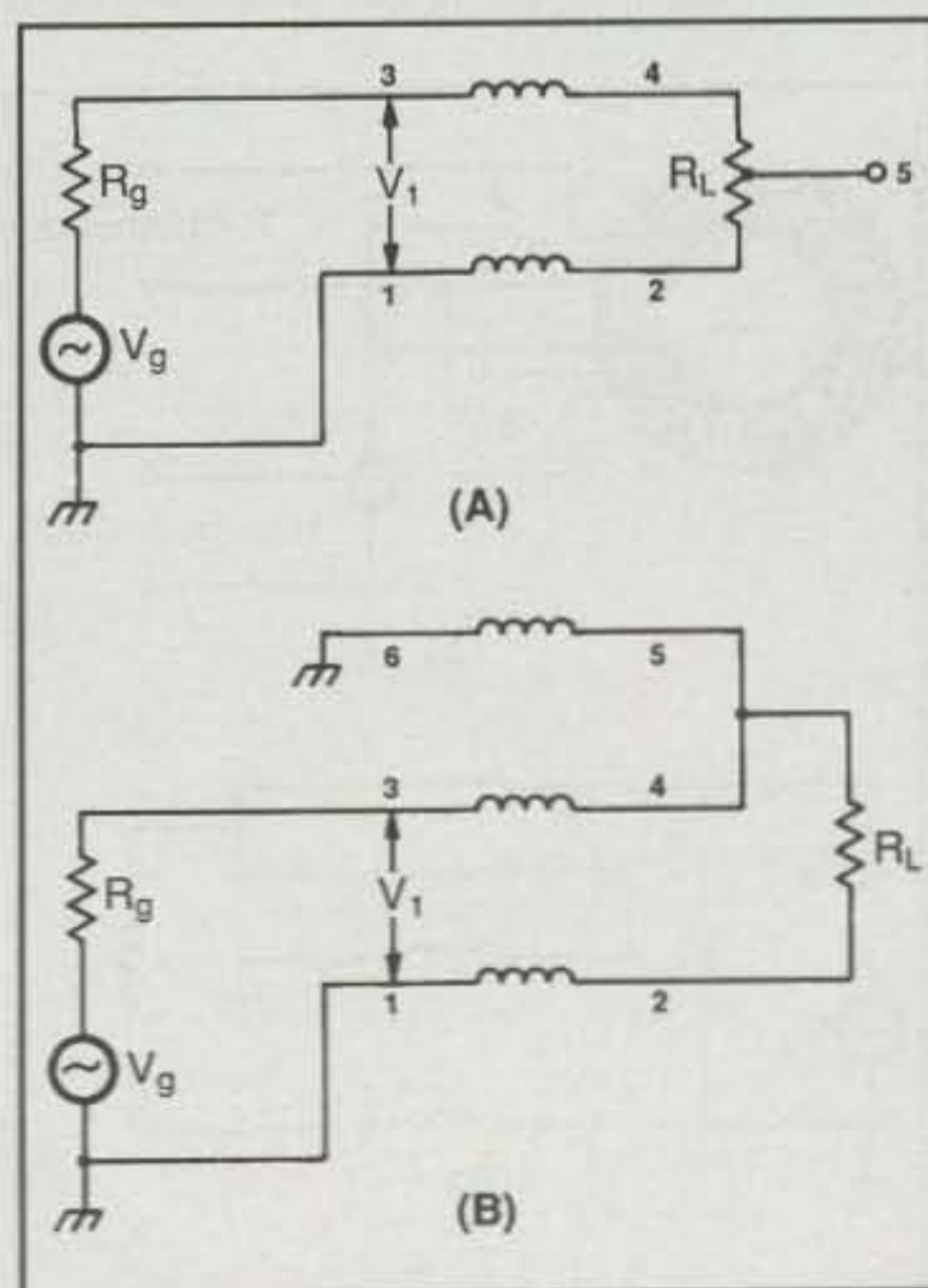

Fig. 2—Two versions of the 1:1 balun: (A) The Guanella balun and the basic building block; (B) The Ruthroff balun as originally drawn.

Introducing the... HIGH SIERRA HF Mobile Antenna

Based on W6AAQ's famous DK3 ("screwdriver") antenna...with some improvements.



"decoupler"

High performance, proven design. Heavy duty construction. All machined parts—stainless steel hardware!

Continuous coverage from 3.5MHz to 30MHz. All without setting foot outside your car, motorhome, or RV!

Exclusive "decoupler" eliminates need for contact fingers...very reliable!

Built-in matching device. Low SWR over entire range. No antenna tuner required!

Rainshield & base mount hardware kit included!

\$289 (plus S & H)

High Sierra Antennas
P.O. Box 2389
Nevada City, CA
95959, USA

Tel: (916) 273-3415

Fax: (916) 273-7561

Write for brochure

ICOM

IC-728 HF Xcvr./Gen. Cov. Rcvr.	\$899.00
IC-735 HF Xcvr./Gen. Cov. Rcvr.	1054.00
IC-737A HF Xcvr./Gen. Cov. Rcvr.	1469.00
PS-55 AC Power Supply	226.00
AT-150 HF Automatic Antenna Tuner	439.00
SM-8 Desk Microphone	111.00
SP-7 Base Station External Speaker	68.00
SP-10 Mobile External Speaker	43.00
SP-20 Base Station Ext. Spkr. W/Audio Filters	162.00
IC-R1 Communications Receiver	469.00
IC-R7000 Communications Receiver	1249.00
IC-R7100 Communications Receiver	1319.00
IC-228H 2-Meter, FM, 45 Watt Xcvr.	369.00
IC-229H 2-Meter, FM, 50 Watt Xcvr.	389.00
IC-3230H 2-Mtr./440-MHz., FM, 45W/35W	649.00
IC-2GAT 2-Mtr., FM, Handheld With T-T	294.00
IC-4GAT 440-MHz., FM, Handheld With T-T	294.00
IC-2GXAT 2-Meter, FM, Mini Handheld W/T-T	294.00
IC-2SRA 2-Mtr./50-905-MHz., FM, Mini H-H/T-T	499.00
IC-W2A 2-Mtr./440-MHz., FM, Mini H-H W/T-T	474.00
BP-4 Battery Case	20.00
BP-5 10.8 VDC, 425 mA., Ni-Cad Batt. Pack	73.00
BP-7 13.2 VDC, 425 mA., Ni-Cad Batt. Pack	87.00
BP-8 8.4 VDC, 800 mA., Ni-Cad Batt. Pack	87.00
CM-96 8.4 VDC, 1200 mA., Ni-Cad Batt. Pack	99.00
BP-83 7.2 VDC, 600 mA., Ni-Cad Batt. Pack	65.00
BP-84 7.2 VDC, 1000 mA., Ni-Cad Batt. Pack	87.00
BP-90 Battery Case	20.00
BP-130A Battery Case	21.00
BP-157A 7.2 VDC, 900 mA., Ni-Cad Batt. Pack	54.00
BP-160 7.2 VDC, 700 mA., Ni-Cad Batt. Pack	43.00
BC-35U Desktop Charger; BP-2, 5, 7, 8, 96	95.00
BC-72A Desktop Chg.; BP-81, 82, 83, 84, 85, Int.	104.00
BC-79A/AD-28 Dsktp. Chg.; BP-132A, 157A, 160	131.00
CP-11 Cigarette Lighter Cable W/Noise Filter	29.00
CP-12 Cigarette Lighter Cable W/Noise Filter	21.00
CP-13 Cigarette Lighter Cable W/Noise Filter	22.00
HM-46 Speaker/Microphone	40.00
HM-54 Speaker/Microphone	55.00
HM-65 Speaker/Microphone For IC-2SRA/W2A	42.00
HM-70 Speaker/Microphone For IC-2SRA/W2A	42.00
HS-51 Headset, PTT & VOX	67.00
HS-60 Headset, PTT & VOX, For IC-2SRA/W2A	76.00

BENCHER

BY-1 Iambic Paddles, Black Base	\$64.95
BY-2 Iambic Paddles, Chrome Base	79.95
ZA-1A 1:1 Balun, 3.5 To 30-MHz.	34.95

CUSHCRAFT

R5 14, 18, 21, 24, 28-MHz. Vertical	\$267.00
R7 7, 10, 14, 18, 21, 24, 28-MHz. Vertical	357.00
ARX-2B 2-Meter, Ringo Ranger II Vertical	49.00
ARX-220B 220-MHz., Ringo Ranger II Vertical	49.00
ARX-450B 450-MHz., Ringo Ranger II Vertical	49.00
AR-270 2-Meter/440-MHz., Ringo Vertical	61.00
AR-270B 2-Meter/440-MHz., Ringo Vertical	88.00
ARX-270U 2-Mtr./440-MHz., Fiber. Ringo Vert.	188.00
A50-5S 50 To 54-MHz., 5-Element Beam	119.00
124WB 144 To 148-MHz., 4-Element Beam	49.00
A148-10S 144 To 148-MHz., 10-Element Beam	56.00
13B2 144 To 148-MHz., 13-Element Beam	95.00
224WB 222 To 225-MHz., 4-Element Beam	47.00
225WB 222 To 225-MHz., 15-Element Beam	98.00
A449-6S 440 To 450-MHz., 6-Element Beam	40.00
A449-11S 440 To 450-MHz., 11-Element Beam	57.00

ASTRON

RS-7A 13.8 VDC, 7 Amp Int., 5 Amp Cont.	\$49.50
RS-12A 13.8 VDC, 12 Amp Int., 9 Amp Cont.	71.50
RS-20A 13.8 VDC, 20 Amp Int., 16 Amp Cont.	88.50
RS-35A 13.8 VDC, 35 Amp Int., 25 Amp Cont.	141.50
RS-12M Same As RS-12A, With Meters	82.50
RS-20M Same As RS-20A, With Meters	108.50
RS-35M Same As RS-35A, With Meters	159.50
VS-35M Same As RS-35M, Adj. Volt./Curr.	171.50

UPS/Insurance Charges Are Additional
MC And VISA Orders Are Accepted
Prices Subject To Change Without Notice

LaRue Electronics

1112 GRANDVIEW STREET
SCRANTON, PENNSYLVANIA 18509
PHONE (717) 343-2124

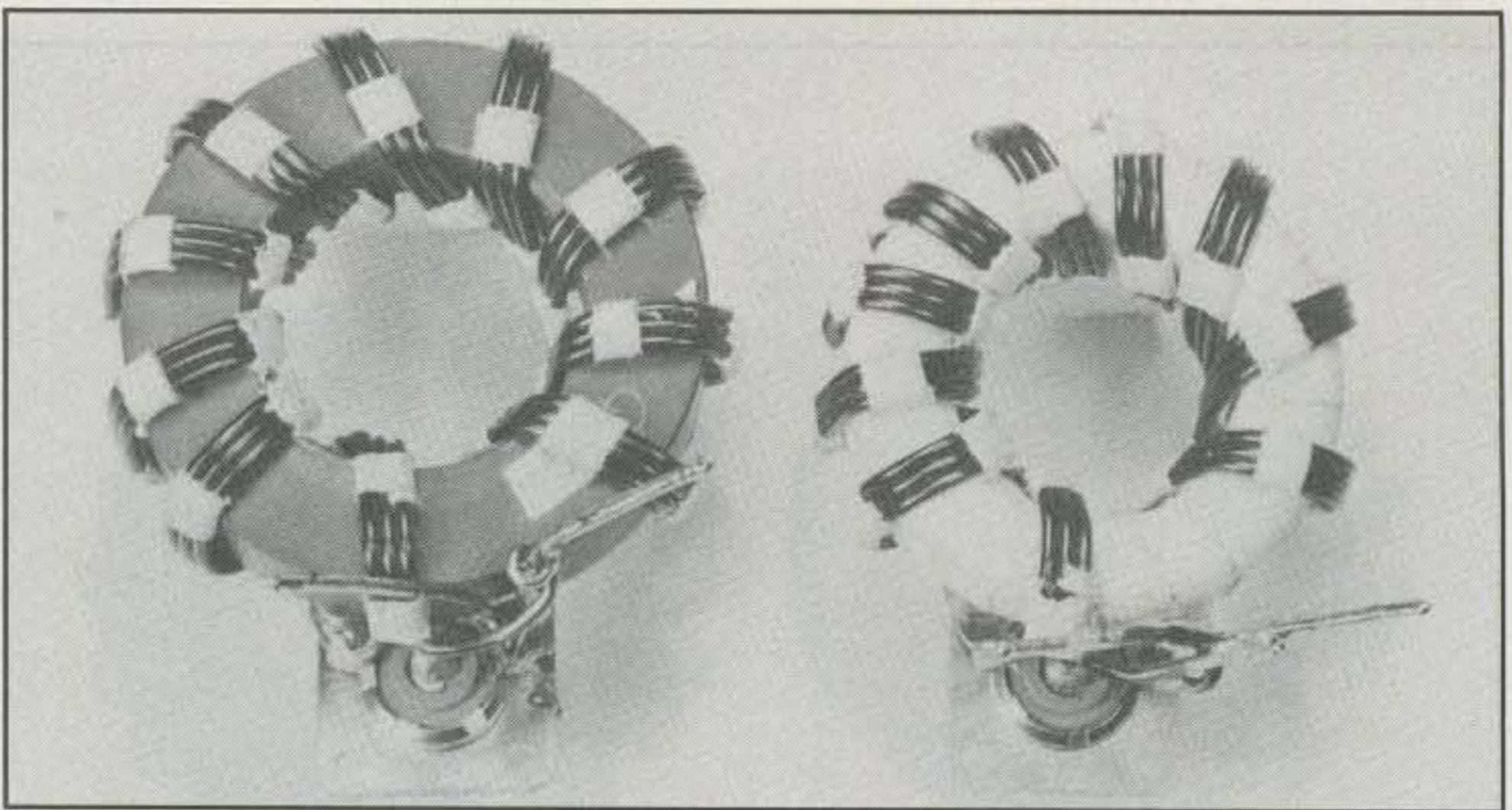

Photo B— Two versions of Turrin's design: on the left, the 1:1 balun that has appeared in the amateur radio literature; on the right, a 1:1 balun that has been readily available in kit form from Amidon Associates, Inc.

in the first place. From the photograph in the article it appears that conventional coaxial cable and connectors were used in the experiment. If we assume an effective diameter of 0.375 inches for these components, then scaling up to 3.5 MHz (457.14 fold) results in a coaxial cable with a diameter of 14.28 feet! I am quite sure that the large spacing (s) of 7.14 feet would bring about a noticeable imbalance, resulting in appreciable pattern distortion even at 3.5 MHz.

Highlights of Significant Articles on 1:1 Baluns

Although there have been many articles published in the professional and amateur literature, I have selected a few that I thought had the most impact on 1:1 baluns for amateur radio use. As you will see, even though I consider some of the amateur articles significant, their impact upon the use and understanding

of these devices has not always been positive. In fact, in some cases just the opposite has been true.

In The Professional Literature

As I noted in a recent CQ article,⁵ there are actually only two significant articles in the professional literature that provide the fundamental principles upon which the theory and design of this class of transformers are based. It can be said that succeeding investigators only really extended the works of the authors of these two articles.

The first presentation on broadband matching transformers using transmission lines was given by Guanella in 1944.⁸ He coiled transmission lines forming a choke such that only transmission-line currents were allowed to flow no matter where a ground was connected to the load. His single, coiled transmission line resulted in a 1:1 balun. It is shown on the left in fig. 2(A). Prior to this RF baluns were achieved by the use of quarter- and half-wave transmission lines, and as a result, had narrow bandwidths. Guanella then demonstrated broadband baluns with impedance transformations of 1:n² where n is the number of transmission lines he connected in a series-parallel arrangement.

Several important points should be made regarding Guanella's 1:1 balun shown in fig. 2(A). With sufficient choking reactance so that the output is isolated from the input and only transmission-line currents flow, by grounding terminal 5 (actually or virtually like the center of a dipole), terminal 4 becomes +V₁/2 and terminal 2 becomes -V₁/2, resulting in a balanced output. This type of balun has lately been called a "current" or "choke" balun. A significant feature of this model is that a potential gradient of -V₁/2 exists along the length of the transmission line. This gradient, which exists on both conductors, accounts for practically all of the loss in these transformers, since the loss-mechanism is voltage-dependent (a dielectric-type loss). All transmission-line transformers have some sort of voltage gradient along their transmission lines and are thus subject to the same type of losses. Furthermore, the theory and loss-mechanism are the same whether the transmission lines are

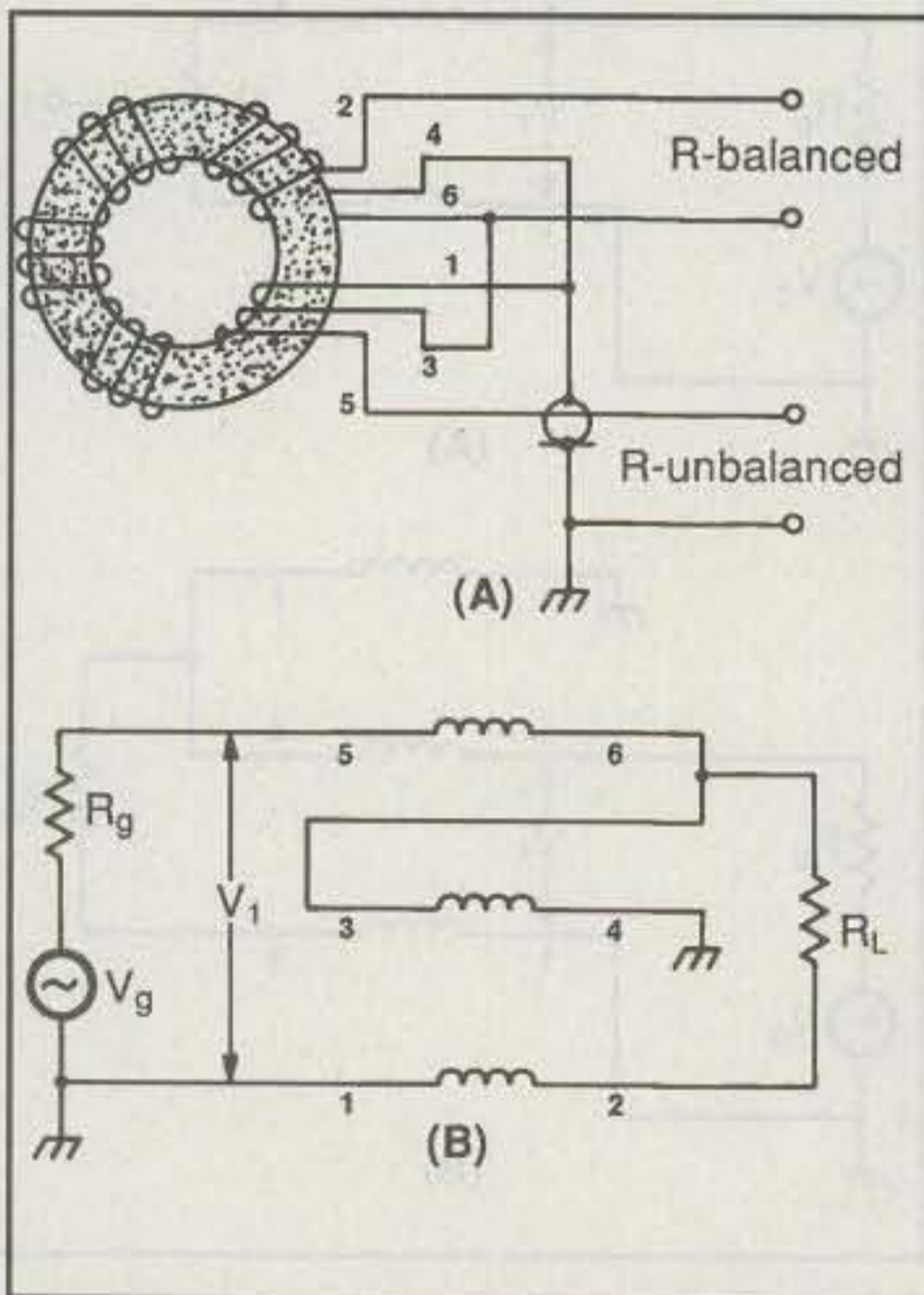

Fig. 3— (A) A pictorial of Turrin's 1:1 balun, and (B) a schematic of his balun.

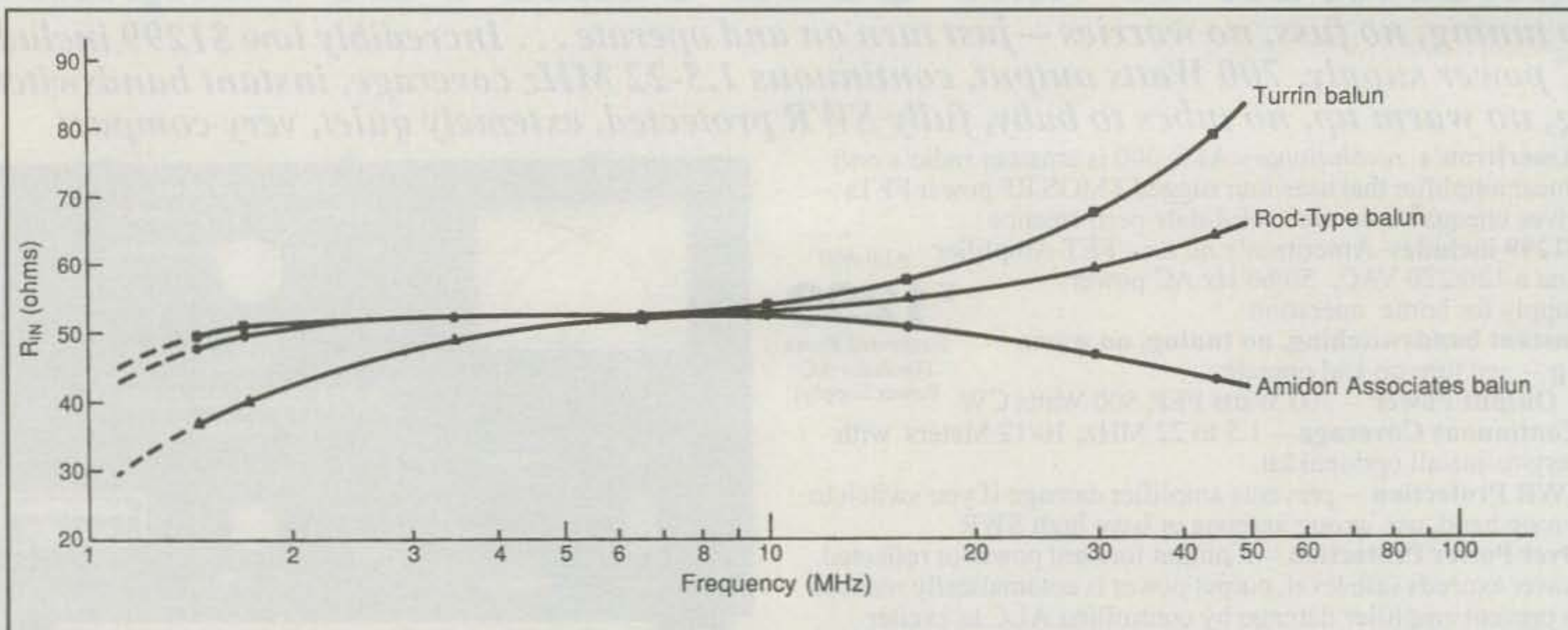

Fig. 4—The input impedance versus frequency, when terminated with 50 ohms, for the Turrin, rod-type, and Amidon 1:1 baluns.

coax or twin-lead or coiled around cores or threaded through ferrite beads. Additionally, it was shown³ that higher-impedance baluns or baluns subjected to higher VSWRs have more loss because the voltage gradients are also larger.

The second and other significant article on broadband transmission-line transformers was by Ruthroff in 1959.⁹ His 1:1 balun, which is shown originally drawn in fig. 2(B), used an extra winding to complete (as he said) the path for the magnetizing current. Even though his schematic drawing appeared to look like a trifilar winding, his pictorial in the article clearly showed that the third winding (5–6) was on a separate part of the toroid. With an equal number of turns, it forms a voltage divider with winding (3–4) placing terminal 4 at $+V_1/2$ and terminal 2 at $-V_1/2$. Ruthroff also presented in his classic paper his forms of the 4:1 balun (which are also different from Guanella's), a 4:1 unun, and various hybrids. Photo A shows the two basic forms of the 1:1 balun which first appeared in the professional literature. The two-conductor Guanella 1:1 balun is on the left and the three-conductor Ruthroff balun is on the right. As was mentioned before, the Guanella balun recently has been called a "current" or "choke" balun.

Before going on to the significant articles in the amateur radio literature, some mention should be made of the differences between the two basic forms shown in photo A. Guanella's 1:1 balun came to be known as the *basic building block* for this whole class of broadband transformers. This term was coined by Ruthroff as he showed its 1:1 balun capability when the load was grounded at its center (terminal 5) and as a phase-inverter when the load was grounded at the top (terminal 4). By connecting terminal 2 to terminal 3 and connecting the bottom of the load to ground, Ruthroff then demonstrated his very popular 4:1 unun. I called this type of arrangement the "boot-strap" connection. Furthermore, by grounding terminal 2, there is no potential drop along the transmission line and therefore no need for magnetic cores or beads. This arrangement, which turns out to

be an important function for extending the high-frequency performance of this class of transformers, I call the "phase-delay" connection.

Thus, with the flexibility shown by Guanella's basic building block, a 1:1 balun is now realized which not only presents a balanced power source to a balanced antenna system, but can also prevent an imbalance current (an inverted-L antenna current) by its choking reactance when the load is unbalanced or mismatched or when the feedline is not perpendicular to the axis of the antenna.

Interestingly enough, except at the very low end of the frequency response of the Ruthroff 1:1 balun where autotransformer action can take place, his balun takes on the characteristics of the Guanella balun. The reactance of the third winding becomes great enough to make it literally transparent. This is not the nature of the trifilar-wound (voltage) balun, which is sensitive to unbalanced and mismatched loads over its entire passband, since it is actually two tightly coupled transmission lines. This distinction was not recognized by most of those who published in the amateur radio literature.

In The Amateur Radio Literature

R. Turrin, W2IMU—1964. The first presentation in the amateur radio literature on 1:1

baluns using ferrite cores was by Turrin in 1964.¹⁰ Turrin, who was a colleague of Ruthroff at Bell Labs, took his small-signal design (which used No. 37 or 38 wire on toroids with ODs of 0.25 inch or less) and adapted it to high-power use. This was done by using thicker wire, larger cores, and (very important for high efficiency³) low-permeability ferrite. Ruthroff used lossy manganese-zinc ferrites with permeabilities of about 3000, since efficiency was not a major consideration.

Fig. 3 shows a pictorial and a schematic of Turrin's design. As you can see, the third wire (winding 3–4) is placed between the two current-carrying wires (windings 1–2 and 4–5). Photo B shows (on the left) his actual design using a ferrite core and a popular design (on the right) using a powdered-iron core that has been readily available in kit form. Both baluns use 10 trifilar turns of a single-coated wire such as Formex or Formvar on a toroid. Turrin's design uses a ferrite toroid with an OD of 2.4 inches and a permeability of 40. The kit balun uses a powder-iron toroid with a 2 inch OD and a permeability of only 10. Both baluns are specified to handle 1000 watts of power from 1.8 MHz to 30 MHz.

Fig. 4 shows the response curves for these two baluns when terminated with 50 ohm loads. Also shown is the response curve for a popular 1:1 rod-type balun which uses the

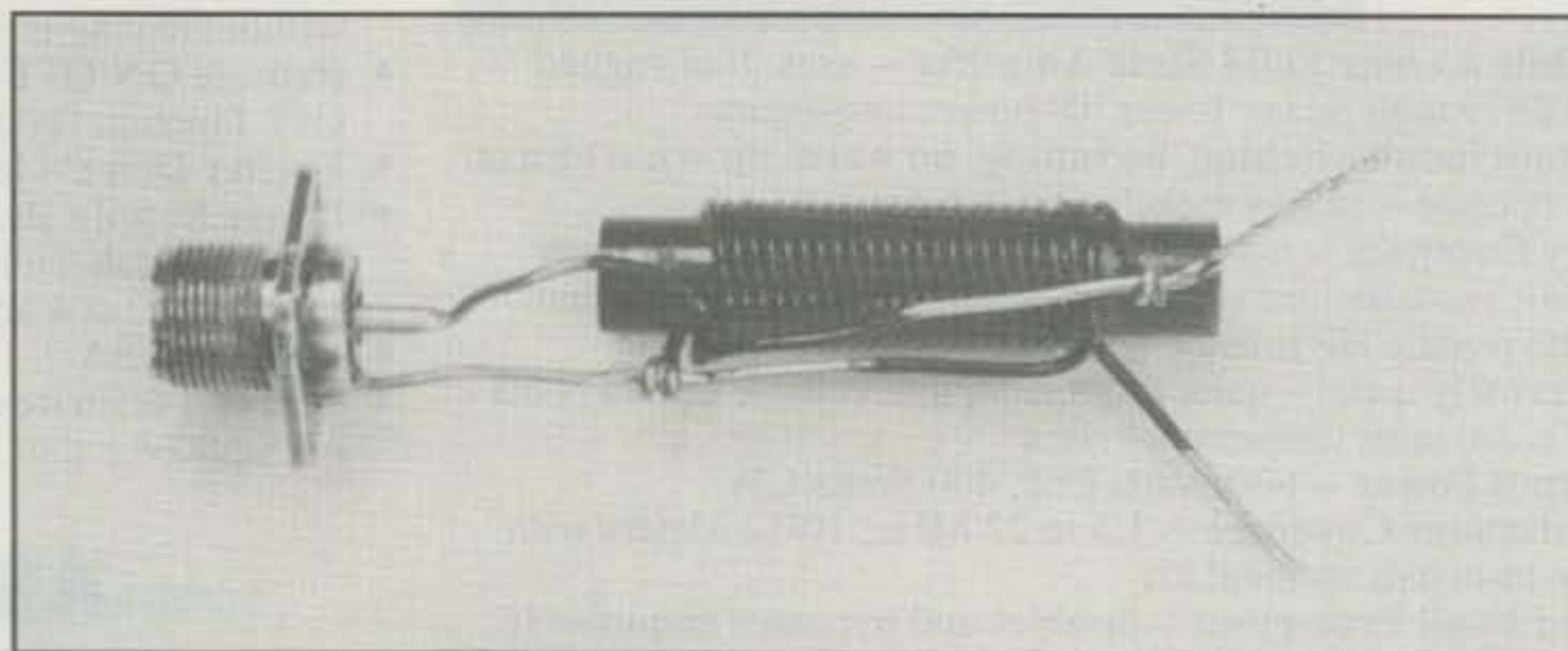

Photo C—A typical rod-type balun.

same "rod type" schematic and wire but on a ferrite rod. It has 8 trifilar turns tightly wound on a rod of 0.5 inch diameter, 2.5 inches long, and with a permeability of 125. The rod-type balun is shown in photo C.

Several important features should be brought out regarding the results shown in fig. 4. They are:

1. All baluns had insufficient choking reactance and hence poor low-frequency responses. The powdered-iron version was especially poor. They all showed a drop in the input impedance and an inductive component at 2 MHz. This meant flux in the cores and an undesirable condition especially for ferrite, which is a non-linear material. Ferrite cores could not only suffer damage, but they also could generate spurious frequencies under these conditions. In fact, the same condition could occur at 4 MHz with a VSWR of 2:1! Therefore, I don't recommend any of these baluns for use on 160 or 80 meters.

2. The major problem at the low-frequency end is the role of the third winding (3-4) in fig. 3(B). It has been claimed¹¹ that the third winding improves the low-frequency response (over the two-conductor Guanella 1:1 balun) because it enables autotransformer action at the low end. But recent measurements by the author on two-conductor Guanella baluns and three-conductor Ruthroff (or Turrin) baluns with loads grounded at their centers show insignificant differences. This type of load approximates the actual condition when feeding a balanced antenna system. The negative feature of the third winding (3-4) is that at the low-frequency end there can be insufficient reactance to prevent harmful flux in the core because of a direct shunting path to ground. With the two-conductor 1:1 balun the only flux-causing current is that of the imbalance current (the inverted-L mode), which is usually far smaller.

3. Another important feature of the curves shown in fig. 4 is the effect of the characteristic impedances of the coiled transmission lines. For example, a bifilar winding (wires tight together) on a toroid exhibits a characteristic impedance of about 45 ohms. When wound on a rod with no space between adjacent bifilar turns, the characteristic impedance drops to about 25 ohms. With the third winding (3-4) between the other two as shown in fig. 3(B), the characteristic impedance is raised to about 70 ohms in the toroidal case and to about 47 ohms in the rod case. If the toroidal baluns were terminated in 70 ohms and the rod balun terminated in 47 ohms, the high-frequency responses would be practically flat to at least 30 MHz. The difference in high-frequency response between the two toroidal baluns (with 50 ohm loads) is due to the differences in the lengths of their transmission lines. The transmission line on the powdered-iron core is appreciably less, since the OD as well as the cross-sectional area is smaller.

4. The trifilar-wound form of the 1:1 balun also has an additional undesirable property. Its high-frequency response is sensitive to unbalanced and mismatched loads. This is because the third wire now forms two transmission lines which are now tightly coupled. It is unlike the Ruthroff version shown on the right in photo A. In his second article Turrin pointed out this important distinction.¹¹

J. Reiser, W1JR—1978. The next signifi-

DOUBLE DUTY!

New! Hy-Gain® V-42R 2M / 440 Vertical

Telex Hy-Gain antennas first raised the standards for amateur performance. Now our new dual-band antenna has doubled them. Independently tunable at 144 MHz and 440 MHz, the double duty V-42R is fed through one coax cable and delivers an impressive gain. The radiating collinear elements are two 5/8 wave (2M) and three 5/8 wave (440). The 2M band has a 2:1 VSWR bandwidth of 5 MHz minimum and a tuning range of 143 - 153 MHz; the 440 band has a 20 MHz minimum bandwidth, and a tuning range of 435 - 455 MHz. The V-42R handles 200 watts continuous power with 100 MPH wind survivability, and features stainless steel hardware and a Type "N" connector.

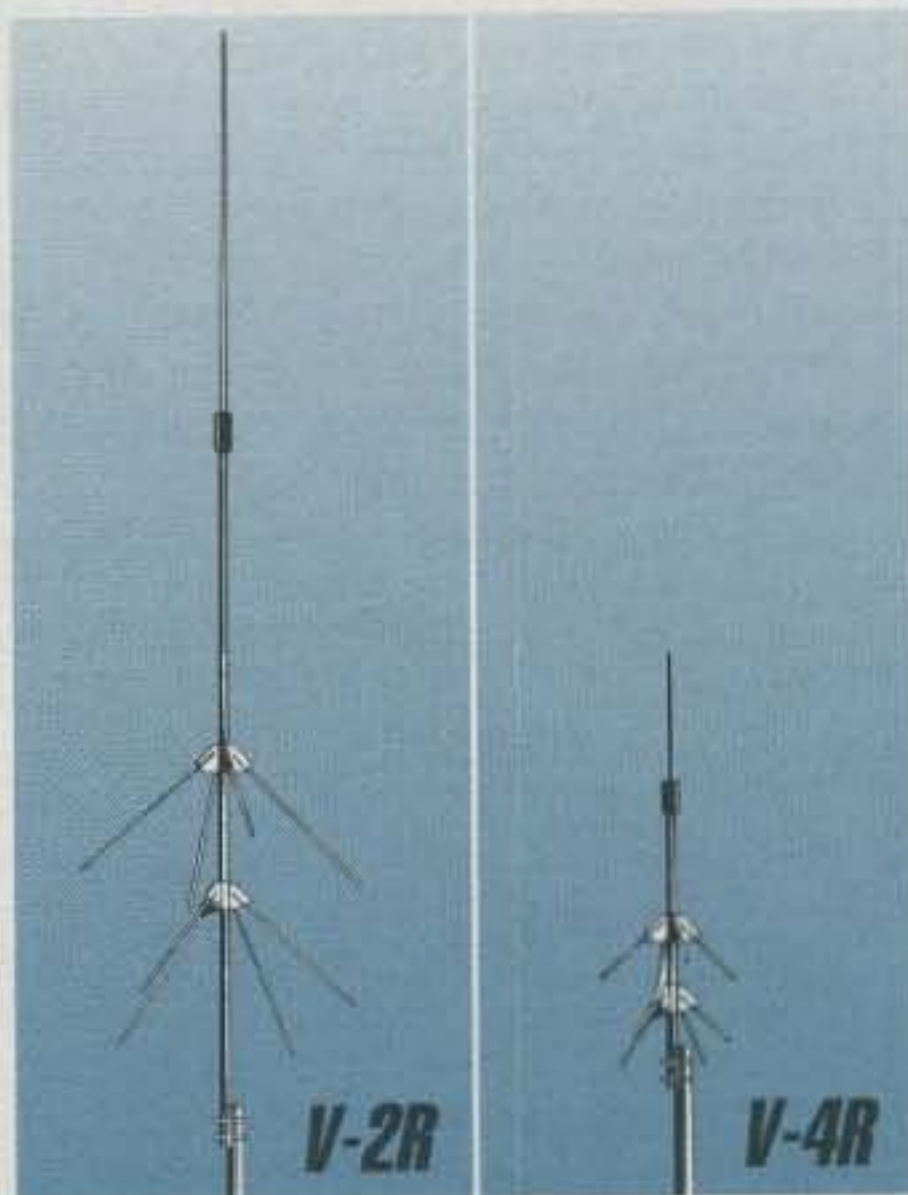

V-2R 2-meter 138-174 MHz

V-4R 440 400-475 MHz

Hy-Gain's extended double zepp antenna design is the hallmark of these popular V-series antennas. The radiating elements are two collinear 5/8 waves fed in phase. Two sets of 1/4 wave radials properly decouple the lower radiator from the mast. V-4R features a Type "N" connector.



hy-gain®
by Telex

TELEX COMMUNICATIONS INC.
9600 Aldrich Ave So., Minneapolis, MN 55420 U.S.A.
Telephone: 612-887-5530, 884-4051 • Facsimile: 612-884-0043

Introducing two of the best reasons to use packet radio

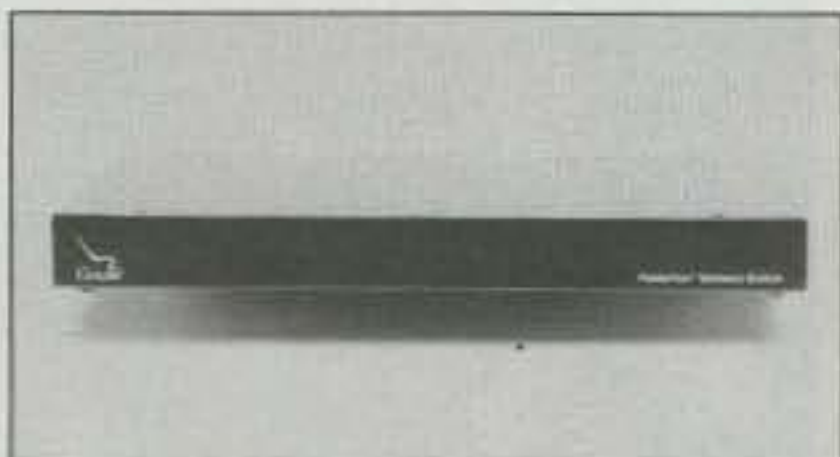

The PackeTen™ Network Switch

The PackeTen Network Switch is a stand-alone, five-port, low power CISC/RISC packet switch/router designed exclusively for use with AX.25, TCP/IP, and NET/ROM® wireless networks.

- Port speeds as high as 4Mbps possible with throughput into the mega-bit range
- Multiple RS-422, RS-232, and integral modems eliminate the need for complex node-stacks
- Integral conference bridge supports 100 channels with 40 users on each

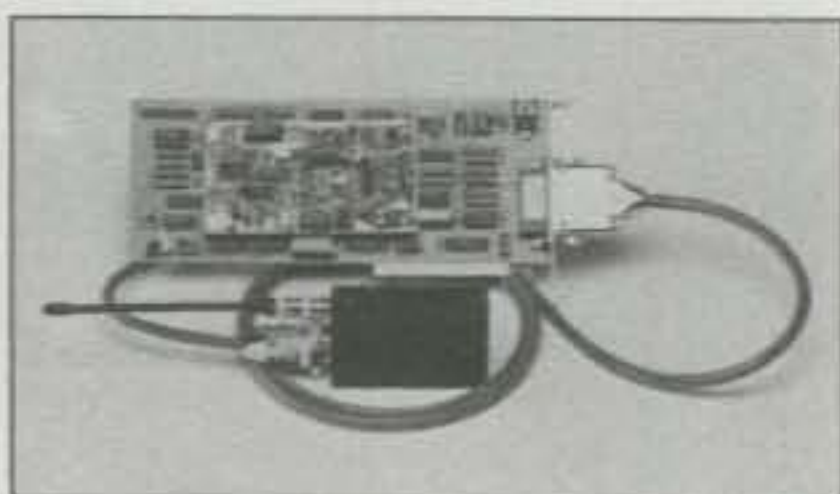

The PackeTwin™ System

The PackeTwin System is a complete wireless communications system for IBM® compatible PCs that provides ideal access to 9600 baud packet radio networks.

- Available with an on-board G3RUH 9600 baud modem and palm-size outboard 2W UHF radio (1200 baud available)
- Uses the PC's DMA channels to support data rates as high as 1Mbps—eliminating the asynchronous COM port bottleneck
- Second channel operation using RS-232 or RS-422 interface
- Includes free communications software

For information, contact your distributor or...



Gracilis

The new name in Packet Radio

Gracilis, Inc.
623 Palace Street
Aurora, IL 60506
Ph: (708) 801-8800/FAX: (708) 844-0183
Email: info@gracilis.com



All trademarks are property of their respective owners

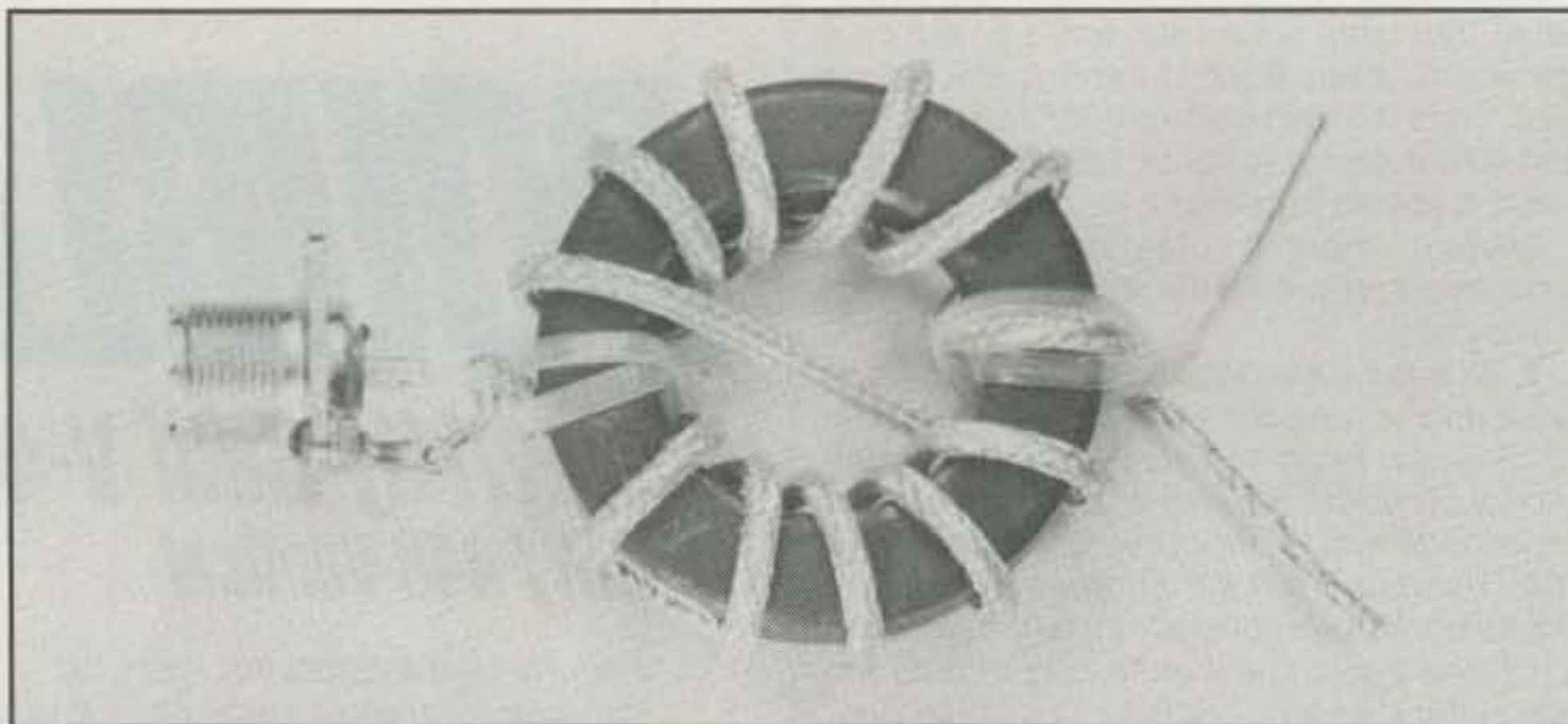

Photo D—A Reiser, W1JR, 1:1 balun.

cant article on 1:1 baluns was published by Reiser in 1978.¹² He proposed winding some of the smaller (but still high-powered) coaxial cables around a 2.4 inch OD ferrite toroid with a permeability of 125. The windings also included a cross-over which is shown in fig. 5 and photo D. In addition, he recommended various numbers of turns depending upon the low-frequency requirement. For example, 12 turns to cover 3.5 MHz, 10 turns for 7 MHz, 6 for 14 MHz, and 4 turns for 21 and 28 MHz. Since the characteristic impedance of the coaxial cable is the same as the coax feed line, the balun only introduces a foot or two of extra length to the feed line. This is true in the HF and VHF bands. The coaxial cables recommended in the article were RG-141/U, RG-142/U, and RG-303/U.

From the articles that followed in the amateur radio literature it became apparent that few recognized all of the important features of his balun, which were:

1. An efficient, low-loss ferrite was used.
2. The baluns had sufficient choking reactances for the various low-frequency requirements.
3. The characteristic impedance of the coiled transmission line was the same as that of the feed line, thus eliminating the extra transformer action of a length of transmission line with a different characteristic impedance.
4. The balun is a form of Guanella's two-conductor 1:1 balun which is not prone to core flux and hence saturation and the generation of spurious frequencies. It is also not susceptible to mismatched and unbalanced loads such as the Turrin and "voltage" baluns.

After constructing several of his baluns and comparing them with other Guanella designs, I found that the cross-over winding had virtually no effect up to 100 MHz (the limit of my equipment). My second comment is with regard to his VSWR comparison with a rod-type

balun when feeding a tri-band Yagi beam on 20 meters. His balun had a lower VSWR (practically 1:1) at the best match point. The rod-type balun had a best VSWR of about 1.3:1 but at a slightly higher frequency. He attributed the higher (and somewhat flatter) VSWR curve of the rod-type balun to its greater ohmic loss. Since the rod-type baluns I have investigated used the same low-loss ferrite that Reiser did, I suspect that the differences in the VSWR curves were mainly due to the mismatch loss introduced by the rod-type balun.

G. Badger, W6TC—1980. Badger published an in-depth, two-part series in 1980 on air-core baluns and ununs in *Ham Radio* magazine.^{13,14} I am sure it was instrumental in advancing the technology of this class of wide-band transformers. A recent article by Bill Orr, W6SAI, also shows that there are many other radio amateurs who see the advantages of air-core transformers.¹⁵

What are the claims for air-core baluns over their ferrite-core counterparts? The first and foremost claim is that they don't suffer the consequences of saturation, which leads to spurious frequencies, heating, and ultimate damage. Second, they are not subject to arcing from the windings to the core.

And what are the claims for the ferrite-core baluns over their air-core counterparts? Simply put, they have wider bandwidths and are more compact.

What especially came to my attention after reading Badger's two-part series was his experimental data on harmonic distortion due to saturation in a ferrite-core 1:1 balun. Although many have expressed concerns regarding saturation in ferrite-core baluns, Badger's data could very well be the only results available. He used the two-tone test method, which combined two RF sources of 2.001 and 2.003 MHz, amplified it to 2 KW PEP, and then fed it through a commercial 1:1 rod-type ferrite balun. The

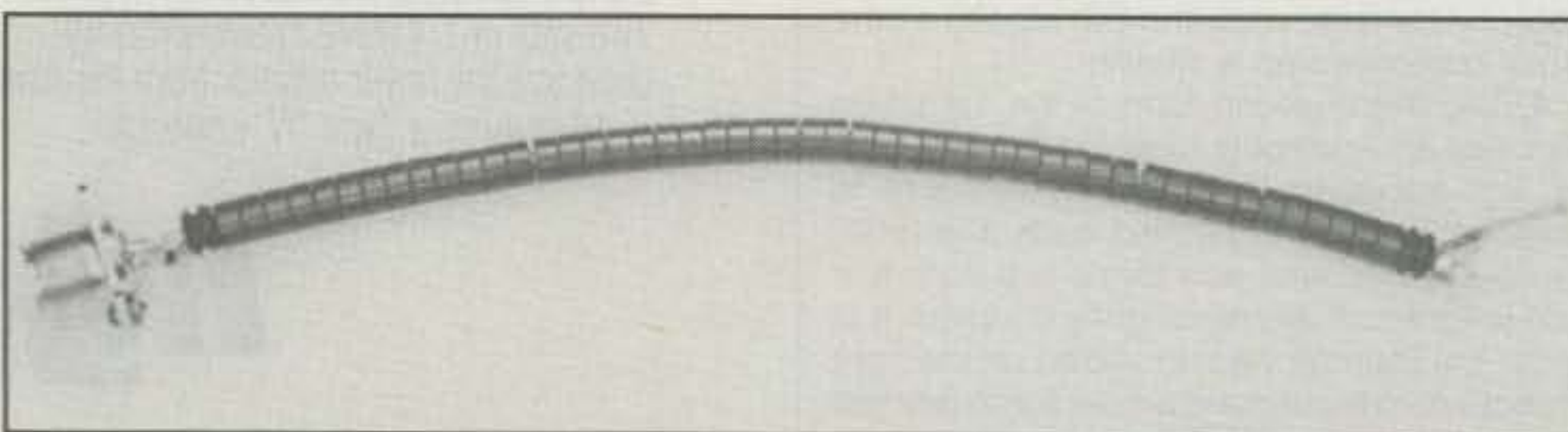

Photo E—The Maxwell, W2DU, "choke" 1:1 balun.

data showed considerable distortion in the 3rd order and the 9th order distortion products. In other words, appreciable non-linearity took place at this high-power level.

Several questions come to mind regarding these measurements. What was the low-frequency response of the commercial 1:1 rod-type balun he used? From my measurements on a rod-type balun (fig. 4), I found a drop in the input impedance and an inductive component at 2 MHz. This indicates flux in the core and a problem when using this balun at 2 MHz. Since many rod-type 1:1 baluns have been used over the years, it would have been instructive if he had also made these measurements at 4 and 7 MHz. They would have given the readers a safe lower-frequency limit for these baluns.

Also, why didn't Badger make similar measurements on Reiser's 1:1 balun, which he included in his articles? As noted earlier, I consider Reiser's 1:1 balun a very good design! I am sure that no distortion products would have been found at 2 MHz with it. The end result is that Badger chose a very poor ferrite-core design for making his comparisons. This helped contribute to an undeserved reputation for the ferrite-core balun.

Badger also suggested placing an insulated wire in parallel with the coax winding on Reiser's 1:1 balun. He called this a compensating winding, which provided a superior balanced output. The schematic is shown in fig. 6. Later experiments by the author and others have shown that a well-designed, two-conductor (Guanella) 1:1 balun has a completely satisfactory balanced output for antenna applications. Furthermore, it does not suffer from an unbalanced and/or mismatched load and core saturation. Incidentally, Badger's schematic of fig. 5 now adds up to four different versions of the 1:1 balun. They are the two-conductor version of Guanella's and the three, three-conductor versions of Ruthroff, Turrin, and (now) Badger.

Badger and Orr also mentioned the Collins balun in their articles. It is made up of a dummy length of coax which is wound as a continuation of the original coiled coax winding. Interestingly, it is connected as a Ruthroff 1:1 balun (fig. 2[B]), which also uses a third winding. Since there is appreciable coupling between the two coiled windings, the Collins balun should also be susceptible to mismatched and/or unbalanced loads. Badger claimed it was by far the best 1:1 balun he had ever used. Again, it would have been very informative if he had compared it with the Reiser balun (without the compensating third wire).

M. W. Maxwell, W2DU—1983. One of the more significant articles on 1:1 baluns was published by Maxwell in 1983.¹⁶ He introduced what he called the "choke" balun. It was formed by placing high-permeability ferrite beads over about one foot of small (but high-powered) coaxial cables similar to the ones used in the Reiser balun. Photo E shows the W2DU "choke" balun removed from its housing.

Maxwell compared his balun with (what he termed) a "transformer-type" balun by measuring the input impedances versus frequency when the outputs were terminated in 50 ohms. Since the "transformer-type" balun didn't yield a true 1:1 impedance transfer ratio, he claimed it was because of losses, leakage reactance, and less than optimum coupling. Since he gave no description of the "trans-

Spider Antenna

U.S. Patents 4348625, 4400990 Made in U.S.A.

Presenting the family of Spider™ Multi-Band Antennas

Four amateur bands (10, 15, 20, and 40 meters) at your command without having to change resonators or retune — just band switch your rig. Also available are the 75, 12, 17 and 30 meter bands. Needs no antenna tuner. Custom made with highest quality workmanship and materials.

Wherever you roam, on Land or Sea . . . or even at Home

On Land

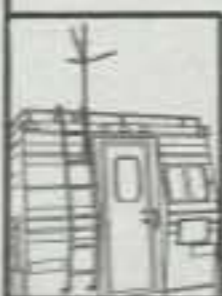

Suitable for use on any motor vehicle from a compact automobile to a motor home or trailer. Work four bands without stopping to change resonators.



Or Sea

The Spider™ Maritimer is for use on or near the ocean. Highly polished stainless steel and nickel-chrome plated brass. Commercial marine frequencies (8, 12, 16 and 22 MHz) are also available.

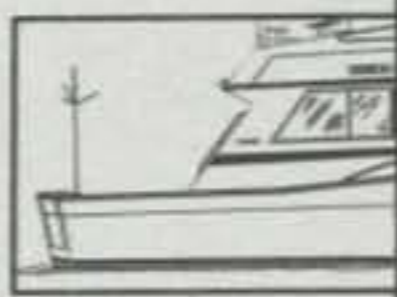

At Home



If you live in an apartment, condominium or restricted area, the Spider™ may well be the answer to your antenna problems.



MULTI-BAND ANTENNAS

7131 OWENSMOUTH AVENUE, SUITE 263C
CANOGA PARK, CALIFORNIA 91303
TELEPHONE: (818) 341-5460

DUPLEXERS

★ QUALITY ★ SERVICE
★ PRICE
WE'VE GOT IT ALL!

Our Bandpass-Reject Duplexers with our patented $B_p B_r$ Circuit® Filters provide superior performance . . . especially at close frequency separation.



PHONE 817-848-4435
FAX 817-848-4209

WACOM
PRODUCTS, INC.

P.O. BOX 21145 • WACO, TX 76702

CIRCLE 141 ON READER SERVICE CARD



Orders & Price Quotes

1-800-7OKHAMS

1-800-765-4267

ALINCO
ELECTRONICS INC.



FREE SHIPPING

UPS SURFACE On Purchases of \$50 or More (except Power Supplies and Antennas)

Local & Information

(405) 748-3066

FAX (405) 748-3077

13424 Railway Drive
Oklahoma City, OK 73114



Oklahoma owned and operated. Not affiliated with any other store

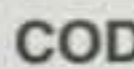

RF POWER AMPLIFIERS

NEW!
400 WATTS
AVG.
(144-148 MHz)

Model	Pin (W)	Pout (W)	Ic (A)	Gain/NF (dB)	(13.8 V) Type
50 MHz					
0503G	1-5	10-50	6	15/0.6	LPA
0508G	1	170	28	15/0.6	Standard
0508R	1	170	28	+	Repeater
0510G	10	170	25	15/0.6	Standard
0510R	10	170	25	+	Repeater
0550G	5-10	375	60	15/0.6	HPA
0550RH	5-10	375	60	+	Repeater HPA
0552G	25-40	375	55	15/0.6	HPA
0552RH	25-40	375	55	+	Repeater HPA
144 MHz					
1403G	1-5	10-50	6	15/0.6	LPA
1406G	25	100	12	15/0.6	Standard
1409G	2	150	25	15/0.6	Standard
1409R	2	150	24	+	Repeater
1410G	10	160	25	15/0.6	Standard
1410R	10	160	24	+	Repeater
1412G	25-45	160	20	15/0.6	Standard
1412R	25-45	160	19	+	Repeater
1450G	5	350	56	15/0.6	HPA
1450RH	5	350	56	+	Repeater HPA
1452G	25	350	50	15/0.6	HPA
1452RH	25	350	50	+	Repeater HPA
1454G	50-100	350	40	15/0.6	HPA
1454RH	50-100	350	40	+	Repeater HPA
220 MHz					
2203G	1-5	10-40	6	14/0.7	LPA
2210G	10	130	20	14/0.7	Standard
2210R	10	130	19	+	Repeater
2212G	30	130	16	14/0.7	Standard
2212R	30	130	15	+	Repeater
2250G	5	220	40	14/0.7	HPA
2250RH	5	250	40	+	Repeater HPA
2252G	25	220	36	14/0.7	HPA
2252RH	25	250	36	+	Repeater HPA
2254G	75	220	32	14/0.7	HPA
2254RH	75	250	32	+	Repeater HPA
440 MHz					
4403G	1-5	7-25	4	12/1.1	LPA
4410G	10	100	19	12/1.1	Standard
4410R	10	100	18	+	Repeater
4412G	20-30	100	19	12/1.1	Standard
4412R	20-30	100	18	+	Repeater
4448G	5	100	22	12/1.1	HPA
4448R	5	100	22	+	Repeater HPA
4450G	5-10	175	34	12/1.1	HPA
4450RE	5-10	175	34	+	Repeater HPA
4452G	25	175	29	12/1.1	HPA
4452RE	25	175	29	+	Repeater HPA
4454G	75	175	25	12/1.1	HPA
4454RE	75	175	25	+	Repeater HPA



MODEL 1410G
STANDARD



MODEL 1450G
HPA

All amplifiers (non-rptr) are linear, all-mode with fully automatic T/R switching and PTT capability. The receive preamps use GaAs FET devices rated at .5 dB NF with +18 dBm 3rd order IP. LPA, Standard and HPA amps are intermittent duty design suitable for base and mobile operation. Repeater amps are continuous duty, class C.

Amplifier capabilities: High-power, narrow or wideband; 100-200 MHz, 225-400 MHz, 1-2 GHz, Military (28V), Commercial, etc. - consult factory. A complete line of Rx preamps also available.

RX Preamplifiers

Band	Model	NF (dB)	Gain (dB)	Connector
50 MHz	0520B	.5	25	BNC
50 MHz	0520N	.5	25	N
144 MHz	1420B	.5	24	BNC
144 MHz	1420N	.5	24	N
220 MHz	2220B	.5	22	BNC
220 MHz	2220N	.5	22	N
440 MHz	4420B	.5	18	GNC
440 MHz	4420N	.5	18	N
1.2 GHz	1020B	.9	14	BNC
1.2 GHz	1020N	.9	14	N



Consult your local dealer or send directly for further product information. All Products Made in USA.

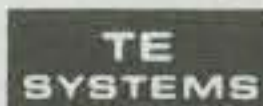

TE SYSTEMS TEL (310) 478-0591
P.O. Box 25845 FAX (310) 473-4038
Los Angeles, CA 90025

CIRCLE 130 ON READER SERVICE CARD

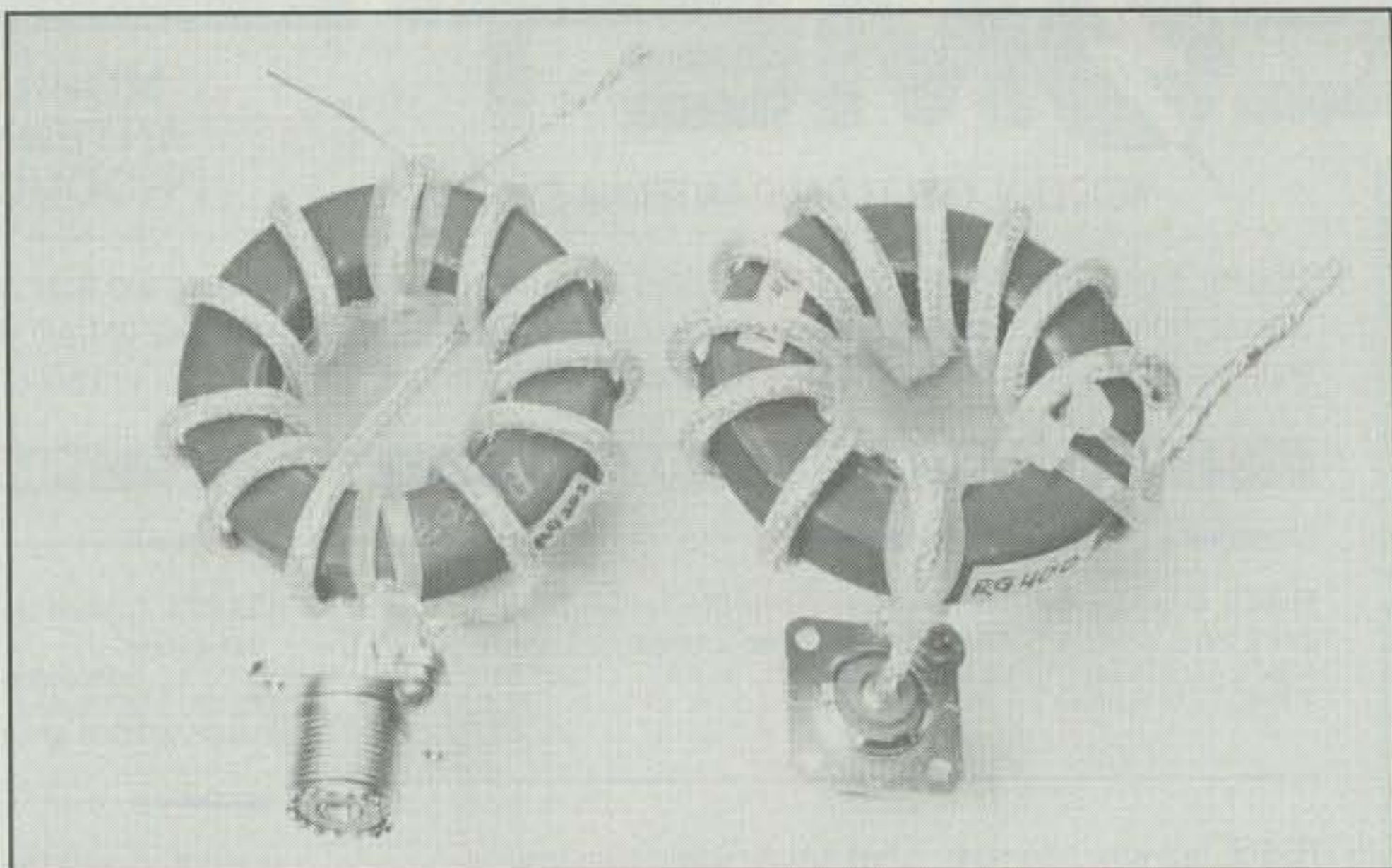

Photo F— Two versions of Reisert's 1:1 balun. The balun on the left uses the cross-over shown in fig. 5. The balun on the right is continuously wound. Both have the same electrical performance in the HF band.

former-type" balun, I assumed it was the popular rod-type balun shown in photo C. As you can see in fig. 4, this balun has a poor low-frequency response. Furthermore, it is really optimized for a load of 47 ohms and not 50 ohms.

But what Maxwell failed to realize was that his balun was a form of Guanella's two-conductor balun. That is, it is both a choke (a lumped element) and a transmission line (a distributed element). Additionally, Guanella's theory applies whether the transmission lines are coiled (about a core) or beaded or twin-

lead or coaxial cable. From Ruthroff's classic paper,⁹ which extended Guanella's work,⁸ we became aware of the voltage drops along the lengths of the transmission lines. And from very accurate insertion loss measurements,³ we learned that the losses were mainly in the magnetic medium and that they were related to the voltage levels and the permeabilities. Maxwell didn't take into account these latter findings. He used lossy high-permeability beads (2500) and assumed that the main loss was in the transmission line. He claimed that the CW pow-

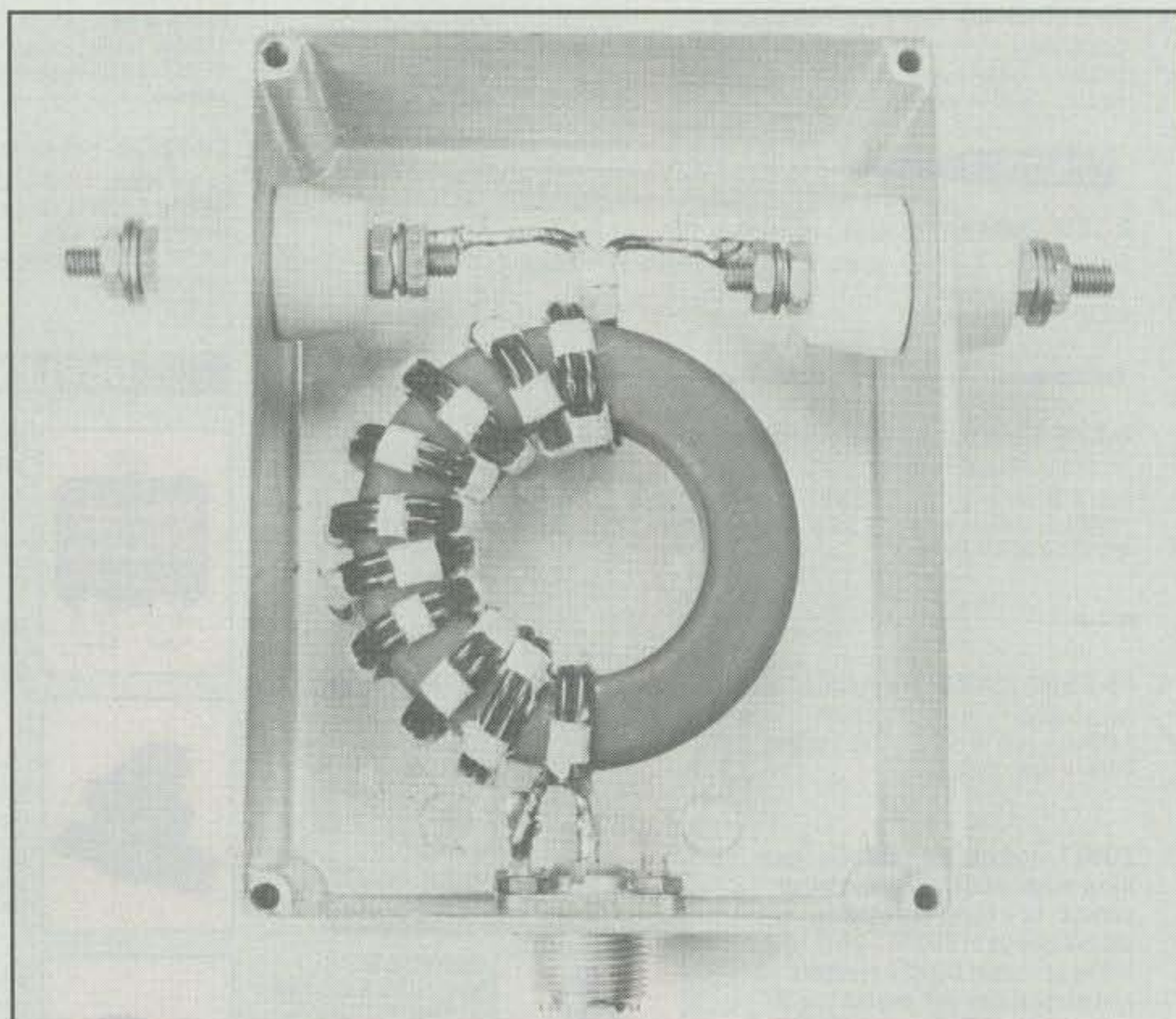

Photo G— My high-power design of a bifilar toroidal (Guanella/current) 1:1 balun mounted in a 4"L x 3"W x 2.25"H Bud aluminum box.

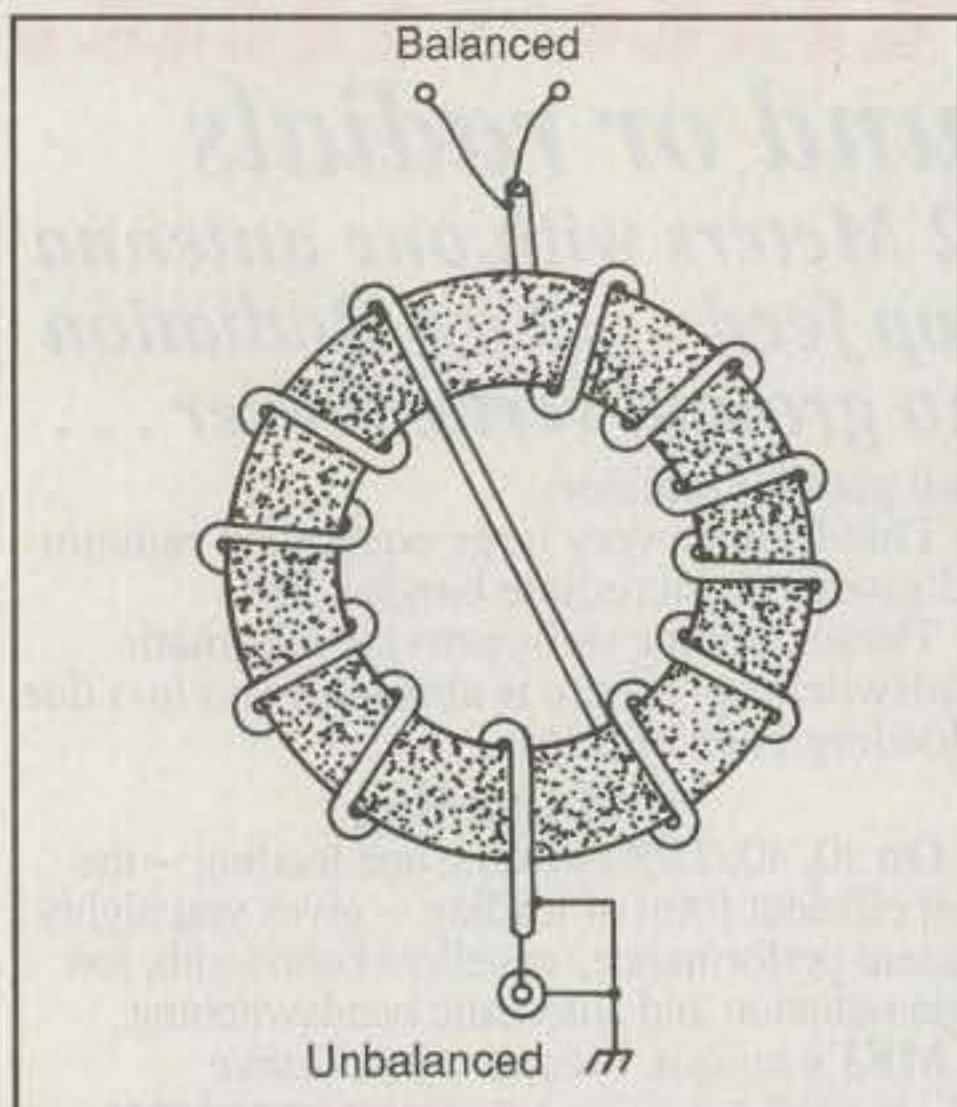

Fig. 5—A pictorial of the cross-over used in Reiser's 1:1 balun.

er-handling capability of his balun is 3.5 KW at 50 MHz and 9 KW at 10 MHz—the same as the coaxial cable itself. I seriously question these power ratings. Ironically, it is very likely that Maxwell's balun had *more* real loss than the so-called "transformer-type" balun!

R. W. Lewallen, W7EL—1985. There is very little doubt that Lewallen's interesting article¹⁷ in 1985 contributed significantly to the better understanding and design of 1:1 and 4:1 baluns. In it he coined the (now very popular) terms "voltage" and "current" baluns. The "voltage" balun, which is a three-conductor balun, has output ports which have voltages that are balanced to ground. It is brought about (see fig. 5) by the voltage-divider action of windings (5–6) and (1–2). Since we have two tightly-coupled transmission lines in the pass-band with the same potential gradients, terminal 6 is at $+V_1/2$ and terminal 4 is at $-V_1/2$, where V_1 is the input voltage. The "current" balun, on the other hand, is a two-conductor balun which causes equal and opposite currents on the output ports for any form of load impedance.

Lewallen conducted a series of experiments on 10 meters to compare the performances of "voltage" and "current" baluns under balanced and unbalanced conditions. In the unbalanced (nonsymmetrical) condition the dipole was lengthened by five inches on one side and shortened by five inches on the other side. He then obtained a figure of merit for both baluns (as well as for the case without a balun) defined as the ratio of the average magnitude of the currents at the feed point over the magnitude of the imbalance (the inverted L) current. The magnitudes of the cur-

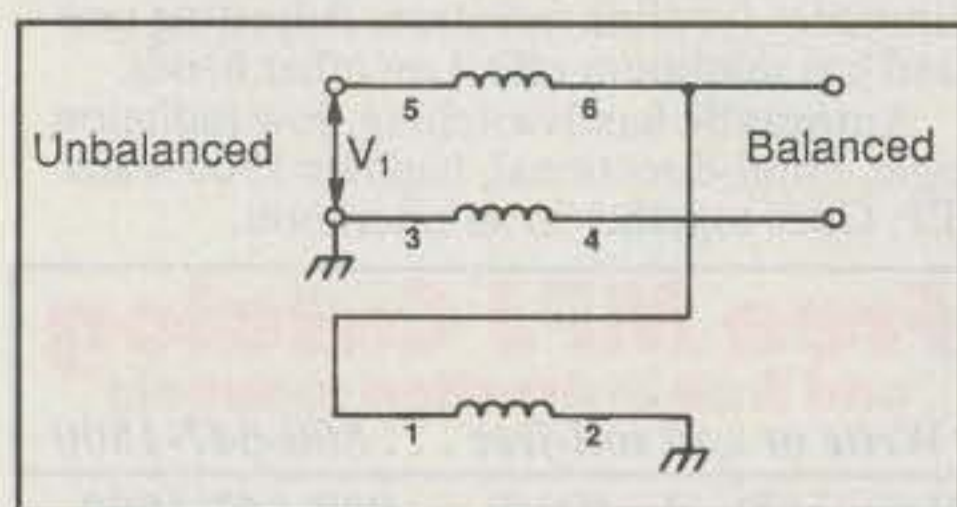

Fig. 6—Schematic of Badger's 1:1 balun with a compensating winding (1–2). Winding (3–4) is the outer-braid of the coax and winding (5–6) is the inner conductor.

rents were obtained by current-probe toroids. Measurements were made at the antenna feed point and at a half-wave (physically) from it.

The "current" balun consisted of 15 turns of very small RG-178U coax on a FT82-61 core (a ferrite toroid with an OD of 0.825 inches and a permeability of 125). The "voltage" balun had 10 turns of RG-178U coax with a No. 26 wire in parallel (closely coupled) on the same toroid. The schematic is shown in fig. 5.

Lewallen concluded (and I agree) that his experiments clearly showed that the "current" balun gave superior performance at every measured point in each experiment. However, the "voltage" balun still improved the balance over the no-balun case. He also concluded that other experiments should be performed in order to better compare the two forms of the balun. One is the difference when the feed line is placed nonsymmetrical with respect to the antenna (to induce an imbalance current into the feed line). Others include the optimum point in the feed line to place the balun and the various kinds of core and beaded baluns.

Although Lewallen's article pretty much speaks to Badger's proposal of adding a third wire to Reiser's balun for better balance (avoid it), there are some comments and questions I have regarding his experiments and findings. They are:

1. Why didn't he use Reiser's balun as the "current" balun and Badger's suggested third-wire design as the "voltage" balun? These would have been more realistic designs for comparisons. Instead, he used very small structures, which will find very little use, and as such have higher frequency capabilities. Also, since the "voltage" balun only had 10 turns (and hence a shorter transmission line and a poorer low-frequency response), it was favored in the comparisons on 10 meters. Had he used transmission lines of equal lengths, the differences between the two baluns would have been even more dramatic.

2. It would also have been very useful if Lewallen had made comparisons between a "current" balun that could handle the full legal limit of amateur radio power (again, like the Reiser balun) and "voltage" baluns such as the rod-type balun and the toroidal Turrin balun which have been readily available for nearly three decades.

3. Additionally, comparisons should not be limited to only 10 meters. Since "voltage" 1:1 baluns are configurations of coupled transmission lines with various characteristic impedances, their performances with mismatched and unbalanced loads are more sensitive to the higher frequencies than their "current" balun counterparts. Therefore, making similar measurements on 20 meters would also provide more useful information.

4. Even though Ruthroff's classic 1959 paper⁹ has been the industry standard over the years, his 1:1 balun design has been practically nonexistent in the amateur literature. Turrin mentioned its advantage over his first design in his second article.¹¹ However, Turrin's first design has prevailed in our amateur literature. Since Ruthroff's design has the third conductor on a separate part of the toroid, it has the balanced output mentioned by Badger¹³ but still retains the flexibility of the Guanella⁸ balun. In other words, as the frequency is increased, the choking action of the third wire makes it practically transparent. This enables it to handle any form of load imped-

ance. It would have been informative if Lewallen had pointed this out and also noted that Ruthroff's 1:1 balun, although looking like a "voltage" balun, is really a "current" balun.

5. Lewallen and the others who have published in the amateur radio literature failed to reference the first presentation on what is now known as "current" or "choke" baluns. It was by Guanella in 1944.⁸ Even though Guanella used coiled transmission lines without a magnetic core, his theory on how these devices work is still applicable today.

J. S. Belrose, VE2CV—1991. The last article on 1:1 baluns that I thought was worth mentioning was by Belrose in 1991.¹⁹ In it he described the W2DU balun by Maxwell and how his technique of threading coaxial cable through ferrite beads could easily be applied to 4:1 and 9:1 baluns.

What immediately caught my attention in this article were the editor's comments, which had *highly* complimentary remarks regarding the beaded-coax balun. In essence it said, "In this breakthrough article, W2DU's peerless 1:1 current-balun design serves as the basis for excellent ferrite-bead-choke current baluns capable of 4:1 and 9:1 impedance transformation."

If one reads the article carefully, however, it becomes apparent that Belrose did not say this. His words were, "The current balun of the type developed by Walt Maxwell, W2DU—a balun consisting of ferrite beads slipped over a length of coaxial cable—is the best so far devised." He did not say that W2DU's balun was "peerless." In fact, in the article he said just the opposite. He pointed out that the main disadvantage of the W2DU balun is that the beads are lossy at HF and that heating becomes a concern when the transmitting power exceeds 125 watts! For high power (1 KW CW) Belrose recommended Roehm's designs,²⁰ which use lower permeability (850) beads nearest the balun's balanced output (where most of the heating takes place).

I do, however, question two of the advantages he claims for the W2DU balun. They are:

1. Its excellent power-loss and impedance-versus-frequency characteristics are much superior to those of a bifilar current balun wound on a ferrite toroid.

2. It has excellent power-handling capability, and can function quite satisfactorily when working into highly reactive loads. This is so because the magnetic flux produced by currents flowing on this balun's wires cannot saturate its ferrite beads.

The first advantage listed above by Belrose was obtained by comparing the input impedance and power loss versus frequency of the W2DU balun with a commercial balun when they were terminated in 50 ohms. The commercial balun is a bifilar-wound toroidal type used in a differential-T tuner. What Belrose failed to realize was that the commercial balun had heavily insulated wires resulting in a characteristic impedance greater than 100 ohms. Thus, he was actually comparing a 50 ohm transmission line with a longer line that had a characteristic impedance in excess of 100 ohms! As expected, his input impedance versus frequency curve for the commercial balun was even more severe than that of the Turrin balun shown in fig. 4.

The second advantage listed above is based upon the premise that the magnetic flux produced by currents on the W2DU balun's

1994 CALLBOOKS



THE QSL Book!

Continuing over a 70 year tradition, we bring you two new Callbooks for 1994 with more features than ever before.

The 1994 North American Callbook lists the calls, names, and addresses for more than 500,000 licensed amateurs in all countries of North America, from Panama through Canada, including Greenland, Bermuda, and the Caribbean Islands, plus Hawaii and the U.S. possessions. 1,592 pages. Item # 087158 (paper) \$29.95

The 1994 International Callbook lists more than 500,000 licensed amateurs in countries outside North America. Its coverage includes South America, Europe, Africa, Asia, and the Pacific area (exclusive of Hawaii and the U.S. possessions). 1,720 pages. Item # 087190 (paper) \$29.95

Every active amateur needs the Callbook! Fully updated and loaded with extra features, the 1994 Callbooks will be published in December 1993. Order now from your dealer or send in the coupon below.

Please send me _____ copy(ies) of **The 1994 North American Callbook** (Item # 087158, \$29.95) and _____ copy(ies) of **The 1994 International Callbook** (Item # 087190, \$29.95).

I have enclosed my check/money order for \$_____. (Please add sales tax in CA, DC, IL, MA, NJ, NY, OH, PA, TN, VA & Canada, and \$3.00 per book for postage and handling for U.S. shipments and \$7.00 for all shipments outside the U.S.)

Or call and charge on your credit card. MasterCard, VISA and American Express cards accepted. Please be sure to include shipping instructions. Prepayment required and must be in U.S. funds.

DRAT 1093

RADIO AMATEUR callbook

P.O. Box 2013 Lakewood, NJ 08701
1-908-905-2961 (Phone) 1-908-363-0338 (Fax)

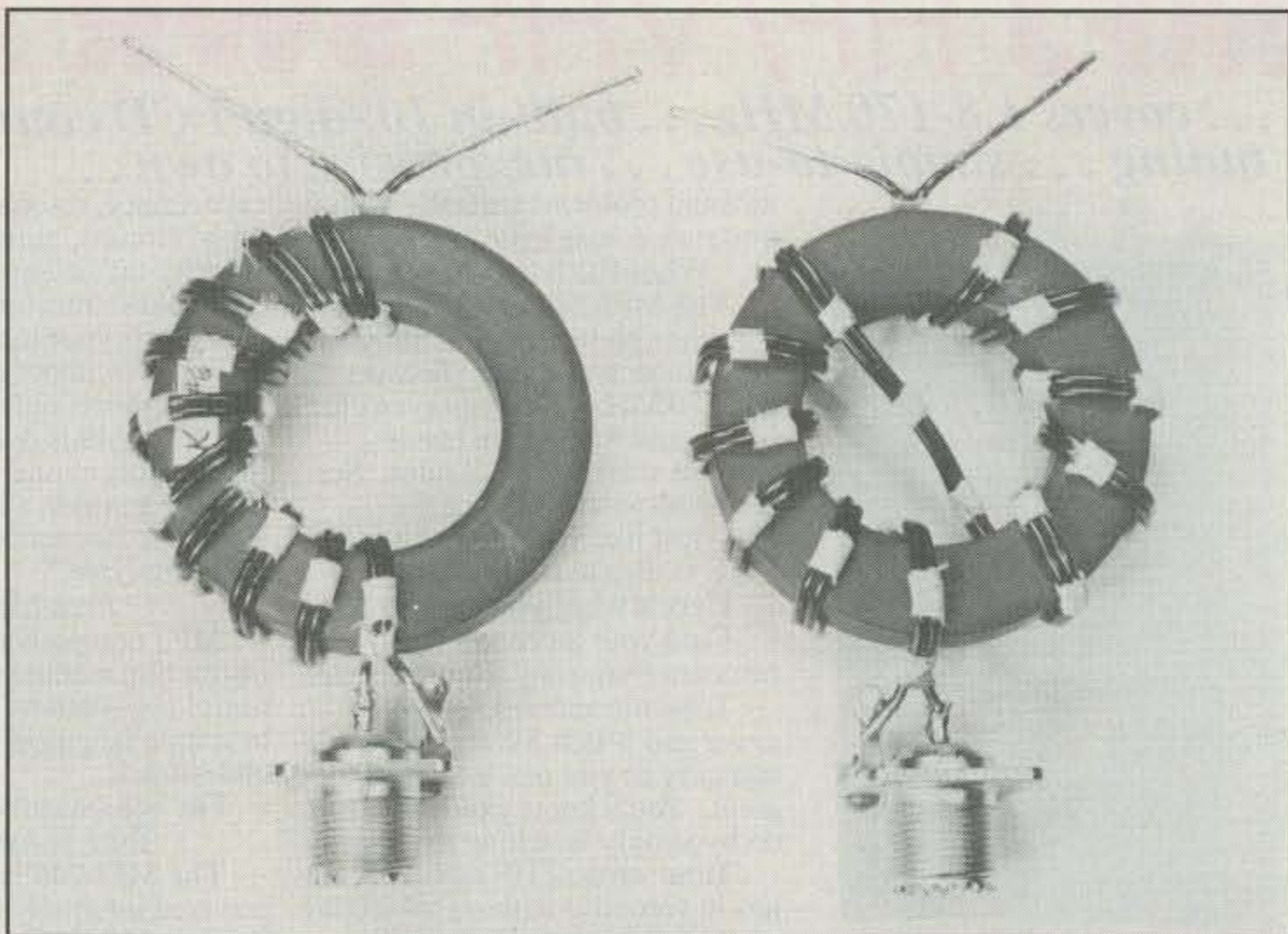

Photo H—Two "economy" versions of the high-power bifilar toroidal (Guanella/current) 1:1 balun. The one on the right uses Reisert's cross-over technique.

wires cannot saturate the ferrite beads while the windings of a bifilar-wound toroidal current balun can saturate the core. This is wrong because the magnetic flux of a two-conductor type balun such as the beaded-coax or the bifilar-wound toroidal balun is generated by the imbalance (inverted L) current and hence is *much* less than the transmission-line currents. This is especially true with sufficient choking reactances. This impression could very well come from the perception that the toroidal-type balun still transmits the energy to the output circuit by flux linkages.

For high-power beaded-coax baluns, Belrose referred to the designs by Roehm,²⁰ who increased the power capability of this type of balun by using lower permeability beads near the balanced output. He also increased the length considerably. For operation from 80 meters to 10 meters, he used 28 inches of beaded coax. For 160 meters to 10 meters, he used 36 inches of beaded coax. With Belrose's suggestion of connecting beaded coaxes in parallel on the low-impedance side and in series on the high-impedance side to obtain a broadband 4:1 transformation ratio, it would require transmission lines with characteristic impedances of 100 ohms. This means, for a high-power 4:1 balun using beaded transmission lines, about 56 inches of beaded line would be required for the 80 to 10 meter operation and 72 inches for the 160 to 10 meter coverage. For a 9:1 balun these lengths would even have to be increased by 50 percent!

The question that remains is what would Belrose have said or done if he had compared the W2DU balun of Maxwell's with the W1JR balun of Reisert's. He certainly couldn't claim the advantages listed in his article for the W2DU balun. Would he still have said that the type of balun developed by Maxwell is the best so far devised? I doubt it.

J. Sevick, W2FMI—1994. In keeping with the preceding format, I thought it best to present my latest 1:1 balun designs at this point.

(Kits and finished units are available from Amidon Associates, Inc., 2216 East Gladwick Street, Dominguez Hills, CA 90220.) Except for one balun that appeared in the June 1993 issue of *CQ*, the others are presented here for the first time. Since I have favored Reisert's design throughout this article, the first baluns described here are my versions of his technique of coiling small (but high power) coaxial cable around a low-permeability ferrite toroid. For my wire versions I could have used all sorts of adjectives to describe them, such as Guanella, two-conductor, choke, and current. But in the process of writing this section, I thought Belrose's adjectives were the most direct. Using his words, I call my wire versions of the 1:1 balun simply *bifilar toroidal baluns*.

Photo F shows two versions of Reisert's balun. The one on the left uses the cross-over shown in fig. 5. Since no difference in performance at HF was noticed without the cross-over, a continuous-wound one is also shown on the right. The main advantage in the HF band with the cross-over winding is purely mechanical. Having the input and output connections on opposite sides of the toroid is not only more convenient, but it also offers a much stronger method of mounting.

For operation from 1.8 MHz to 30 MHz, 10 turns of small coax such as RG-303/U, RG-142B/U, or RG-400/U are wound on a 2.4 inch OD ferrite toroid with a permeability of 250. If the use is limited from 3.5 MHz to 30 MHz, then a permeability of 125 is recommended, since it would yield a slightly higher efficiency at the high end. If one wants the highest possible efficiency and limits the operation from 14 MHz to 30 MHz, then a permeability of 40 is recommended. With loads grounded at their centers, these conditions were found to give ample margins (handle a VSWR of 3:1 without any appreciable flux) at their low-frequency ends.

For ease of winding, I found the TY-RAP CABLE TIES very useful. Two were used at

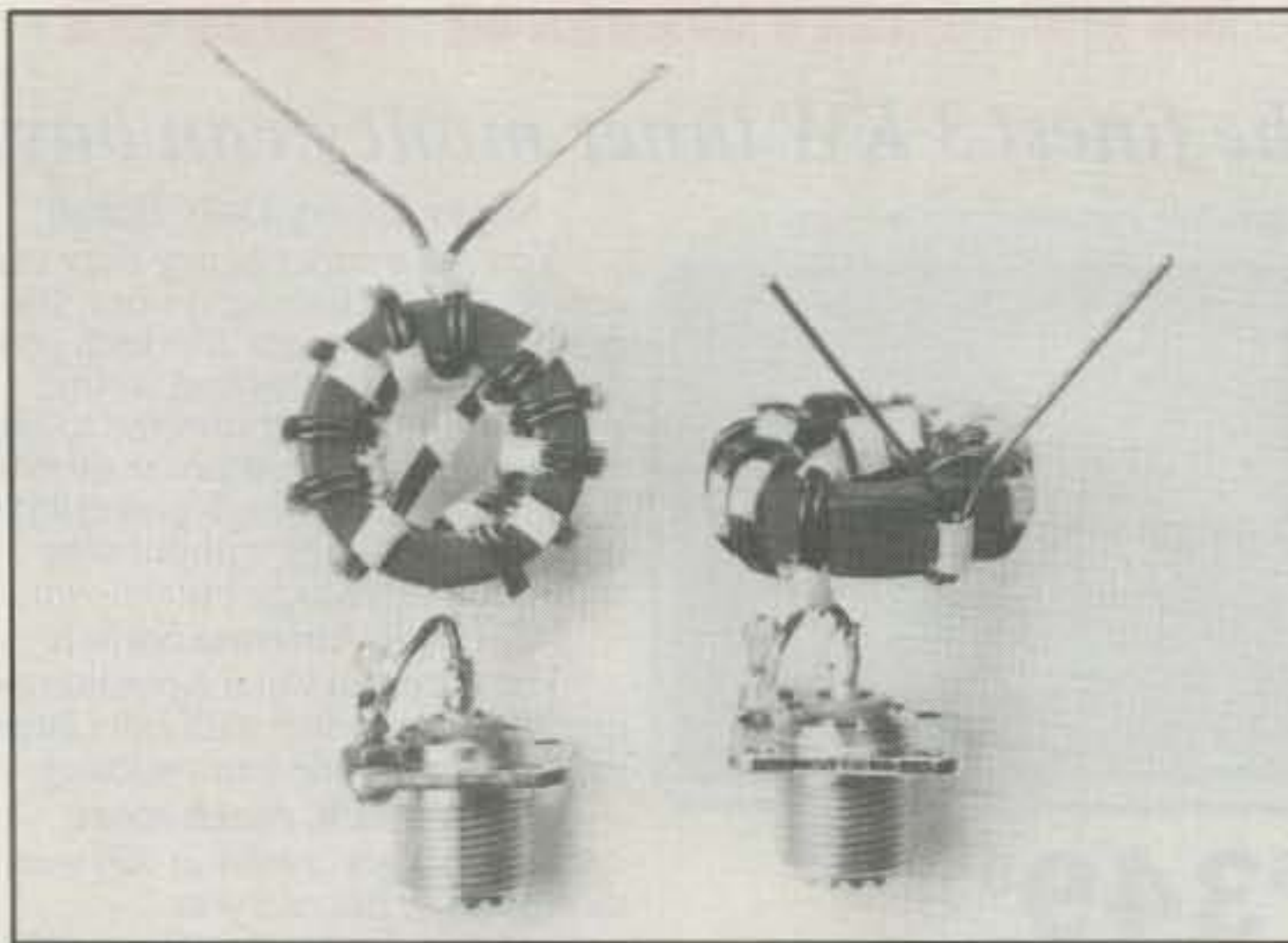

Photo I— Two low-power versions of the bifilar toroidal (Guanella/current) 1:1 balun capable of handling the output of practically any HF transceiver. The balun on the left has the cross-over.

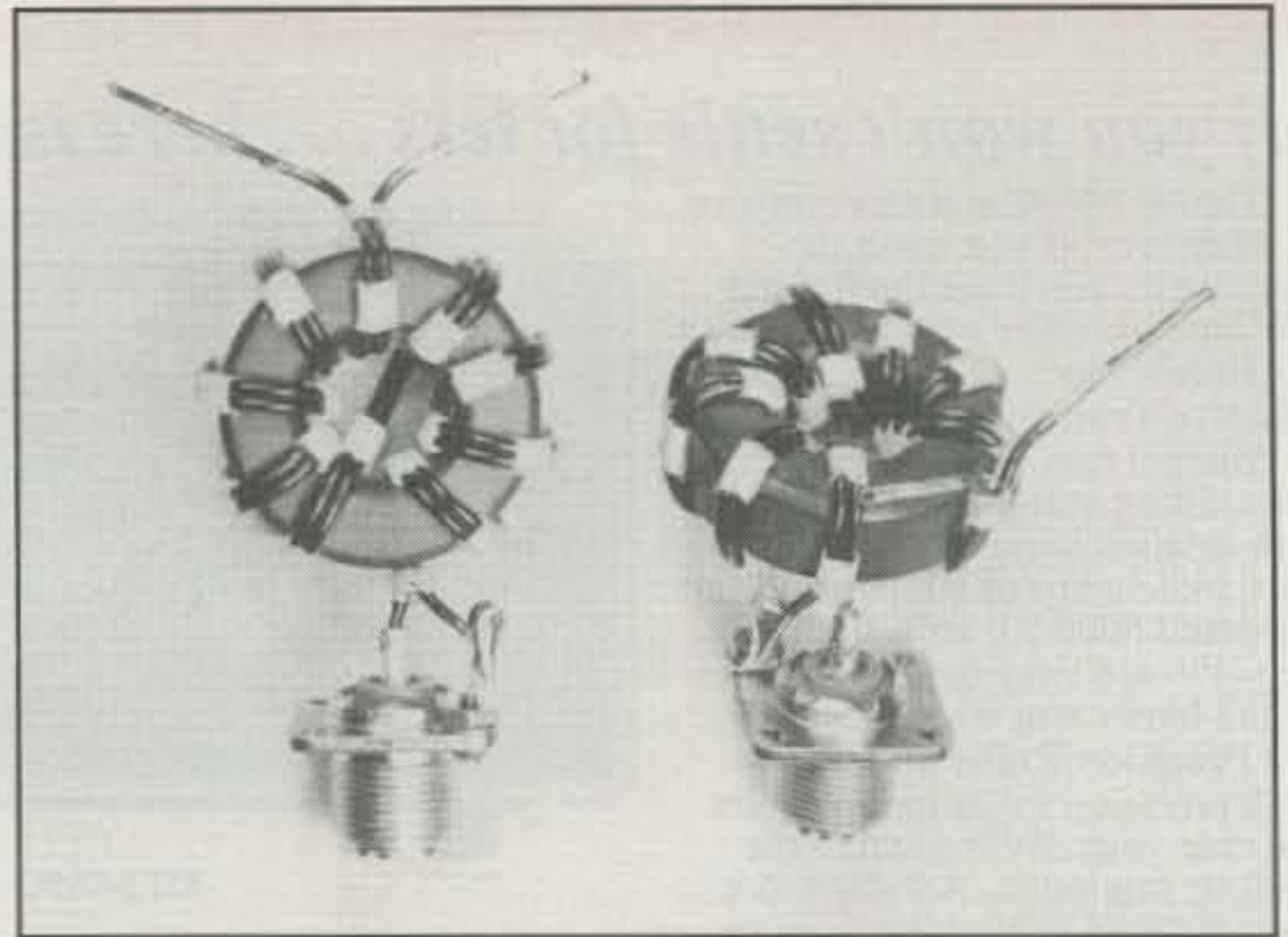

Photo J— Two medium-power versions of the bifilar toroidal (Guanella/current) 1:1 balun capable of handling the full legal limit of amateur radio power when the VSWR is less than 2:1. The balun on the left has the cross-over.

each end. Also removing the covering on the outer braid helps. Since about 24 inches of cable is wound on the toroid, starting with at least 32 inches is recommended. Of the three cables noted above, I found RG-303/U cable the easiest to wind and connect. Although it only has a single-thickness braid (the others have double-thickness braids), its power rating is still the same—9 KW at 10 MHz and 3.5 KW at 50 MHz.

The next high-power design is shown in photo G mounted in a 4"L x 3"W x 2.25"H Bud CU 234 aluminum box. It has 10 bifilar turns of No. 12 H Thermaleze wire on a 2.4 inch OD ferrite toroid. As with the Reisert versions before, a permeability of 250 is recommended for 1.8 to 30 MHz, 125 for 3.5 to 30 MHz, and 40 for 14 to 30 MHz. One wire is also covered with two layers of Scotch No. 92 polyimide tape in order to raise the characteristic impedance to 50 ohms. With this added insulation, the voltage breakdown of this twin-lead transmission line compares very favorably with RG-8/U cable (4000 volts). In order to preserve the spacing, the wires are also clamped together about every 1/2 inch with strips of Scotch No. 27 glass tape 3/16 inches wide and a little over 1 inch long.

Two "economy" versions of the high-power bifilar toroidal balun are shown in photo H. The one on the left shows the windings crowded on one-half of the toroid. The one on the right has the same positions of the input and output connections by using the cross-over. Their performances are identical. Both baluns have 10 bifilar turns of No. 14 H Thermaleze wire on a 2.4 inch OD ferrite toroid. The choices of permeability, which trade-off bandwidth for efficiency, are the same as those used in the two previous high-power designs. As was mentioned at the beginning, the word "economy" refers to economy in labor.

This balun, which also handles the full legal limit of amateur radio power, has a small trade-off in high-frequency response. Since no extra insulation is used, the characteristic impedance of two tightly-clamped No. 14 H Thermaleze wires is 45 ohms. With one layer of Scotch No. 92 tape it increases to 50 ohms. But for most of the HF band, the difference in perfor-

mance between baluns using transmission lines of 45 and 50 ohms should be negligible. Even without the extra insulation the voltage breakdown should compare very favorably with the smaller, high-power coaxes used in the Reisert versions (1900 volts).

Photo I shows two low-power versions of a bifilar toroidal balun capable of handling the output of practically any HF transceiver. One has a cross-over winding and the other a continuous winding. They both have 10 bifilar turns of No. 16 H Thermaleze wire on a 1.25 inch OD ferrite toroid with a permeability of 250. Since efficiency is not a major problem in low-power use, I found no reason to suggest the other two versions, which use lower permeabilities. It is interesting to note that two tightly clamped No. 16 H Thermaleze wires have a characteristic impedance close to 50 ohms. Therefore, this small balun (particularly with its short leads) has a very good high-frequency response.

Photo J shows two medium-power versions of a bifilar toroidal balun capable of handling the full legal limit of amateur radio power under controlled conditions—when the VSWR is less than 2:1. Being smaller than its larger (2.4 inch OD) counterpart, its heat-sinking capability, and hence power rating, is less. As before, one balun uses a cross-over while the other does not. Each has 8 bifilar turns of No. 14 H Thermaleze wire on a 1.5 inch OD ferrite toroid. The ferrite permeabilities and expected bandwidths are the same as with the other high-power baluns. Since the average magnetic path length in the core is about two-thirds that of the 2.4 inch core, only 8 bifilar turns are required in order to produce a similar low-frequency capability. Even though the characteristic impedances of their bifilar windings are 45 ohms, their responses on 10 meters should be somewhat better than the "economy" models, since the lengths of their transmission lines are shorter (18 compared to 24 inches).

And now a few words on what sort of efficiency one can expect in trading-off low-frequency response by using lower permeability ferrite cores. From earlier studies³ it was found that the efficiency (with sufficient choking so only transmission line currents flow) is related to the permeability, the voltage drop along the

length of the transmission line, and the frequency. The higher the permeability and/or voltage, the greater the loss. Additionally, the higher the permeability, the greater is the loss with frequency. It was also found that a permeability of less than 300 was necessary in order to obtain the very high efficiencies of which these devices are capable.

From the results of the studies, here are some efficiencies that might be expected from ferrites under matched conditions:

1. With 250 material, an efficiency near 99 percent at 1.8 MHz and 97 percent at 30 MHz.
2. With 125 material, an efficiency near 99 percent at 3.5 MHz and 98 percent at 30 MHz.
3. With 40 material, an efficiency of 99 percent at 14 MHz and at 30 MHz.

When a balun is exposed to a high impedance resulting in a VSWR of 2:1, the voltage, and hence loss, increases by about 40 percent. With a VSWR of 4:1 the loss doubles. With a VSWR of 10:1 the loss is more than threefold. Since limited data was obtained in this study,³ these increases in losses with increases in VSWR could very well be greater.

Summary

In preparing this article I was quite surprised to still see the ferrite- and powdered-iron-core 1:1 balun designs that have been available in the literature and elsewhere since 1964. They not only had poor low- and high-frequency responses, but they were also susceptible to flux in the cores at their low-frequency ends. Furthermore, since they only used single-coated wires, they were also prone to voltage breakdown. No doubt, these designs were responsible for the poor reputation that the balun has had for many years.

It wasn't until 1978, when Reisert published his article, that a balun became available with all of the attributes of a good design, namely:

- a) Is efficient because it uses a low-permeability core.
- b) Has sufficient choking reactance to meet its low-frequency requirement.
- c) Is not prone to flux in the core (and hence, saturation) since it has no third winding.

d) Has a 50 ohm characteristic impedance and thus maintains a 1:1 transformation ratio with a 50 ohm load.

e) Has a good voltage breakdown capability (1900 volts).

f) Can handle a mismatched and/or unbalanced load.

Succeeding investigators, however, failed to see the advantages of his design and proposed their own. Surprisingly, they belonged to two distinct groups. One favored "air-core" baluns and the other "choke" (beaded-coax) baluns.

The main argument given by the "air-core" followers was that their balun would never experience the problems with saturation while the "ferrite-core" balun would. The Reisert balun, however, is a current/choke type balun which could only have flux in the core by the imbalance (inverted L) current, which is much smaller than the transmission-line currents. In fact, with any degree of choking reactance by the coiled transmission line, the imbalance current is essentially negligible. Therefore, saturation is not a concern with a balun such as Reisert's. But in all fairness, it should be pointed out that with the 4:1 current/choke and voltage baluns it is a different story. All three of these types of baluns have a "magnetizing inductance" in their low-frequency models and hence a possibility of saturation with a poor design.

The advocates of the "choke" 1:1 balun claim that their beaded-coax balun can't sat-

urate, while the bifilar (current) toroidal balun can. This is entirely wrong, since they are basically the same kind of structure—neither has a third conductor which could allow a flux-causing current at the very low-frequency end. But of all of the attributes listed above for the Reisert balun, the first one has the "choke" balun at a disadvantage in the HF band. Since its transmission line is not coiled about a toroid, it does not have the multiplication factor of N^2 (due to mutual coupling), where N is the number of turns, while the toroidal balun does. Therefore, higher-permeability beads are required in order to obtain sufficient choking reactance. This results in lower efficiency.

And finally, I am quite sure that some readers of this article will disagree with my views and/or think they have better designs than those of the Reisert baluns and the ones I presented here. If so, I encourage them to respond in print. In this way we will all benefit from the new information.

References

1. Jerry Sevick, W2FMI, "More on the 4:1 Balun," *CQ*, February 1994, pages 28-36.
2. Jerry Sevick, W2FMI, "Baluns Revisited," *Communications Quarterly*, Summer 1992, pages 13-18.
3. Jerry Sevick, W2FMI, *Transmission Line Transformers*, 2nd edition, Amateur Radio Relay League, Newington, Connecticut, 1990.
4. Jerry Sevick, W2FMI, "The 2:1 Unun

Matching Transformer," *CQ*, August 1992, pages 13-18.

5. Jerry Sevick, W2FMI, "A Balun Essay," *CQ*, June 1993, pages 50-59.

6. Richard A. Genaille, W4UW, "How to Build a Multi-Tap Unun," *CQ*, May 1992, pages 28-32.

7. Bruce Eggers, WA9NEW, "An Analysis of the Balun," *QST*, April 1980, pages 19-21.

8. G. Guanella, "Novel Matching Systems for High Frequencies," *Brown-Boveri Review*, Volume 31, September 1944, pages 327-329.

9. C. L. Ruthroff, "Some Broad-Band Transformers," *Proceedings of the IRE*, Volume 47, August 1959, pages 1337-1342.

10. Richard H. Turrin, W2IMU, "Broad-Band Balun Transformers," *QST*, August 1964, pages 33-35.

11. Richard H. Turrin, W2IMU, "Application of Broad-Band Balun Transformers," *QST*, April 1969, pages 42, 43.

12. Joe Reisert, W1JR, "Simple and Efficient Broadband Balun," *Ham Radio*, September 1978, pages 12-15.

13. George Badger, W6TC, "A New Class of Coaxial-Line Transformers, Part 1," *Ham Radio*, February 1980, pages 12-18.

14. George Badger, W6TC, "A New Class of Coaxial-Line Transformers, Part 2," *Ham Radio*, March 1980, pages 18-29, 70.

15. Bill Orr, W6SAI, "Radio Fundamentals: The Coax Balun," *CQ*, November 1993, pages 60-65.

16. Walt Maxwell, W2DU, "Some Aspects of the Balun Problem," *QST*, March 1983, pages 38-40.

17. Roy Lewallen, W7EL, "Baluns: What They Do and How They Do It," *The ARRL Antenna Compendium*, Volume 1, Amateur Radio Relay League, Newington, Connecticut, 1985, pages 12-15.

18. Jerry Sevick, W2FMI, "Baluns for Antenna Tuners," *CQ*, November 1993, pages 50-59.

19. John Belrose, VE2CU, "Transforming the Balun," *QST*, June 1991, pages 30-33.

20. Albert Roehm, W2OBJ, "Some Additional Aspects of the Balun Problem," *The ARRL Antenna Compendium*, Volume 2, Amateur Radio Relay League, Newington, Connecticut, pages 172-174. ■

Check out our NEW \$40 Special To Charge You Up...

Periphex Power Packs for Longer QSO Time

replacements for	regular price
FNB-26 YAESU 1000ma	\$ 60.00
BP-84S ICOM 1400ma	\$ 63.00
PB-7S KENWOOD 1400ma	\$ 59.00
EBP-24S ALINCO 1500ma	\$ 62.00

Now Only \$40 Each

- One Year Warranty
- Matched cell construction
- Case re-build service
- Long life, extended operating time
- Made for HAMS, by HAMS

Add \$4.00 Shipping & Handling for first battery. \$1.00 for each add'l battery - U.S. only. Connecticut residents add 6% tax.

PERIPHEX inc.
the only thing low about our charge is the cost...
1-800-634-8132

115-1B Hurley Road • Oxford, CT 06478 • (203) 264-3985 • FAX (203) 262-6943

Correction To February Article

In the February issue of *CQ* on page 28, "A Subsequent Look At 4:1 Baluns," also by W2FMI, fig. 2 was incorrect. The pictorial representation of the 4:1 Ruthroff (voltage) balun is as shown here.

