

# THE ARRL ANTENNA BOOK



PUBLISHED BY THE  
AMERICAN RADIO RELAY LEAGUE

**\$5.00**

# The ARRL Antenna Book



Edited by  
Gerald L. Hall, K1TD

Published by  
THE AMERICAN RADIO RELAY LEAGUE, INC.  
Newington, Connecticut

*Copyright © 1974 by*

**THE AMERICAN RADIO RELAY LEAGUE, INC.**

*Copyright secured under the Pan-American Convention*

**International Copyright secured**

This work is Publication No. 15 of The Radio Amateur's Library, published by the League. All rights reserved. No part of this work may be reproduced in any form except by written permission of the publisher. All rights of translation are reserved. Printed in U.S.A.

*Quedan reservados todos los derechos*

*Thirteenth Edition  
Fifth Printing, 1980*

*Library of Congress Catalog Card Number: 55-8966*

*\$5.00 in U.S.A.  
\$5.50 elsewhere*

# CONTENTS

	Foreword . . . . .	5
Chapter 1	Wave Propagation . . . . .	7
2	Antenna Fundamentals . . . . .	24
3	Transmission Lines . . . . .	68
4	Multielement Directive Arrays . . . . .	130
5	Long-Wire Antennas . . . . .	165
6	Multiband Antennas . . . . .	178
7	Antennas for 1.8 MHz . . . . .	189
8	Antennas for 3.5 and 7 MHz . . . . .	195
9	Antennas for 14, 21, and 28 MHz . . . . .	202
10	HF Antennas for Restricted Space . . . . .	211
11	VHF and UHF Antenna Systems . . . . .	224
12	Antennas for Space Communications . . . . .	250
13	Construction of Wire Antennas . . . . .	264
14	Rotatable Antennas . . . . .	277
15	Mobile Antennas . . . . .	287
16	Specialized Antennas . . . . .	293
17	Measurements . . . . .	301
18	Finding Directions . . . . .	323
	Index . . . . .	331

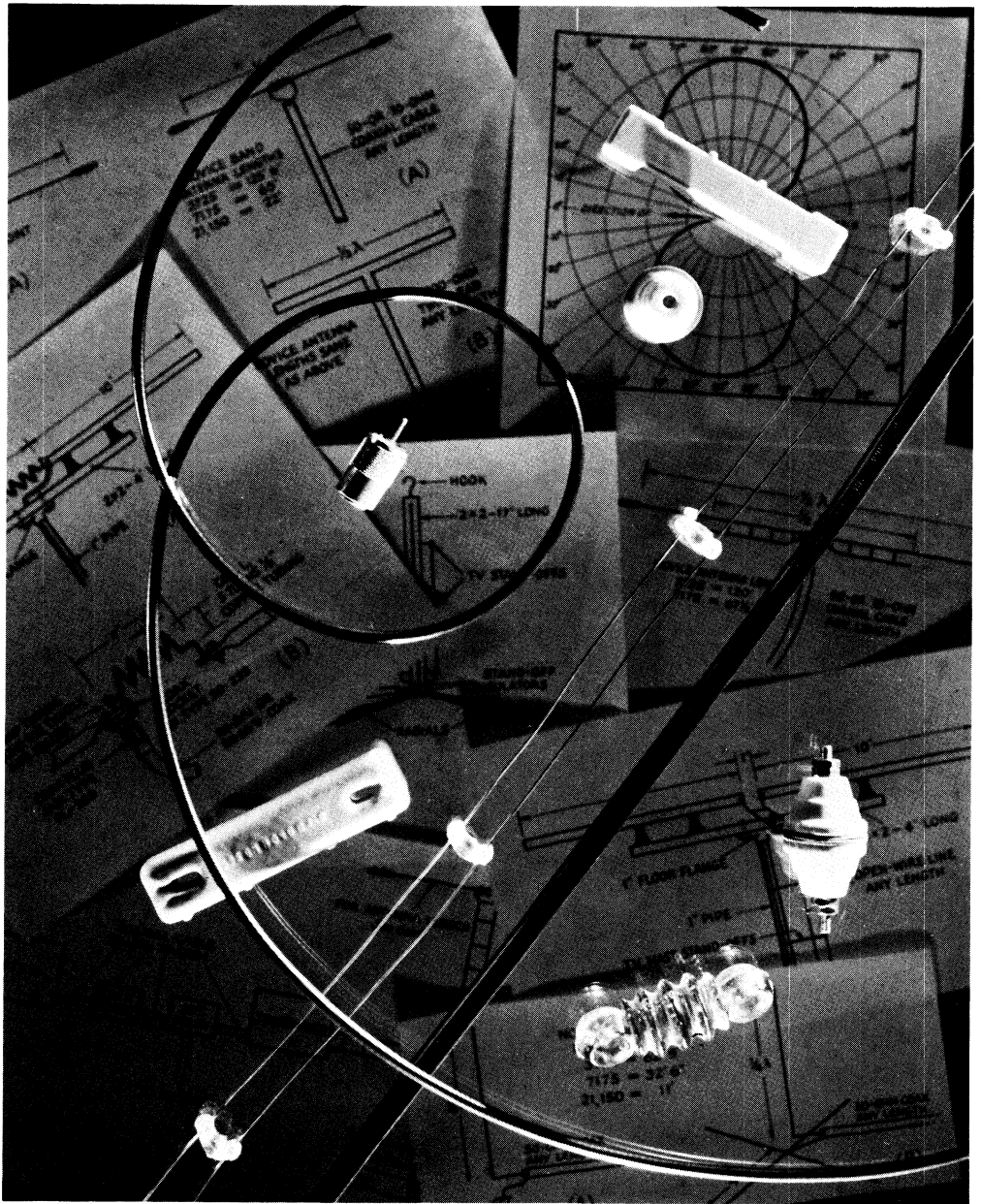

# FOREWORD

Radio amateurs are people with diversified interests, ranging from low frequencies to uhf and above, through radiotelephony, code operation, and teletype to television, from the sociability of “rag chewing” and the excitement of contests to handling traffic for the public benefit. In all these activities there is one common element – the antenna. It is fair to say that the ultimate success of the station is in most cases determined more by the antenna than by any other single category of equipment.

It is the purpose of this volume to assemble such of the available information on antennas as may be useful to amateurs. The subject has many ramifications, and consideration of the antenna alone is not enough: To be able to choose an antenna intelligently one must know something about how radio waves travel, because the energy radiated must be properly directed if it is to do the most good; one must also know something about transmission lines, because power can be wasted between the transmitter and antenna if the two are not properly connected. Wave propagation and transmission lines therefore require detailed treatment along with the antenna itself. There is no one “best” antenna system for all purposes, but with the help of the information in this book any amateur should be able to take the three steps that lead to a successful installation – first, to determine the things the antenna must do if it is to provide the best communication between two points; second, to choose the type of antenna that best meets the requirements; and third, to select a suitable method of transferring power from the transmitter to the antenna.

The book has three principal divisions. Chapters One through Five deal with the principles of antennas and transmission lines, wave propagation and its relationship to antenna design, and the performance characteristics of directive antenna systems. Beginning with Six, there is a series of chapters in which complete data are given on specific designs for the various amateur bands, including those suitable for space communications – satellites, moonbounce, meteor scatter, etc. The remaining chapters deal with the highly important mechanical features of construction and related subjects such as measurements and determining geographical directions.

It is sincerely hoped that you will find the work helpful. If there are some things left untreated that you wish to know more about, some things you do not understand, we shall be grateful if you, the user of the book, will give us your suggestions on how a future edition can be made even more valuable to you.

Newington, Connecticut

Richard L. Baldwin, W1RU  
*General Manager, ARRL*

# Wave Propagation

Because radio communication is carried on by means of electromagnetic waves traveling through the earth's atmosphere, it is desirable to know something about the characteristics of waves and the way in which their behavior is influenced by the conditions they meet in their trip from the radio transmitter to the receiver. While a detailed knowledge of wave propagation is not at all essential to the amateur who wants to put up an effective antenna, a few facts must be understood before the principles of antenna design can be intelligently applied. An antenna may – and usually does – radiate the power applied to it with a high degree of efficiency, but if that power does not travel to the desired receiving point but goes somewhere else instead, the antenna is a failure.

Our purpose in this chapter, therefore, is to discuss those features of wave propagation that have some bearing on the design of an antenna system. In doing this we do not mean to imply that there is nothing more that the wide-awake amateur will want or need to know about the subject. Effective radio communication results from a combination of equipment, antenna system, *and* operating skill, which must include that ability to anticipate “conditions” – a skill that is based on an understanding of the vagaries of wave propagation. But the latter, fascinating though they are, are somewhat outside the scope of this book when they do not directly affect antenna design.

## WAVE CHARACTERISTICS

The reader who has some knowledge of electricity has already been introduced to the idea of electric and magnetic fields. A radio wave is a special combination of both types of fields, with the energy divided equally between the two. If the waves could originate at a point source in “free” space – empty space such as occurs, for all practical purposes, in the interplanetary and interstellar stretches of the universe – they would spread out in ever-growing spheres with the source as the center. The speed at which the spheres expand would be the same as the speed of light,

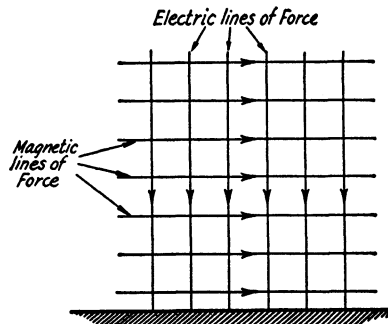

Fig. 1-1 — Representation of the magnetic and electric fields of a vertically polarized plane wave traveling along the ground. The arrows indicate instantaneous directions of the fields for a wave traveling perpendicularly out of the page toward the reader. Reversal of the direction of one set of lines reverses the direction of travel. There is no change in direction when both sets are reversed. Such a dual reversal occurs, in fact, once each half cycle.

since light also is an electromagnetic wave. In empty space this speed is 299,793,077 meters or 186,282,386 miles per second. In normal use for calculations these figures may be rounded off to 300,000,000 meters per second and 186,000 miles per second, and these latter values will be used throughout the remainder of this book. The path of a ray from the source to any point on the spherical surface always is a straight line – a radius of the sphere.

It is obvious that in a remarkably short time a sphere growing outward from the center would be very large indeed. An observer on such a spherical surface would conclude, if he could “see” the wave in his vicinity, that it does not appear to be spherical at all but instead seems like a flat surface – just as the earth seems to human beings to be flat rather than spherical. A wave that is far enough from the source to appear flat is called a plane wave. The radio waves with which we deal in communication always meet this condition, at least

after they have traveled a short distance from the transmitting antenna.

A typical representation of the lines of electric and magnetic force in a plane wave is given in Fig. 1-1. The nature of wave propagation is such that the electric and magnetic lines always are mutually perpendicular, as indicated in the drawing. The plane containing the set of crossed lines represents the wave front. The direction of wave travel always is perpendicular to the wave front, but whether the direction is "forward" or "backward" is determined by the relative directions of the electric and magnetic forces.

If the wave is traveling through anything other than empty space its speed is not 300,000,000 meters per second but is something less. Just how much less depends on the substance or medium through which the wave is traveling. If the medium is air instead of empty space, the reduction in speed is so small that it can be ignored in most calculations. In solid insulating materials the speed is generally much slower; for example, in distilled water (which is a good insulator) the waves travel only one-ninth as fast as they do in space. In good conductors such as metals the speed is so low that the opposing fields set up by currents induced in the conductor by the wave itself occupy practically the same space as the original wave and thus almost cancel it out. This is the reason for the skin effect in conductors at high frequencies and also the reason why thin metal enclosures form good shields for electrical circuits at radio frequencies.

### Phase and Wavelength

Because the speed at which radio waves travel is so great, we are likely to fall into the habit of ignoring the time that elapses between the instant at which a wave leaves the transmitting antenna and the instant at which it arrives at the receiving antenna. It is true that it takes only one seventh of a second for a wave to travel around the world, and from a communication standpoint that is hardly worth worrying about. But there is another consideration that makes this factor of *time* extremely important.

The wave is brought into existence because an alternating current flowing in a conductor (which is usually an antenna) sets up the necessary electric and magnetic fields. The alternating currents used in radio work may have frequencies anywhere from a few tens of thousands to several billion hertz. Suppose that the frequency is 30 megahertz (MHz) — that is, 30,000,000 hertz (Hz). One of the cycles or periods will be completed in 1/30,000,000 second, and since the wave is traveling at a speed of approximately 300,000,000 meters per second it will have moved only 10 meters during the time that the current is going through one complete period of alternation. To put it another way, the electromagnetic field 10 meters away from the antenna is caused by the current that *was* flowing in the antenna *one period earlier* in time; the field 20 meters away is caused by the current that *was* flowing *two periods earlier*, and so on.

Now if each period of current is simply a repetition of the one preceding it, the currents at

corresponding instants in each period will be identical, and the fields caused by those identical currents will also be identical. As the fields move outward they become more thinly spread over larger and larger surfaces, so their amplitudes decrease with distance from the antenna. But they do not lose their identity with respect to the instant of the period at which they were generated. That is, the phase of the outwardly moving surface remains constant. It follows, then, that at intervals of 10 meters (in the example above) measured outward from the antenna the phase of the waves at any given instant is identical.

In this fact we have the means for defining rather precisely both "wave front" and "wavelength." The wave front is simply a surface in every part of which the wave is in the same phase. The wavelength is simply the distance between two wave fronts having identical phase at any given instant. In the example, the wavelength is 10 meters because the distance between two wave fronts having the same phase is, as we found, 10 meters. This distance, incidentally, always must be measured perpendicular to the wave fronts; in other words, along the same line that represents the direction in which the wave is traveling. Measurements made along any other line between the two wave fronts would lead to the erroneous conclusion that the wave is longer than it really is. Expressed in a formula, the length of a wave is

$$\lambda = \frac{v}{f}$$

where  $\lambda$  = wavelength

$v$  = velocity of wave

$f$  = frequency of current causing the wave

The wavelength will be in the same length units as the velocity when the frequency is expressed in the same *time* units as the velocity. For waves traveling in free space (and nearly enough for waves traveling through air) the wavelength is

$$\lambda \text{ (meters)} = \frac{300}{f \text{ (MHz)}}$$

We shall continually be encountering this idea of phase in succeeding chapters in this book, because it is fundamental to the operation of antenna systems. It is essential, therefore, to have a clear understanding of what it means if antenna behavior is to be appreciated. Basically, "phase" means "time," but when something goes through periodic variations with time in the way that an alternating current does, corresponding instants in succeeding periods are said to have the same phase even though the actual time difference is the duration of one period. In using the word *phase* in this fashion we are inherently using the period as the unit of time measurement. Four o'clock yesterday afternoon corresponds to four o'clock this afternoon in much the same way that an instant in an ac cycle corresponds to the identical instant in the preceding period.



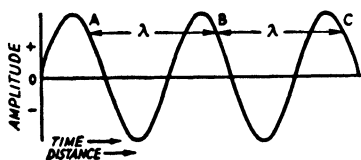

Fig. 1-2 — The instantaneous amplitude of both fields (electric and magnetic) varies sinusoidally with time as shown in this graph. Since the fields travel at constant velocity, the graph also represents the instantaneous distribution of field intensity along the wave path. The distance between two points of equal phase, such as *A-B* and *B-C*, is the length of the wave.

In Fig. 1-2 points *A*, *B* and *C* are all in the same phase because they are corresponding instants in the same period. This is a conventional drawing of a sine-wave alternating current with time progressing to the right. It also represents an instantaneous "snapshot" of the distribution of intensity of the traveling fields if distance is substituted for time in the horizontal axis. In that case the distance between *A* and *B* or between *B* and *C* represents one wavelength. This shows that the field-intensity distribution follows the sine curve, both as to amplitude and polarity, to correspond exactly to the time variations in the current that produced the fields. It must be remembered that this is an *instantaneous* picture; the actual wave travels along just as a wave in water does. To an observer at any fixed point along the wave path, the field intensity goes through *time* variations corresponding to the time variations of the current that initiated the wave.

### Field Intensity

The strength of a wave is measured in terms of the voltage between two points lying on an electric line of force in the plane of the wave front. The unit of length is the meter, and since the voltage in a wave usually is quite low, the measurement is made in microvolts per meter. The voltage so measured goes through time variations just like those of the original current that caused the wave, and so is measured like any other ac voltage — that is, in terms of the effective value or, sometimes, the peak value.

There are few, if any, occasions in amateur work where a measurement of actual field strength is necessary. This is fortunate, because the equipment required is elaborate. It is comparatively easy, however, to make measurements of *relative* field strength, and thus determine whether an adjustment to the antenna system has resulted in an improvement or not.

### Polarization

A wave such as is shown in Fig. 1-1 is said to be polarized in the direction of the electric lines of force. In this drawing the polarization is vertical because the electric lines are perpendicular to the

earth. A wave "with its feet on the ground" as in Fig. 1-1 is, as a matter of fact, usually vertically polarized. This is because the ground acts as a rather good conductor, particularly at frequencies below about 10 MHz, and it is one of the laws of electromagnetic action that electric lines touching the surface of a good conductor must do so perpendicularly. Over partially conducting ground there may be a forward tilt to the wave front; this tilt in the electric lines is greater as the energy loss in the ground becomes greater.

Waves traveling in contact with the surface of the earth are of little usefulness in amateur communication because as the frequency is raised the distance over which such a "surface" wave will travel without excessive loss of energy or attenuation becomes smaller and smaller. The surface wave is of most utility at low frequencies and through the standard broadcast band. At high frequencies the wave reaching the receiving antenna ordinarily has not had much contact with the earth and its polarization is not necessarily vertical. If the electric lines of force are horizontal, the wave is said to be horizontally polarized. However, the polarization can be anything between horizontal and vertical. In many cases, the polarization is not fixed but continually rotates. When this occurs the wave is said to be elliptically polarized.

### Attenuation

In free space the field intensity of the wave decreases directly with the distance from the source. That is, if the field strength one mile from the source has a value, let us say, of 100 microvolts per meter, the field strength at two miles will be 50 microvolts per meter, at 100 miles will be 1 microvolt per meter, and so on. This decrease in field strength is caused by the fact that the energy in the wave has to spread out over larger and larger spheres as the distance from the source is increased.

In actual communication by radio the attenuation of the wave may be much greater than this "inverse-distance" law would indicate. For one thing, the wave is not traveling in empty space. For another, the receiving antenna seldom is situated so that there is a clear "line of sight" between it and the transmitting antenna. Since the earth is spherical and the waves do not penetrate its surface to any considerable extent, communication has to be by some means that will bend the waves around the curvature of the earth. These means exist, but they usually involve additional energy losses that increase the attenuation of the wave with distance.

### Reflection, Refraction and Diffraction

It has been mentioned that radio waves and light waves are the same type of wave; the only difference is in the scale of wavelength. We are all familiar with the reflection of light; radio waves are reflected in much the same way. Frequently, however, the reflecting surfaces are small (in terms of wavelength) compared with the surfaces from which we see light waves reflected. An object the size of an automobile, for instance, will not reflect

much of the energy in an 30-meter wave. On the other hand, it may be a very good reflector of waves only a meter or two in length. The thickness of the object is of some importance because the waves penetrate it to an extent depending on its characteristics. In a material of given conductivity, for example, longer waves will penetrate farther than shorter ones and so require a greater thickness for good reflection. Thin metal is a good reflector even at quite long wavelengths, but in poorer conductors such as the earth — which certainly meets the requirement of having a surface that is large compared with any radio wavelength — the longer wavelengths may penetrate quite a few feet.

Reflection may also take place from any surface that represents a change in the dielectric constant of the medium in which the wave is moving. A familiar example in optics is the reflection of light from the surface of a pane of glass that is itself quite transparent to light waves. When viewed from certain angles, it is practically impossible to see through the pane of glass because of the reflected light.

Another phenomenon that has a rather familiar counterpart in optics is refraction, or the bending that takes place when the wave enters (at an angle) a medium having a different dielectric constant than the medium it has just left. This bending is caused by the fact that the wave travels at a different speed when the dielectric constant is changed. The part of the wave that enters the new medium first is either slowed down or speeded up, depending on the relative dielectric constants, and so tends to get ahead of or fall behind the sections of the wave that enter later. The effect is to change the direction in which the wave is moving. The classic example in optics is the apparent sharp bend in a stick held partly in and partly out of a body of water at an angle.

Most of the optical examples of refraction are based on two homogeneous substances having a very definite common boundary, as between air and glass. In that case the rays travel in straight lines *inside* either medium and the bending takes place at the common surface. In radio transmission it is frequently the case that the boundary between the two areas of differing dielectric constant is not at all sharp; the dielectric constant simply changes gradually over quite a distance along the wave path. This causes the wave bending also to be gradual, and the wave path becomes curved.

A somewhat less familiar optical phenomenon that has its radio counterpart is diffraction. To the eye, the shadows cast by a pin-point source of light appear to be quite sharp. However, close examination shows that light bends around the edge of an object to some extent, depending on the thickness of the edge. This effect becomes greater as the wavelength is increased, and can be of some importance at radio frequencies. For example, with waves traveling in a straight line one would expect that no signal could be heard behind a hill, but the bending caused by diffraction does produce a signal in the "shadow area." At high radio frequencies the diffracted signal is weak compared with the direct ray, and frequently is masked by stronger signals reaching the same spot by other means such as reflection or refraction in the atmosphere.

Both reflection and refraction can take place in various parts of the atmosphere, and the mechanisms by which they occur are likewise varied. The result is that radio waves frequently are "scattered," just as light is scattered in the atmosphere. Such scattering accounts for the reception of signals under conditions when they would not be expected from the simplified pictures of wave travel now to be discussed.

## THE GROUND WAVE

Waves travel close to the earth in several different ways, some of which involve relatively little contact with the ground itself. The selection of proper nomenclature therefore becomes somewhat confusing, but more or less by common consent the term **ground wave** is applied to waves that stay close to the earth and do not reach the receiving point by reflection or refraction from the much higher region of the atmosphere known as the ionosphere. The ground wave therefore can be a wave traveling in actual contact with the ground, such as the wave pictured in Fig. 1-1; or it can be a wave that goes directly from the transmitting antenna to the receiving antenna when the two antennas are high enough so that they can "see" each other. It can also be a wave that is refracted or reflected in the atmosphere near the earth (the troposphere).

## THE SURFACE WAVE

A wave that travels in contact with the earth's surface is called a surface wave. It is the type of

wave that provides reception up to distances of 160 kilometers or more in the standard broadcast band during the daytime. The attenuation of this

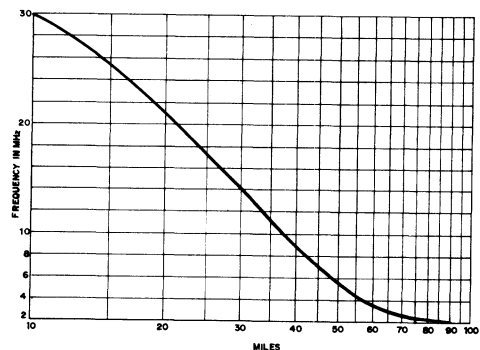

Fig. 1-3 — Typical hf ground-wave range as a function of frequency.

type of wave is rather high, so the intensity dies off rapidly with distance from the transmitter. The attenuation also increases rapidly with frequency, with the result that the surface wave is of little value in amateur communications, with the possible exception of the 1.8- and 3.5-MHz bands. Fig. 1-3 shows typical ground-wave coverage as a function of frequency throughout the hf spectrum. As explained earlier, the surface wave must be essentially vertically polarized. The transmitting and receiving antennas therefore must generate and receive vertically polarized waves, if the surface wave is to be utilized to advantage. In general terms, this means that both antennas must be vertical.

## THE SPACE WAVE

The conditions that exist when the transmitting antenna and receiving antenna are within line of sight of each other are shown in Fig. 1-4. One ray travels directly from the transmitter to the receiver and consequently is attenuated in about the same way as a wave in free space. However, the wave from the transmitting antenna also strikes the ground between the two antennas, and the ray that does so at the proper angle to reach the receiving antenna (the angle of incidence being equal to the angle of reflection, as in optics) combines with the direct ray to produce the actual signal at the receiving antenna.

In most practical cases where the communication is between two stations on the ground (as contrasted with communication between the ground and an airplane, or between two airplanes) the angle at which the ground-reflected ray strikes the earth and is reflected will be very small. That is, the ray strikes the earth at almost grazing incidence. Now it happens that such a reflection reverses the phase of the wave, so if the distance traveled by the direct wave and the distance traveled by the ground-reflected ray were exactly the same, the two rays would arrive out of phase and would cancel each other. Actually, the ground-reflected ray has to travel a little farther, and so the phase difference between the two rays depends on the difference in path length as measured in terms of wavelength. If the difference in the length of the two paths is 3 meters, for example, the phase difference from this cause will be only 3 degrees if the wave is 360 meters long. This is only a negligible shift in phase from the 180 degrees caused by the reflection, and so the signal strength would be small. On the other hand, if the wavelength is 6 meters, the phase shift caused by the same difference in path length would be 180 degrees — enough to overcome completely the 180-degree reversal caused by the reflection, so the two rays would add at the receiving antenna. In short, the space wave is a negligible factor in communication at low frequencies, because the difference in the distance traveled by the two rays is always very small, when measured in terms of wavelength. The space wave therefore is canceled out at such frequencies. But as the frequency is raised (wavelength shortened) the space wave

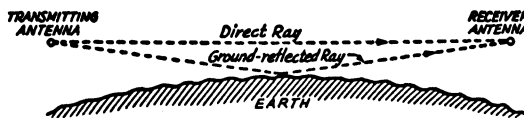

Fig. 1-4 — The ray traveling directly from the transmitting antenna to the receiving antenna combines with a ray reflected from the ground to form the space wave.

becomes increasingly important. It is the dominating factor in ground-wave communication at vhf and uhf.

The space-wave picture presented is a simplified one and, as usual, there are practical complications that modify it. There is some loss of energy when the ray strikes the ground, so the reflected ray does not arrive at the receiving antenna with the same intensity as the direct ray. Because of the ground loss the phase of the reflected ray is not shifted exactly 180 degrees. For both these reasons the two waves never cancel completely at the receiving antenna. Also, at frequencies in the uhf region it is possible to form the wave into a beam, much like the light beam from a flashlight. Such a beam puts most of the energy into the direct ray and reduces the amount that can strike the ground, particularly when the transmitting and receiving antennas are both at high elevations. Thus the effect of the ground-reflected ray is minimized.

Strictly speaking, the description above applies only to a horizontally polarized wave and perfectly conducting earth. Practically, the polarization does not make much difference because the earth is neither a perfect conductor nor a perfect dielectric. The overall result is that at frequencies below, say, 20 MHz, the space wave is inconsequential. But at vhf it is readily possible to transmit to the horizon by means of the space wave.

### “Line-of-Sight” Propagation

From inspection of Fig. 1-4 it appears that use of the space wave for communication between two points depends on having a line of sight between the two locations. This is not quite literally true. The structure of the atmosphere near the earth is such that under “normal” conditions (a theoretical normal, rather than an actual one; in many parts of the world, at least, the “normal” is an average which is statistically useful but seldom represents the actual condition of the atmosphere) the waves are bent into a curved path that keeps them nearer to the earth than true straight-line travel would. This effect can be approximated by assuming that the waves travel in straight lines but that the earth’s radius is increased in dimension by one third. On this assumption, the distance from the transmitting antenna to the horizon is given by the following formula:

$$D \text{ (mi)} = 1.415\sqrt{H \text{ (ft)}}$$

OR

$$D \text{ (km)} = 4.124\sqrt{H \text{ (m)}}$$

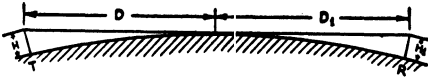

Fig. 1-5 — The distance,  $D$ , to the horizon from an antenna of height  $H$  is given by the formulas in the text. The maximum line-of-sight distance between two elevated antennas is equal to the sum of their distances to the horizon, as indicated in the drawing.

where  $H$  is the height of the transmitting antenna, as shown in Fig. 1-5. The formula assumes that the earth is perfectly smooth cut to the horizon; of course, any obstructions that rise along any given path must be taken into consideration. The point at the horizon is assumed to be on the ground. If the receiving antenna also is elevated, The maximum line-of-sight distance between the two antennas is equal to  $D + D_1$ ; that is, the sum of the distance to the horizon from the transmitting antenna and the distance to the horizon from the receiving antenna. The distances are given in graph form in Fig. 1-6. Two stations on a flat plain, one having an antenna on a tower 60 feet high and the other having an antenna supported 40 feet in the air, could be separated approximately 20 miles for line-of-sight communication.

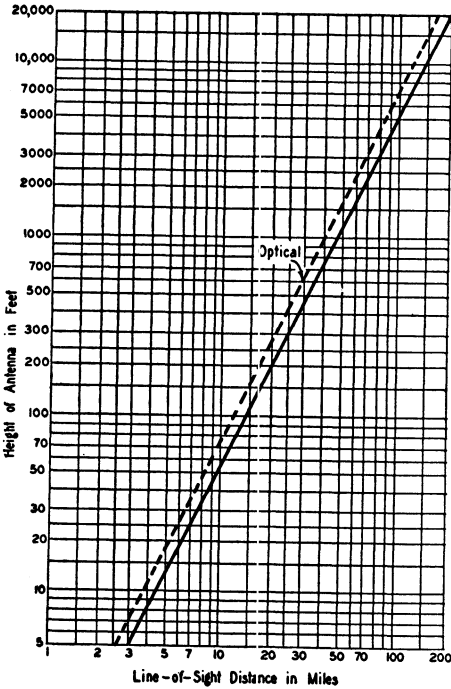

Fig. 1-6 — Distance to the horizon from an antenna of given height. The solid curve includes the effect of atmospheric refraction. The optical line-of-sight distance is given by the broken curve.

In addition to the “normal” refraction or bending, the waves also are diffracted around the curvature of the earth, so that the actual distance that can be covered does exceed the line-of-sight distance. However, under ordinary conditions the amount of diffraction at vhf and uhf where the space wave is of chief importance is rather small, and the signal strength drops off very rapidly in a short distance beyond the earth’s “shadow.”

To make maximum use of the ordinary space wave discussed here it is necessary that the antenna be as high as possible above the surrounding country. A hill that juts above the adjacent terrain is usually an excellent location. However, the peak of a hill is not necessarily the best spot, particularly if it is of the nature of a plateau. Arriving waves may have to be diffracted over the brow of the hill to reach the antenna unless the latter is placed on a high pole or tower; in other words, the brow of the hill may shield the antenna from waves arriving from a desired direction. Also, it is advantageous to have the ground drop off fairly sharply in front of the antenna, as this frequently prevents the ground-reflected ray from approaching at such a flat angle as it would over level ground. Generally speaking, a location just below the peak of a hill is the optimum one for transmitting and receiving in a desired direction, as indicated in Fig. 1-7.

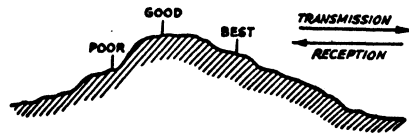

Fig. 1-7 — Propagation conditions are generally best when the antenna is located slightly below the top of a hill on the side that faces the distant station. Communication is poor when there is a sharp rise immediately in front of the antenna in the direction of communication.

Since the space wave goes essentially in a straight line from the transmitter to the receiver, the antenna used for radiating it should concentrate the energy toward the horizon. That is, the antenna should be a “low-angle” radiator, because energy radiated at angles *above* the horizon obviously will pass over the receiving antenna. Similarly, the receiving antenna should be most responsive to waves that arrive horizontally.

In general, the polarization of a space wave remains constant during its travels. Therefore, the receiving antenna should be designed to give maximum response to the polarization set up at the transmitting antenna. For vhf work both horizontal and vertical polarization are used, the former being more generally preferred. The principal reason for this preference is that the chief source of radio noise at vhf — that generated by the spark in the ignition systems of automobiles — is predominantly vertically polarized. Thus horizontally polarized antennas tend to discriminate against such noise and thereby improve the signal-to-noise ratio.

## PROPAGATION IN THE TROPOSPHERE

Weather conditions in the atmosphere at heights from a few thousand feet to a mile or two at times are responsible for bending waves downward. This tropospheric refraction makes communication possible over far greater distances than can be covered with the ordinary space wave. The amount of the bending increases with frequency, so tropospheric communication improves as the frequency is raised. The bending is relatively inconsequential at frequencies below 28 MHz, but provides interesting communication possibilities at 50 MHz and above.

Refraction in the troposphere takes place when masses of air become stratified into regions having differing dielectric constants. If the boundary between the two masses of air is sharply defined, reflection as well as refraction may take place for waves striking the boundary at grazing angles. The most common cause of tropospheric refraction is the temperature inversion. Normally, the temperature of the lower atmosphere decreases at a constant rate of approximately 3°F per 1000 feet of height. When this rate is decreased for any reason, a temperature inversion is said to exist and greater-than-normal wave bending takes place. Some of the types of temperature inversion are the *dynamic* inversion, resulting when a warm air mass overruns a colder mass; the *subsidence* inversion, caused by the sinking of an air mass heated by compression; the *nocturnal* inversion, brought about by the rapid cooling of surface air after sunset; and the *cloud-layer* inversion, caused by the heating of air above a cloud layer by reflection of the sun's rays from the upper surface of the clouds. Sharp transitions in the water-vapor content of the atmosphere may also bring about refraction and reflection of vhf waves.

Because the atmospheric conditions that produce tropospheric refraction are seldom stable over any considerable period of time, the strength of the received signal usually varies or "fades" over a wide range. Hourly and seasonal variations are observed. Best conditions often occur in the evening and just before sunrise, and conditions are generally poorest at midday when the atmosphere is relatively stable. Tropospheric refraction is generally greatest in the early summer and early fall. It is also more pronounced along the seacoasts.

The tropospheric wave maintains essentially the same polarization throughout its travel, so the transmitting and receiving antennas should have the same type of polarization. Since waves that enter the refracting region at anything other than practically grazing incidence are not bent enough to be useful for communication, the transmitting antenna should be designed for maximum radiation horizontally. The receiving antenna likewise should be a low-angle affair if the received signal is to be most efficiently utilized.

### Atmospheric Ducts

In some parts of the world, particularly in the tropics and over large bodies of water, temperature

inversions are present practically continuously at heights of the order of a few hundred feet or less. The boundary of the inversion is usually well enough defined so that waves traveling horizontally are "trapped" by the refracting layer of air and continually bent back toward the earth. The air layer and the earth form the upper and lower walls of a "duct" in which waves are guided in much the same fashion as in a metallic wave guide. The waves therefore follow the curvature of the earth for distances far beyond the optical horizon of the transmitter (sometimes for hundreds of miles).

Because the height of an atmospheric duct is relatively small, only waves smaller than a certain limit will be trapped. If the refracting layer is only a few feet above the surface the lowest usable frequency may be as high as a few thousand megahertz, so ultrahigh or superhigh frequencies must be used. Under some conditions, however, the height and dielectric characteristics of the layer may be such that waves in the medium vhf region will be transmitted. The line of distinction, if any, between ducting and ordinary tropospheric propagation is hard to draw in such a case.

A feature of duct transmission is that the antennas, both transmitting and receiving, must be *inside* the duct if communication is to be established. If the duct extends only a few feet above the earth and the transmitting antenna is on a tower or promontory *above* the duct, no signals will be heard at the receiving point. Likewise, a receiving antenna situated above the duct will not pick up energy trapped nearer the earth.

Atmospheric ducts also are formed between two layers of air having suitable characteristics. If the lower layer refracts the waves *upward* while the upper layer refracts them *downward*, waves will be trapped between the two layers and again can travel for great distances. In such a case antennas either below or above the duct will be ineffective. Ducts of this type have been observed from airplanes, where good signals will be received with the plane at the optimum height but the signal strength drops off rapidly at either higher or lower altitudes.

Much remains to be learned about the extent of duct transmission at amateur frequencies. There appears to be no significant difference in the signal strength with either horizontal or vertical polarization.

### Other Modes

Although the transmission modes just discussed are the most common ones at vhf, they are by no means the only methods by which communication can be carried on at such frequencies. New modes are continually being discovered as better antennas and equipment are developed. However, it is invariably true that best results in all types of vhf propagation are obtained when the transmitting antenna system concentrates as much as possible of its energy in the very low vertical angles, and when the receiving antenna likewise is most responsive to signals arriving horizontally.

## THE SKY WAVE

At frequencies below 30 MHz practically all amateur communication except for local work over distances of a few miles (see Fig. 1-3) is carried on by means of the sky wave. This is the wave that, on leaving the transmitting antenna, would travel on out into empty space if it were not for the fact that under certain conditions it can be sufficiently reflected or refracted, high up in the earth's atmosphere, to reach the earth again at distances varying from zero to about 4000 kilometers (2500 miles) from the transmitter. By successive reflections at the earth's surface and in the upper atmosphere, communication can be established over distances of thousands and thousands of miles. On occasion, radio signals have been known to travel completely around the earth.

### THE IONOSPHERE

The region of the earth's upper atmosphere in which the radio waves are bent back to the earth's surface is called the ionosphere. This is an area where the air pressure is so low that "free" electrons and ions can move for a long time without getting close enough to each other to be attracted together and thus recombine into a neutral atom. The ionosphere is sometimes referred to as the rarefied atmosphere.

A radio wave entering a region in which there are many free electrons will be affected in much the same way as one entering a region of differing dielectric constant; that is, its direction of travel will be altered. A simple explanation of the rather complex mechanism involved is given earlier in this chapter under the subheading of *Reflection, Refraction and Diffraction*.

Ultraviolet radiation from the sun is the primary cause of ionization in the upper atmosphere. The amount of ionization does not change uniformly with height above the earth, as might be expected at first thought. Instead, it is found that there are relatively dense regions (or layers) of ionization, quite thick vertically, at rather well-defined heights. However, the interregional troughs, as verified through rocket soundings during the International Geophysical Year (IGY), 1958, are more shallow than had been thought for many years. The ionization level is not uniform within a specific region, but rather tapers off gradually above and below the peak ionization level at the center of the region. Because the amount of ultraviolet and other types of radiation received from the sun at any given time over any given point above the earth's surface will vary, the height and ionization intensity of the various regions will likewise vary. The condition, then, of the ionosphere over any given point will vary with the time of day (the received radiation from the sun is maximum at solar noon), the season of the year (because of the tilt of the earth's axis and the varying seasonal distance between earth and sun), and the so-called 11-year sunspot cycle (refer to later section on *Ionosphere Variations*).

### Layer Characteristics

The ionized layers or regions are designated by letters. The lowest ionized layer known, at a height of about 60 to 92 kilometers (37-57 miles), is called the *D* region. Because it is in a relatively dense part of the atmosphere the atoms broken up into ions by sunlight quickly recombine, so the amount of ionization depends directly on the amount of sunlight. Thus *D*-region ionization is maximum at local noon and disappears at sundown. When electrons in the *D* region are set into motion by a passing wave, the collisions between particles are so frequent (because of the rather high air density) that a substantial proportion of the wave energy may be used up as heat. The probability of collisions depends on the distance an electron can travel under the influence of the wave. This distance depends on the frequency of the wave, because during a long cycle (low frequency) the electron has time to move farther, before the direction of the field reverses and sends it back again, than it does in a short cycle (high frequency). If the frequency is low enough the collisions between particles will be so frequent that practically all energy in the wave will be absorbed in the *D* region. This usually happens at frequencies in the 3.5-4.0 MHz amateur band at the time of maximum *D*-region ionization, particularly for waves that enter the layer at the lower vertical angles and thus have to travel a relatively long distance through it. At times of sunspot maxima even waves entering the layer directly upward will be almost wholly absorbed, in this frequency band, around the middle of the day. The absorption is less in the 7-MHz band and is quite small at 14 MHz and higher frequencies. The *D* region is relatively ineffective in bending high-frequency waves back to earth, and so plays no significant part in amateur long-distance communication except as an absorber of energy. It is the principal reason why daytime communication on the lower frequencies (3.5 and 7 MHz) is confined to relatively short distances.

The lowest layer that affords long-distance communication is in the *E* region, which appears 100 to 115 kilometers (62-71 miles) above the earth. It is a region of fairly high atmospheric density and consequently the ionization varies with the height of the sun (angle above the horizon). Ultraviolet radiation is not alone in affecting the ionization of this region. A certain amount of ionization is also caused by solar photons, X rays, and meteoric activity within the region. The ionization level drops rapidly after sundown, when ions and electrons recombine in the absence of sunlight, and reaches a minimum level of ionization after midnight local time. It again increases rapidly at sunrise and reaches a maximum at about noon local time. As in the case of the *D* region, the *E* region (or layer) absorbs energy from low-frequency waves during the time of maximum ionization.

Fig. 1-8 — Behavior of waves on encountering the ionosphere. Waves entering the ionized region at angles higher than the critical angle are not bent enough to be returned to earth. Waves entering at angles below the critical angle reach the earth at increasingly greater distances as the angle approaches the horizontal.

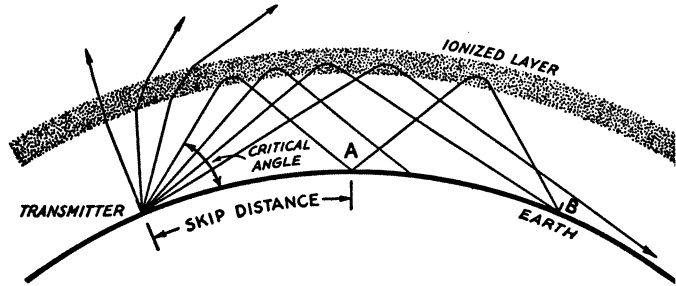

Most long-distance communications result from ionization which takes place in the  $F$  region. Its principal area is the  $F_2$  layer which varies considerably in ionization level and in height. It may be anywhere from 210 to 420 kilometers (130-261 miles) above the earth, depending on season, latitude, time of day, and the portion of the sunspot cycle prevalent at a given time. At these heights the atmosphere is very thin, and so the ions and electrons are slow to recombine. Because of this, the level of ionization is not so responsive to the height of the sun; it reaches a maximum shortly after noon local time, but tapers off quite gradually thereafter. The amount of ionization continues to remain at a fairly high level throughout the night, reaching a minimum just before sunrise. At sunrise it increases rapidly and attains the daytime level in the course of an hour or two.

During the day the  $F$  region sometimes splits into two layers. The lower and weaker one, occurring at a height of 160 kilometers (99 miles), is designated the  $F_1$  layer. This layer plays only a minor role in long-distance communications, acting more like the  $E$  than the  $F_2$  layer in terms of daily life cycle and communications effectiveness. At night the  $F_1$  layer disappears and the  $F_2$  layer height drops somewhat.

#### Refraction in the Ionosphere

The amount by which the path of a wave is bent in an ionized layer depends on the intensity of ionization and the wavelength. The greater the ionization, the more the bending at any given frequency. Or, to put it another way, for a given degree of ionization the bending will be greater as the frequency of the wave is lowered — in other words, as its wavelength is increased.

Two extremes thus become possible. If the ionization is intense enough and the frequency is low enough, a wave entering the ionized region *perpendicularly* will be turned back to earth. But as the frequency is raised or the ionization is decreased, a condition will eventually be reached where the bending will not be sufficient to return the wave to earth, even though the wave leaves the transmitting antenna at the lowest possible angle and thus requires the least bending in the ionosphere. A typical "in-between" condition is illustrated in Fig. 1-8, a simplified illustration of the paths taken by high-frequency waves and considering only the effect of a single layer.

Fig. 1-8 shows a condition that is frequently typical of the way waves are bent in a single layer. (When several layers are involved, the paths are naturally more complex, since the layers have differing characteristics.) In this case the layer is capable of refracting waves that enter it at low angles. However, as the angle at which the ray strikes the layer is increased, a **critical angle** is reached at which the ray just manages to be bent back to earth. Rays entering at still greater angles are not bent enough and pass through the layer into empty space. Since such rays are useless for communication, it is obvious that energy radiated at angles above the critical angle is wasted.

Note also that the point at which a ray reaches the earth on its return journey from the ionosphere depends on the angle at which it left the transmitting antenna. The larger the angle with the surface of the earth the shorter the distance from the transmitter to the point at which the returning ray arrives.

#### Skip Distance

When the critical angle is less than 90 degrees the highest angle wave that can be bent back to earth will return at an appreciable distance from the transmitter. For some distance, then, depending on the critical angle, there is a region about the transmitter where the sky-wave signal will not be heard. This "silent" region, extending from the limit of the useful ground wave to the distant point where the sky-wave signal can first be heard, is called the skip zone, because all signals skip over it. The skip zone is indicated by the skip distance in Fig. 1-8.

The skip distance — the distance from the transmitter to the point where the sky-wave signal is first heard — depends on the critical angle and the layer height. The lower the critical angle the farther the skip distance extends. Since higher frequencies are, in general, bent less than lower frequencies, the skip distance is greater the higher the frequency. For a given critical angle, it is also greater the greater the height of the layer in which the bending takes place. Thus for the same critical angle, the skip distance with  $F_2$ -layer bending will be greater than for waves returned to earth from the  $E$  layer, because the  $F_2$  layer is higher.

When waves at any and all angles are returned to earth from the layer, there is, of course, no skip zone. In such instances the sky wave frequently is

stronger than the ground wave, even as close as a few miles from the transmitter location. This is because the wave is attenuated less in its travel up to the layer and back again than it is in going a few miles over the ground, surprising as it may seem.

### Single- and Multihop Propagation

Fig. 1-8 also shows two of the modes by which the signal can reach a distant receiving point. In one case the wave is bent in the layer at a point about midway between the transmitter and the receiving point, *B*. The wave thus makes the trip in one "hop." However, that is not the only possibility. A ray that is reflected midway between the transmitter and point *A* (which in turn is midway between the transmitter and *B*) will be reflected when it strikes the earth at *A* and will go up to the layer again. Here it is once more reflected, returning to earth, finally, at *B*. This is "two-hop" transmission. More than two hops are readily possible.

Multihop propagation over long distances tends to become more complex than the simple geometrical picture given here would indicate, partly because different ionospheric conditions usually exist at each point of reflection. Observation indicates, however, that the hops are well defined over distances up to several thousand miles, and antennas for commercial point-to-point circuits usually are designed to radiate and receive best at the vertical angles associated with the number of hops between the transmitting and receiving points. The smallest possible number of hops is best, in general, since each additional hop introduces additional attenuation because of losses at the reflection points. Even more important, however, is the effect of the ionosphere itself as described later. Ionospheric absorption may be so much less, at a given operating frequency, with say three or four hops instead of two over a given path that the received signal will be much stronger in spite of the additional reflection loss.

### Virtual Height and Critical Frequencies

By using a frequency low enough so that waves entering the ionosphere at the maximum angle of 90 degrees (i.e., waves going vertically from the transmitting antenna to the ionosphere) are returned to earth, it is possible to measure the height of the ionosphere. This is done by measuring the time taken by the wave to go up and back. Knowing the time and velocity of propagation, the distance can be readily calculated. The distance so found is the **virtual height**, or the height from which a pure reflection would give the same effect as the refraction that actually takes place. The method is illustrated in Fig. 1-9. Because a certain amount of time is required for the wave to make the turn at the top of its travel, the virtual height is somewhat higher than the actual height, as the illustration shows.

If the transmitting frequency is gradually increased while height measurements of this type are being made, eventually a frequency range will be encountered where the virtual height seems to increase rapidly, until finally the wave does not

come back. The highest frequency that is returned to earth is known as the **critical frequency**. As the frequency is further increased beyond the critical frequency, the wave must enter the ionosphere at progressively smaller angles in order for it to be bent back to earth. By using very low angles, long-distance transmission via the  $F_2$  layer is possible at frequencies up to about 3.5 times the critical frequency. Thus, the critical frequency is a measure of the reflecting ability of the ionosphere.

Since the refracted wave acts as though it were reflected from a mirror at the virtual height, it is customary to use the terms "reflection" and "refraction" almost interchangeably in connection with ionospheric propagation. In most cases the actual process is refraction. However, it is possible for true reflection to occur if the boundary of the layer is sharply defined and the wave strikes it at a small enough angle.

Virtual heights, of course, depend on the height of the ionized region. The critical frequencies vary with the intensity of ionization in the layers, being greater when the ionization increases. Since the ionization is greatest at the peak of the sunspot cycle, critical frequencies are highest in both the  $E$  and  $F_2$  layers during that period. Conversely, they are lowest during a sunspot minimum. The  $E$ -layer critical frequency ranges from about 1 to 4 megahertz depending on the period in the sunspot cycle and the time of day. The  $F_2$  critical frequency varies with the time of day, the season, and the sunspot cycle, ranging from a low of perhaps 2 to 3 MHz at night in a sunspot minimum to a high of 12 or 13 MHz in daytime during a sunspot maximum. Whenever the critical frequency is above an amateur band, it is possible to communicate on that band over all distances from zero to the maximum that absorption will permit.

### Maximum Usable Frequency

Of more interest, from a practical standpoint, than the critical frequency is the frequency *range* over which communication can be carried on via one or the other of the two reflecting layers. In particular, it is useful to know the **maximum usable frequency** (abbreviated *muf*) for a particular

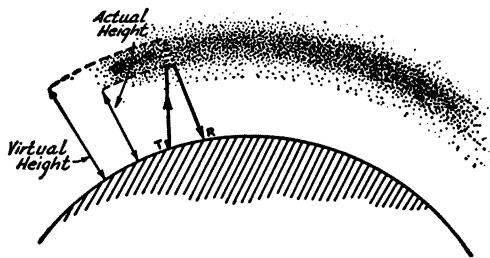

Fig. 1-9 — The "virtual" height of the refracting layer is measured by sending a wave vertically to the layer and measuring the time it takes for it to come back to the receiver. The actual height is somewhat less because of the time required for the wave to "turn around" in the ionized region.



distance at the time of day at which communication is desired. It is always advantageous to use the highest possible frequency because the absorption is less the higher the frequency. Therefore the muf always gives the greatest signal strength at the receiving point for a given transmitting power. The distance to be considered in determining the muf is the length of one hop in multihop transmission.

The muf depends upon the critical frequency and thus is subject to seasonal variations as well as variations throughout the day. To employ the muf for very long distances with the smallest number of hops requires that the antenna system radiate well at very low vertical angles.

### Lowest Usable Frequency

As the frequency is decreased below the muf, the signal strength also decreases because of greater absorption. Eventually, as the frequency continues to be lowered, the signal will disappear in the background noise that is always present. Thus there is a low-frequency limit, under a given set of ionospheric conditions, as well as a high-frequency limit to the range of frequencies that can be used for a given distance. The lowest usable frequency (abbreviated luf) depends considerably on the transmitter power available, since high power will "push" the signal through the noise where low power would fail. But when the frequency in use is near the muf, even low-power signals often will give surprising signal strength at long distances.

In commercial communications it is considered good practice to operate on a frequency which is about 15 percent below the muf. This allows for day-to-day variations in the ionosphere. This somewhat lower frequency is known as the optimum working frequency, abbreviated owf. The international abbreviation, *fof*, is generally used, from the initial letters of the French words for optimum working frequency, "Frequence Optimum de Travail." Since amateur stations work in fixed bands of frequencies, it is not possible to choose either the muf or *fof* at will. Instead, the *time of day* at which optimum conditions can be expected for a given path and distance on a particular band must be determined.

### Transmission Distance and Layer Height

Consideration of Fig. 1-8 shows that the distance at which a particular ray returns to earth depends upon the angle at which it enters the layer. This angle in turn is determined by the angle (called the wave angle) at which the ray leaves the transmitting antenna. Not shown in the drawing, but inherent in the geometry of the situation, is the fact that the distance also depends on the layer height. As the layer height is increased, the distance at which a ray leaving at a fixed wave angle returns to earth also increases. The same wave angle, therefore, will result in transmission over a greater distance when the wave is reflected by the  $F_2$  layer than when it is reflected by the  $E$  layer.

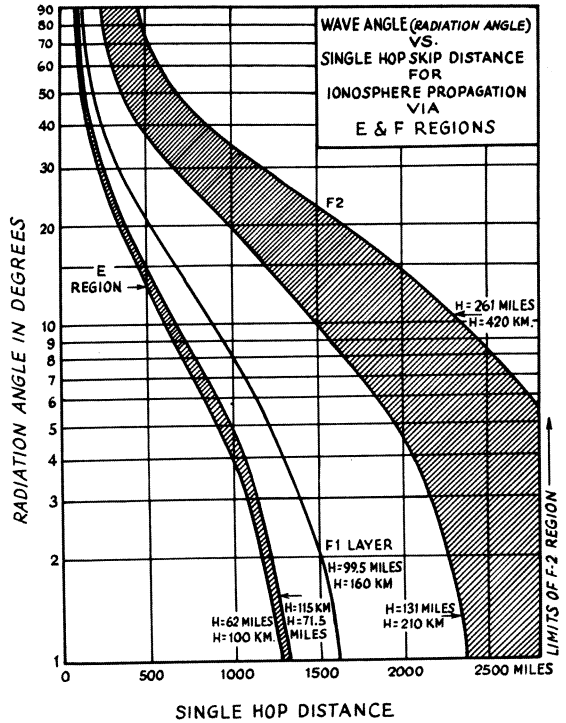

Fig. 1-10 — Distance plotted against wave angle (one-hop transmission) for the nominal range of virtual heights for the  $E$  and  $F_2$  layers, and for the  $F_1$  layer.

The maximum distance that can be covered by a single-hop transmission is approximately 2000 kilometers (1250 miles) when reflection is from the  $E$  layer, and approximately 4000 kilometers (2500 miles) when reflected from the  $F_2$  layer. These distances are based on average virtual heights (refer to Fig. 1-9), and in both cases a wave angle of zero is required. The actual distance covered by single-hop transmissions is usually somewhat less, at least at frequencies below about 28 MHz, because of ground losses at wave angles below about 3 degrees. The wave angle required for any single-hop distance may be determined by referring to Fig. 1-10 — the shaded areas represent the ranges of possible layer heights. Transmission paths in excess of 4000 kilometers (the maximum single-hop range) obviously require multiple hops. This will be discussed later in the chapter. One-hop transmission, when possible, will provide the greatest signal strength at the receiving point because there is some energy loss at each reflection, whether in the ionosphere or at the earth. At the longer distances, this requires a small wave angle, or "low-angle radiation" from the antenna. High-angle radiation is most useful for covering short distances. It will be appreciated that "long distance" and "short distance" are relative terms when it is remembered that the distance depends on the layer height as well as the wave angle. At times when the frequency in use is reflected by the

*E* layer the distance will be one thing, but at another time of day when the *E* layer is ineffective and the  $F_2$  layer comes into play the same wave angle from the same antenna will cover a much larger distance. That is one reason why it is possible to communicate over longer distances at night on frequencies in the vicinity of 7 MHz than it is in the daytime.

#### Long-Distance Transmission

From the discussion in the preceding section, it should be clear that transmission over distances greater than 4000 km (2500 miles) must involve multihop propagation, because 4000 km is the maximum distance that can be covered by one hop via the highest layer. Since multihop transmission increases the energy loss, it is quite important, for most effective long-distance transmission, that a frequency near the muf be used, and that the antenna concentrate the radiation at low angles so that the number of reflections will be small.

The propagation of waves over long paths is complicated by a number of factors. For example, at the particular frequency used the *E* layer may reflect the waves along part or parts of the path while the *F* layer does the reflecting at other parts. This will depend on the time of day, whether the path is generally north-south or east-west, the part of the world over which the path lies — in short, on the state of the ionosphere all along the path. It is also possible that a wave reflected downward from the  $F_2$  layer will be reflected *upward* from the *E* layer instead of being reflected from the earth. However, all these possibilities have but little effect on the primary consideration in DX-antenna design — that the antenna should concentrate the radiation at the lowest possible angle.

Despite the complexity of long-distance propagation, there is a method of determining average communications possibilities in advance. This is based on predictions of the muf at two "control points" in the ionosphere. For distances beyond 4000 km, the control points are located at 2000 km (1250 miles) from the transmitter and the receiver, respectively, along the great-circle path between them. For shorter distances, the two

control points are located one fourth of the path length from each terminal point. If the muf at the transmitter's control point is, say 14 MHz, ionospheric propagation in the direction of the receiver is possible on that frequency. If the muf at the receiver's control point is 14 MHz or higher, ionospheric propagation is possible over the complete path and the signal will be heard. On the other hand, if the muf at the receiving control point is only 10 MHz, a 14-MHz signal from the transmitter will not be heard. The transmitting frequency must then be lowered to 10 MHz before communications will be possible. In other words, the *lower* of the mufs at the two control points is the muf of the *circuit*. The muf values at control points in any part of the world can be determined in advance from charts described later in this chapter under the subheading of *Prediction Charts*. In theory, communication is possible at any frequency below the circuit muf, while in practice the absorption becomes too great if the frequency is lowered too much below the muf.

The *E* layer may be effective at the control point at either end of the circuit. This will be the case if the frequency to be used is below the *E*-layer muf at that particular time. This fact should not be forgotten, because frequently it happens that the  $F_2$  layer is controlling one end of the path and the *E* layer the other. It can also happen that the *E* layer controls both ends of the path. Under such circumstances the  $F_2$  muf may be so high at both ends of the circuit that high absorption would be expected, whereas the actual case is that rather good signals will be received because the operating frequency is near the *E*-layer muf at one or both ends.

The control-point method of prediction does not take into account *how* the waves travel from the transmitter to the receiver. Its justification is that it has been found to be a useful method, on the average, for predicting whether or not communication will be possible at a given frequency, or for selecting a frequency that will give communication between any two points.

The vertical angle at which a wave arrives at the receiving point in long-distance transmission has

Freq. MHz	TABLE 1-1		
	Angle below which signals arrived 99% of the time	Angle above which signals arrived 50% of the time	Angle above which signals arrived 99% of the time
7	35°	22°	10°
14	17°	11°	6°
21	12°	7°	4°
28	9°	5°	3°

Table 1-1 — Measured vertical angles of arrival of signals from England at receiving location in New Jersey.

Fig. 1-11 — Typical daytime propagation of high frequencies (14 to 28 MHz). The waves are partially bent in going through the  $E$  and  $F_1$  layers, but not enough to be returned to earth. The actual reflection is from the  $F_2$  layer.

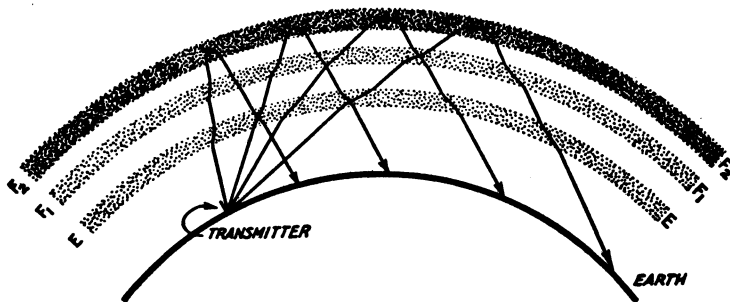

been found by measurement to vary over a considerable range. For example, measurements on a path from England to the New Jersey (U.S.A.) coast indicate that on 7 MHz the wave angle of the received signal at times is as high as  $35^\circ$  and on 14 MHz is at times as high as  $17^\circ$ . For 99 percent of the time it is below those figures on these two frequencies. On the other hand, the same measurements showed that for 99 percent of the time the angle was above  $10^\circ$  on 7 MHz and above  $6^\circ$  on 14 MHz. For about half the time the angle was between  $22^\circ$  and  $35^\circ$  on 7 MHz and between  $11^\circ$  and  $17^\circ$  on 14 MHz. Whether or not there is exact reciprocity between the transmitting and receiving wave angles, these figures clearly indicate the importance of keeping the wave angle low. They also show that the higher the frequency, the less useful the higher wave angles become in terms of transmission over long distances. The above mentioned information is presented in Table 1-I for easy reference.

#### Polarization and Direction of Travel

Because of the nature of refraction in the ionosphere, the polarization of the refracted wave usually is shifted from the direction it had on leaving the transmitting antenna. It is therefore not at all necessary to use antennas having the same polarization at the receiving and transmitting points. At the frequencies for which sky waves are useful, most amateurs use horizontal antennas. Depending on the type, such antennas may generate either horizontally or elliptically polarized waves.

For the most part, a wave follows the most direct path between the transmitter and receiver. In other words, it follows the great circle connecting the two points. Because of variations in the ionosphere, the actual path may vary slightly, and shifts of as much as 5 degrees from the true great-circle path occur at times.

There are always two great-circle paths connecting two points on the earth's surface, one representing the shortest distance between them and the other a path in exactly the opposite direction — around the world the other way. Most communication is via the "short path." However, "long-path" communication is not uncommon, particularly when there is not too much difference between the two distances. At certain times of the day, when the short path would be inoperative, the ionosphere may be able to support communication over the long path. Contacts in excess of 32,000

kilometers (20,000 mi.) via long path are not uncommon, particularly at sunrise and sunset local time.

Occasionally waves arrive from directions that seem to bear no visible relationship to the direction in which the transmitting station lies. While there are well-authenticated cases of this, and reasonable explanations have been worked out on the basis of known behavior of the ionosphere, it is probable that the apparent shift in direction frequently observed by amateurs is a result of "scattering," described in a later section. It is also possible that a combination of the vertical angle at which the wave arrives and minor responses of the antenna system being used gives a false direction indication. Accurate direction finding with the sky wave at high frequencies is extremely difficult, requiring highly specialized design and construction of equipment.

#### MISCELLANEOUS FEATURES OF SKY-WAVE PROPAGATION

Although not having any very direct bearing on antenna design, there are several aspects of sky-wave transmission that are of considerable interest from an operating standpoint. The ability to recognize and appraise unusual propagation effects often will help to explain seeming inconsistencies that may wrongly be blamed on faulty antenna design.

#### Ionosphere Variations

The daily and seasonal variations in the ionized layers that result from changes in the amount of ultraviolet light received from the sun have already been mentioned. Reference has also been made to the 11-year sunspot cycle, which directly affects propagation conditions because there is a rather direct correlation between sunspot activity and ionization. The 11-year figure for the time between successive peaks of sunspot activity is only an average; any given cycle may vary a few years either way. The peak in 1968 was of average stature, having a maximum smoothed sunspot number not much in excess of 110. By contrast, the peak which occurred in 1957-1958 had a smoothed number of sunspots exceeding 200 and was the highest ever recorded. On occasions the  $F_2$  muf rose well into the vhf portion of the spectrum. Daily sunspot counts are recorded, and monthly and yearly averages determined. The smoothed sunspot number (also called the 12-month running average) for a given month is the mean for the

preceding 6 months and the succeeding 6 months about the month in question. The sunspot number is not the actual number of spots observed, but rather a weighted figure which takes into account such factors as the number of *groups* of sunspots, the number of individual spots counted, and the equipment used to make the measurements. The result is known as the Wolf number,  $R$  (after the man who derived the system for standardizing the sunspot count), and has been in use since the mid-18th century. Because international records are kept in Zurich, Switzerland, Wolf numbers are also known as Zurich smoothed sunspot numbers.

The smoothed sunspot number (SSN) has been used extensively as an index of solar activity. Although it is not entirely satisfactory as a measure of this activity, it is the only index with a series of observations long enough for prediction purposes. Recently, it has been determined that the 10.7-cm solar radio noise flux ( $\phi$ ) is generally a more accurate measure of solar activity. However, the available series of observations is still too limited for present prediction techniques. Since the two indices are highly correlated, either index may be used.

At a sunspot minimum there is a period of a year or two when the  $F_2$  muf does not get as high as 28 MHz in the temperate latitudes. This mainly affects east-west communications. Transequatorial openings are not uncommon even with smoothed sunspot counts below 5.

A small, but regular, variation in sunspot activity occurs over a period of 27 or 28 days. This is the time required for the sun to make one rotation on its axis. The consequent rise and fall of the muf makes a noticeable change in propagation conditions at frequencies from 14 to 28 MHz.

### “One-Way” Skip

In long-distance hf communications via the ionosphere the relationship between receiving and transmitting capability over a given circuit may not be exactly reciprocal. Investigations of this phenomenon are, thus far, inconclusive. Several theories are currently popular. For whatever the reason or reasons, the propagated waves do not *always* take exactly the same paths from the two terminal points, and so show considerable variation in alternate transmission and reception.

This condition of “one-way” skip has been thought to exist for any or all of the following reasons; tilting of the ionosphere, different muf conditions at each end of the path, the presence of  $E$  layer at one end of the path and not the other, and higher  $D$ -region absorption at one end of the path than at the other. When “one-way” skip conditions occur, one end of the path is generally in the darkened hemisphere of the earth and the other in daylight.

### Fading

Variations in the strength of a received signal are classified under the general term, *fading*. Long-period variations are to be expected through the day, on any given frequency, because the

absorption changes with the height of the sun. There is also the daily variation of the muf; when the muf drops below the frequency in use, the signal will “fade out.”

In addition, the ionization at any part of the layer is in a continual state of change; there is turbulence in the ionosphere, just as there is some turbulence in the atmosphere even on quiet days when the weather seems stable. The amount of absorption is continually varying; waves entering the ionosphere at slightly different angles will be refracted differently; the polarization is continually changing with refraction. The wave reaching the receiving antenna is usually made up of a group of rays each of which has been acted on a little differently by the ionosphere. Sometimes the rays are more or less in phase when they strike the receiving antenna; at other times some of the rays may be out of phase with others. The result is a continual variation in signal strength that may occur at rates varying from several times a second to once every few minutes.

When transmission conditions are not alike for waves of slightly different frequency, the sidebands in voice transmission may have a different fading pattern than the carrier or than each other. This is known as selective fading. It causes severe distortion of the modulation, especially when the carrier of an a-m or fm signal fades down while the sidebands do not. The distortion is, in general, worse with frequency modulation than with amplitude modulation, and is least with single-sideband transmission. Selective fading is more serious at the lower frequencies, such as 4 MHz, where the sideband frequencies represent a larger percentage of the carrier frequency than they do at a frequency such as 28 MHz.

Fading may be entirely different at two receiving points only a short distance apart. By the use of antennas separated by a wavelength or two, feeding separate receivers, it is possible to overcome the effects of amplitude fading, but not of selective fading. Similar use of inputs from antennas of differing polarization will often serve the same purpose. Such receiving arrangements are known as “diversity” systems.

### Ionospheric Storms

Unusual eruptions on the sun cause disturbances in the ionosphere called ionospheric storms. These are accompanied by disturbances in the earth's magnetic field called magnetic storms. Storms of this type are most frequent during the sunspot cycle peak. They have a pronounced effect on radio communication. The most prominent features of these storms are the reduction in the  $F_2$  critical frequencies and the increase in  $D$  region absorption. The practical consequence of this lowering of the muf and raising of the luf is a narrowing of the usable frequency spectrum. On high frequencies, communication frequently becomes impossible, as though the refracting layers had disappeared. The storms vary in intensity and duration. They may last from one to several days.

Ionospheric storms tend to recur at approxi-

mately 28-day intervals since they are associated with particular sunspots or groups of sunspots, and these tend to maintain a more or less fixed position on the sun's surface as it rotates. The period of rotation, as mentioned before, is about 28 days.

### Aurora

During magnetic storms auroral activity becomes more pronounced and extends farther from the polar regions than is normally the case. During abnormal auroral activity a peculiar form of wave propagation is frequently observed, in which the auroral curtain acts as a reflector. Waves directed toward the polar regions will be reflected back and can be used for communication on frequencies and over distances that normally would be skipped over. When this condition prevails, it is necessary, when directive antennas are used, that both the transmitting and receiving antennas be directed toward the polar regions rather than along the great-circle path between the two stations. While most of the hf bands are rendered useless for long-distance communication because of the increased absorption and instability of the ionosphere, the higher frequencies, beginning with about 28 MHz, are enhanced for beyond-local communications. East-west paths of up to about 1300 miles are possible using this form of propagation. In the southern hemisphere one would beam southward, since the aurora is a geomagnetic polar phenomenon.

Characteristically, aurora imparts a rapid flutter to signals. This flutter, which is not constant, may be anywhere from 100 to 2000 Hz and makes cw the preferred mode for communications, as most phone signals (even ssb) are difficult to read unless signal levels are extremely high. The higher one goes in frequency to work via an auroral opening, the stronger phone signals must be in order to be readable.

Propagation via auroral-curtain reflection occurs more often near the poles than at midlatitudes. It is nonexistent in the tropics. The auroral display need not be visible at a given location in order to take advantage of its properties; auroral propagation may continue night and day for several days but the display would not be visible during the daylight hours in most latitudes. In December and January, auroral propagation is least likely. Its peaks occur in March and September, but it is apt to happen at any time.

### Sudden Ionospheric Disturbances

At times, without warning, sky-wave hf communication is severely disrupted by sudden ionospheric disturbances (SID). Solar flares, heavily laden with ultraviolet and X rays, affect the *D* region in such a manner as to render communications all but impossible. *D*-region absorption increases markedly, because of sharply increased ionization. High-frequency signals suddenly fade out and gradually return some minutes to some hours later, eventually reaching pre-SID levels.

Solar flares are frequently followed by ionospheric storms. These storms, which generally

begin some 18 to 36 hours after the occurrence of the solar flare, produce a variety of adverse effects in the ionosphere. For example, it sometimes causes the muf to drop as low as half its pre-storm value while at the same time the *h<sub>p</sub>f* rises greatly. The *F<sub>2</sub>* layer seems to disappear at times, or may appear to split into several layers — causing severe rapid fading and echoes. At this time, ionospheric propagation conditions are poor. Ionospheric storms may last from 2 to 5 or more days. During the peak of the sunspot cycle they are more intense, but are of shorter duration than during sunspot minimum periods. During the storms, only line-of-sight and ground-wave communications remain reliable.

### Scatter Signals

When a skip zone exists it might be expected, from the simplified explanations of propagation given earlier, that no signals at all would be heard from stations too near to be reached by the sky wave and too far away for the ground wave to be heard. Actually, however, signals from these stations usually can be detected. The strength is low and sometimes the signals have a "fluttery" or "warbly" fade which is very characteristic. This is the result of the signals having been scattered so much that they arrive at the receiving point from random directions and in random phase relationships.

Several different forms of scatter propagation are known and are of use to amateurs. These include backscatter and sidescatter, tropospheric and ionospheric scatter, and transequatorial scatter. Tropospheric and transequatorial types are considered to be forward-scatter modes of propagation.

The troposphere, which lies between the earth and the ionosphere upward to a variable height of 8 to 20 km, is capable of supporting medium-distance communication with weak but very reliable signals regardless of the condition of the ionosphere. It is especially useful on vhf, where modest power and antennas may be employed to sustain 200-mile reliable communications paths. Higher power and bigger antennas can push the maximum path length for this mode to close to 500 miles in the amateur service. Tropospheric (or tropo) scatter signals show rapidly decreasing signal strength with increase in distance from their source, but signal strength decreases very slowly as a function of increase in frequency.

The *D* region, *E* and *F* layers are all useful for ionospheric scatter. Above the muf, where for the most part signals pass through, rather than being returned by the ionosphere, some signal does get returned to earth by means of being scattered off irregularities in the layers. These scattered signals may continue forward along the great-circle path or may be returned to the earth in any random direction. As with tropo-scattered signals, ionospheric scatter signals are quite weak. But because communication via this mode is possible from the higher layers of the ionosphere, the distances covered are also greater — up to 2000 km via *E* layer is possible. If the ionospheric layers are intact

(no SID or ionospheric storm in progress), ionospheric scatter may be used. Such communication requires higher power and bigger antennas than does tropospheric scatter, however.

Sidescatter and backscatter are offshoot forms of ionospheric propagation modes. Simply stated, it is possible to communicate with some distant point by routes other than direct (great-circle path), by "bouncing" a signal from an area of the earth which is reachable via the ionosphere from both ends of the path. For example, stations in each other's skip zone could communicate via backscatter during a "solid" band opening to a more distant area. If both stations are using rotatable directive arrays, optimum results will be obtained with beams directed toward the area for which the band is open, rather than toward each other. The characteristics of backscatter propagation are very weak but quite stable signals with essentially no fading. If the geographic area which is open to both terminals is very large, the signals may have a "hollow" or echo-effect sound, resulting from different propagation delays of the signals being scattered back and consequent differences in received phase relationships of the signal components. These effects are more pronounced if signals are scattered back over more than one hop, as may occasionally occur with high-gain directional antennas and transmitters running at powers near the legal amateur limit. Backscatter signals may be observed with dipole antennas and power levels below 100 watts if the frequency of operation is just below the muf.

Sidescatter propagation is closely related to that of backscatter, the only difference being that the signals which are bounced from the earth are scattered sideways, rather than back in the direction of the transmitter. For example, stations which are 5000 or 6000 km apart might establish usable communications on a frequency somewhat above the prevailing muf on the great-circle path between them, if there is a band opening from each terminal point to some common area off the side of the great-circle route. Under such conditions, signals will arrive at each terminal from a direction which may be dozens of degrees off the great-circle path. As with backscatter, optimum results will be obtained if rotatable beam antennas are pointed toward the area for which the band is open. All else being equal, sidescatter signals are considerably stronger than backscatter signals.

Transequatorial scatter (TE) is primarily useful for vhf work. The ionosphere over the equator is higher, thicker, and more densely ionized than it is elsewhere. Because of this, transequatorial ionospheric propagation is better than in other directions. This is also true of transequatorial scatter, which, at its extremes, can be useful up to about 8000 kilometers (5000 miles). The TE-mode muf is approximately 1.5 times the muf observed that day over the same path. Thus, if the daytime muf were to reach 35 MHz, then the TE-mode muf would reach about 52 MHz during the day. This mode is most useful on the amateur six-meter band. Two-meter propagation via this mode is considered impossible.

### Sporadic-E Propagation

At about the height of the *E* layer, highly ionized clouds are randomly and sporadically formed. They are small and last for only a few hours at a time. Because of their transient nature and their altitude, they are called *sporadic-E* clouds. To differentiate them from other *E*-layer phenomena these sporadic *E* clouds are designated  $E_S$ .

$E_S$  clouds vary in intensity and move rapidly from southeast to northwest, at midlatitudes in the northern hemisphere. In the northern hemisphere they occur predominantly from May through August, with a minor peak in midwinter. The seasonal months are reversed in the southern hemisphere.

The mechanism for the formation of  $E_S$  is believed to be wind shear. This explains ambient ionization being redistributed and compressed into a ledge of high density without the need for production of extra ionization. Neutral winds of high velocity, flowing in opposite directions at slightly different altitudes, produce shears and, in the presence of the geomagnetic field, the ions are collected at a particular altitude, forming a thin over-dense layer. Data from rockets penetrating  $E_S$  layers confirm the electron density, wind velocities, and height parameters.

Since midlatitude  $E_S$  is directly associated with terrestrial or meteorological rather than solar phenomena, it is not surprising that the occurrence of intense  $E_S$  does *not* show direct correlation with sunspot activity.

The occurrence of intense  $E_S$  is markedly reduced at middle latitudes when the earth's magnetic field is disturbed.

The muf of intense  $E_S$  clouds is a function of their ionization density. The highest frequency which can be propagated obliquely is not known, but propagation to approximately 200 MHz has been reported a number of times. The probability of a 144-MHz opening is about 3 to 4 percent of the occurrence of 50-MHz openings. However, signal strength observed over the vhf range does not appear to be frequency dependent.

Normal one-hop, single-cloud  $E_S$  DX is limited to about 1250 miles, but during the summer season multiple clouds are common, and most propagation is via more than one cloud. With the right distribution, distances up to 2500 miles or more are possible over land.

### Meteor Trails

Meteors entering the upper atmosphere travel at such high speed that a large amount of energy is released when the meteor is slowed down by friction with the air. Part of this is used in ionizing the atmosphere along the path followed by the meteor. Even a very small meteor can ionize a region 50 or more feet in diameter and a mile or so long. Such a region is large enough to refract the shorter wavelengths back to earth. The ions quickly recombine, however, so the effect of a meteor usually lasts only a short time — from a fraction of a second to a few seconds, in the average case. It is long enough, though, to produce a "burst" of

signal from stations not normally heard, or heard only weakly by scatter propagation. Bursts caused by meteors can be observed at amateur frequencies from 14 MHz through 220 MHz, with contacts having been made through 144 MHz.

In its movement through space, the earth rather frequently encounters swarms of meteors, or "meteor showers," which ionize the *E* region. During meteor showers the bursts are so frequent that it is sometimes possible to carry on continuous communication on 28 and 50 MHz by that means. Just as in the case of sporadic-*E* patches, the ionized meteor trail must be midway between two stations if a burst is to be heard, and the two stations must be separated by enough distance so that the wave angle will be low enough to be refracted. During some of the stronger bursts of the more intense showers, it is not unusual to have a signal enhanced by as much as 40 dB. Because the meteor trail is so short lived, communication relies on several (or many) parallel trails at one time. The result is a Doppler shift of as much as 2 kHz.

A table of meteor showers appears in Chapter 2 of *The Radio Amateur's VHF Manual*, published by the ARRL.

Meteor-scatter communication, being basically a single-hop mode, provides a maximum working distance of only about 1300 miles, the same as for any other *E*-layer single-hop mode of communication.

## PREDICTION CHARTS

Studies of the ionosphere and correlation of theories with observed signals from various distances over different paths have made it possible to estimate the median maximum usable frequencies (mufs) to be expected over any part of the earth for a particular smoothed sunspot number. Charts in the form of world maps with frequency contours are available for making frequency estimations manually. The maps and instructions for their use are contained in four volumes, pictured in Fig. 1-12.

With these four volumes, estimations of mufs may be made in advance for any month of any year, if the smoothed sunspot number (or a predicted value) is known. The use of the maps is explained in Vol. 1. Vols. 2, 3, and 4 each contain maps for predicted Zurich smoothed relative sunspot numbers of 10, 110, and 160, respectively. Linear interpolation of data from two of the latter three volumes must be made for periods of solar activity at intermediate levels. The maps provide data for the *E* and *F*<sub>2</sub> layers, with the *F*<sub>1</sub> layer also being taken into account.

It has been the experience of amateurs using these volumes that quite reliable frequency estimations are obtainable. Any observed departures tend to indicate that the estimated values are sometimes on the conservative side — that actual mufs for a given time over a given path may be slightly higher than estimated.

The four-volume set is called OT Telecommunications Research and Engineering Report *Iono-*



Fig. 1-12 — With these four volumes, frequency estimations for sky-wave signals can be made manually for any month of any year. The only other information required is the Zurich smoothed relative sunspot number for the period of interest.

*spheric Predictions*, OT-TRER 13, and may be obtained from the Superintendent of Documents, U.S. Government Printing Office, Washington, DC 20402, for \$9.30. Vol. 1 is available separately for 30 cents, and Vols. 2, 3, or 4 are available separately for \$3.00 each. Vol. 4 is not required unless estimations are being made for smoothed sunspot numbers greater than 110.

The Institute for Telecommunication Sciences (ITS), Boulder, Colo., issues weekly forecasts which contain effective solar activity indices (12-month moving-average Zurich sunspot numbers) for use with these volumes. For many amateurs, a more likely source of this information may be the Propagation Forecast Bulletins transmitted by W1AW on a regularly scheduled basis. These bulletins are revised weekly, containing a summary of the information from the ITS forecasts. W1AW transmission schedules are published monthly in *QST*, or may be obtained by writing ARRL Headquarters, 225 Main St., Newington, CT 06111.

## Bibliography

Source material and more extended discussion of topics covered in this chapter can be found in the references given below.

- Davies, National Bureau of Standards Monograph 80, *Ionospheric Radio Propagation*, Supt. of Documents, Washington 25, D.C.
- Hall, "High-Frequency Propagation Estimations for the Radio Amateur," *QST*, March, 1972.
- Jacobs and Leinwoll, "Short Wave Radio and the Ionosphere," *CQ*, November, 1969.
- Jacobs and Leinwoll, "VHF Ionospheric Propagation," *CQ*, November, 1969.
- Schultz, "Don't Be Afraid of the Big Bad Black-out," *CQ*, November, 1969.
- Terman, *Radio Engineering*, McGraw-Hill Book Co., New York, N. Y.
- The Radio Amateur's VHF Manual*, ARRL, Newington, Conn.
- Wilson, "Midlatitude Intense Sporadic-E Propagation," *QST*, December, 1970 (Part I) and March, 1971 (Part II).

# Antenna Fundamentals

An antenna is an electric circuit of a special kind. In the ordinary type of circuit the dimensions of coils, capacitors and connections usually are small compared with the wavelength that corresponds to the frequency in use. When this is the case most of the electromagnetic energy stays in the circuit itself and either is used up in performing useful work or is converted into heat. But when the dimensions of wiring or components become appreciable compared with the wavelength, some of the energy escapes by **radiation** in the form of electromagnetic waves. When the circuit is intentionally designed so that the major portion of the energy is radiated, we have an **antenna**.

Usually, the antenna is a straight section of conductor, or a combination of such conductors. Very frequently the conductor is a wire, although rods and tubing also are used. In this chapter we shall use the term "wire" to mean any type of conductor having a cross section that is small compared with its length.

The strength of the electromagnetic field radiated from a section of wire carrying radio-frequency current depends on the length of the wire and the amount of current flowing.† Other things being equal, the field strength will be directly proportional to the current. It is therefore desirable to make the current as large as possible, considering the power available. In any circuit that contains both resistance and reactance, the largest current will flow (for a given amount of power) when the reactance is "tuned out" — in other words, when the circuit is made **resonant** at the operating frequency. So it is with the common type of antenna; the current in it will be largest, and the radiation therefore greatest, when the antenna is resonant.

In an ordinary circuit the inductance is usually concentrated in a coil, the capacitance in a capacitor, and the resistance is principally concentrated in resistors, although some may be distrib-

† It would also be true to say that the field strength depends on the voltage across the section of wire, but it is generally more convenient to measure current. The electromagnetic field consists of both magnetic and electric energy, with the total energy equally divided between the two. One cannot exist without the other in an electromagnetic wave, and the voltage in an antenna is just as much a measure of the field intensity as the current.

uted around the circuit wiring and coil conductors. Such circuits are said to have **lumped constants**. In an antenna, on the other hand, the inductance, capacitance, and resistance are distributed along the wire. Such a circuit is said to have **distributed constants**. Circuits with distributed constants are so frequently straight-line conductors that they are customarily called linear circuits.

## RESONANCE IN LINEAR CIRCUITS

The shortest length of wire that will resonate to a given frequency is one just long enough to permit an electric charge to travel from one end to the other and then back again in the time of one rf cycle. If the speed at which the charge travels is equal to the velocity of light, approximately 300,000,000 meters per second, the distance it will cover in one cycle or period will be equal to this velocity divided by the frequency in hertz, or

$$\lambda = \frac{300,000,000}{f}$$

in which  $\lambda$  is the wavelength in meters. Since the charge traverses the wire *twice*, the length of wire needed to permit the charge to travel a distance  $\lambda$  in one cycle is  $\lambda/2$ , or **one-half wavelength**. Therefore the **shortest resonant wire** will be a half wavelength long.

The reason for this length can be made clear by a simple example. Imagine a trough with barriers at each end. If an elastic ball is started along the trough from one end, it will strike the far barrier, bounce back, travel along to the near barrier, bounce again, and continue until the energy imparted to it originally is all dissipated. If, however, whenever it returns to the near barrier it is given a new push just as it starts away, its back-and-forth motion can be kept up indefinitely. The impulses, however, must be *timed* properly; in other words, the rate or frequency of the impulses must be adjusted to the length of travel and the rate of travel. Or, if the timing of the impulses and the speed of the ball are fixed, the length of the trough must be adjusted to "fit."

In the case of the antenna, the speed is essentially constant, so we have the alternatives of adjusting the frequency to a given length of wire, or the length of wire to a given operating frequency. The latter is usually the practical condition.



By changing the units in the equation just given and dividing by 2, the formula

$$l = \frac{492}{f(\text{MHz})}$$

is obtained. In this case  $l$  is the length in feet of a half wavelength for a frequency  $f$ , given in megahertz, when the wave travels with the velocity of light. This formula is the basis upon which several significant lengths in antenna work are developed. It represents the length of a half wavelength in space, when no factors that modify the speed of propagation exist. To determine a half wavelength in meters, the relationship is

$$l = \frac{150}{f(\text{MHz})}$$

### Current and Voltage Distribution

If the wire in the first illustration had been infinitely long the charge (voltage) and the current (an electric current is simply a charge in motion) would both slowly decrease in amplitude with distance from the source. The slow decrease would result from dissipation of energy in the form of radio waves and in heating the wire because of its resistance. However, when the wire is short the charge is reflected when it reaches the far end, just as the ball bounced back from the barrier. With radio-frequency excitation of a half-wave antenna, there is of course not just a single charge but a continuous supply of energy, varying in voltage according to a sine-wave cycle. We might consider this as a series of charges, each of slightly different amplitude than the preceding one. When a charge reaches the end of the antenna and is reflected, the direction of current flow reverses, since the charge is now traveling in the opposite direction. However, the next charge is just reaching the end of the antenna, so we have two currents of practically the same amplitude flowing in opposite directions. The resultant current at the end of the antenna therefore is zero. As we move farther back from the end of the antenna the magnitudes of the outgoing and returning currents are no longer the same because the charges causing them have been supplied to the antenna at different parts of the rf cycle. There is less cancellation, therefore, and a measurable current exists. The greatest difference — that is, the largest resultant current — will be found to exist a quarter wavelength away from the end of the antenna. As we move back still farther from this point the current will decrease until, a half wavelength away from the end of the antenna, it will reach zero again. Thus, in a half-wave antenna the current is zero at the ends and maximum at the center.

This current distribution along a half-wave wire is shown in Fig. 2-1. The distance measured vertically from the antenna wire to the curve marked "current," at any point along the wire, represents the relative amplitude of the current as measured by an ammeter at that point. This is called a **standing wave of current**. The instantane-

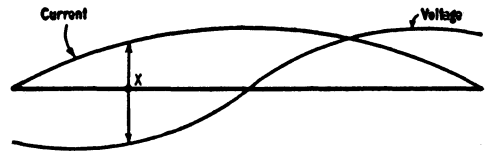

Fig. 2-1 — Current and voltage distribution on a half-wave wire. In this conventional representation the distance at any point ( $X$ , for instance) from the wire, represented by the heavy line, to the curve gives the relative intensity of current or voltage at that point. The relative direction of current flow (or polarity of voltage) is indicated by drawing the curve either above or below the line that represents the antenna. The curve above, for example, shows that the instantaneous polarity of the voltage in one half of the antenna is opposite to that in the other half.

ous value of current at any point varies sinusoidally at the applied frequency, but its amplitude is different at every point along the wire as shown by the curve. The standing-wave curve itself has the shape of a half sine wave, at least to a good approximation.

The voltage along the wire will behave differently; it is obviously greatest at the end since at this point we have two practically equal charges adding. As we move back along the wire, however, the outgoing and returning charges are not equal and their sum is smaller. At the quarter-wave point the returning charge is of equal magnitude but of opposite sign to the outgoing charge, since at this time the polarity of the voltage wave from the source has reversed (one-half cycle). The two voltages therefore cancel each other and the resultant voltage is zero. Beyond the quarter-wave point, away from the end of the wire, the voltage again increases, but this time with the opposite polarity.

It will be observed, therefore, that the voltage is maximum at every point where the current is minimum, and vice versa. The polarity of the current or voltage reverses every half wavelength along the wire, but the reversals do not occur at the same points for both current and voltage; the respective reversals occur, in fact, at points a quarter wave apart.

A maximum point on a standing wave is called a **loop** (or **antinode**); a minimum point is called a **node**.

### Harmonic Operation

If there is reflection from the end of a wire, the number of standing waves on the wire will be equal to the length of the wire divided by a half wavelength. Thus, if the wire is two half waves long there will be two standing waves; if three half waves long, three standing waves, and so on. These longer wires, each multiples of a half wave in length, will also be resonant, therefore, at the same frequency as the single half-wave wire. When an antenna is two or more half waves in length at the operating frequency it is said to be **harmonically**

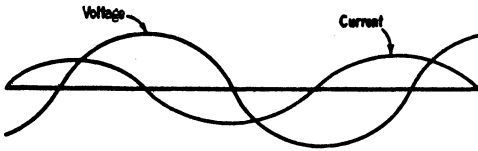

Fig. 2-2 — Harmonic operation of a long wire. The wire is long enough to contain several half waves. The current and voltage curves cross the heavy line representing the wire to indicate that there is reversal in the direction of the current, and a reversal in the polarity of the voltage, at intervals of a half wavelength. The reversals of current and voltage do not coincide, but occur at points a quarter wavelength apart.

resonant, or to operate at a harmonic. The number of the harmonic is the number of standing waves on the wire. For example, a wire two half waves long is said to be operating on its **second harmonic**; one three half waves long on its **third harmonic**, and so on.

Harmonic operation is often utilized in antenna work because it permits operating the same antenna on several harmonically related amateur bands. It is also an important principle in the operation of certain types of directive antennas.

**Electrical Length**

The *electrical* length of a linear circuit such as an antenna wire is not necessarily the same as its *physical* length in wavelengths or fractions of a wavelength. Rather, the electrical length is measured by the *time* taken for the completion of a specified phenomenon.

For instance, we might imagine two linear circuits having such different characteristics that the speed at which a charge travels is not the same in both. Suppose we wish to make both circuits resonant at the same frequency, and for that purpose adjust the physical length of each until a charge started at one end travels to the far end, is reflected and completes its return journey to the

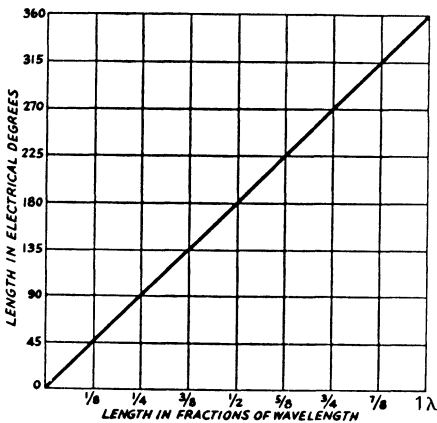

Fig. 2-3 — Chart for converting electrical degrees to fractions of a wavelength.

near end in exactly the time of one rf cycle. Then it will be found that the physical length of the circuit with the lower velocity of propagation is shorter than the *physical* length of the other. The *electrical* lengths, however, are identical, each being a half wavelength.

In alternating-current circuits the instantaneous values of current or voltage are determined by the instant during the cycle at which the measurement is made (assuming, of course, that such a measurement could be made rapidly enough). If the current and voltage follow a sine curve — which is the usual case — the time, for any instantaneous value, can be specified in terms of an angle. The sine of the angle gives the instantaneous value when multiplied by the *peak* value of the current or voltage. A complete sine curve occupies the 360 degrees of a circle and represents one cycle of ac current or voltage. Thus a half cycle is equal to 180 degrees, a quarter cycle to 90 degrees, and so on.

It is often convenient to use this same form of representation for linear circuits. When the electrical length of a circuit is such that a charge *traveling in one direction* takes the time of one cycle or period to traverse it, the length of the circuit is said to be 360 degrees. This corresponds to one wavelength. On a wire a half wave in electrical length, the charge completes a one-way journey in one half cycle and its length is said to be 180 degrees. The angular method of measurement is quite useful for lengths that are not easily remembered fractions or simple multiples of such fractions. A chart for converting fractions of a wavelength to degrees is given in Fig. 2-3.

**Velocity of Propagation**

The velocity at which electromagnetic waves travel through a medium depends upon the dielectric constant of the medium. At rf the dielectric constant of air is practically unity, so the waves travel at essentially the same velocity as light in a vacuum. This is also the velocity, very closely, of the charge traveling along a wire.

If the dielectric constant is greater than 1, the velocity of propagation is lowered. Thus the introduction, in appreciable quantity, of insulating material having a dielectric constant greater than 1 will cause the wave to slow down. This effect is encountered in practice in connection with both antennas and transmission lines. It causes the electrical length of the line or antenna to be greater than actual physical length.

**Length of a "Half-Wave" Antenna**

Even if the antenna could be supported by insulators that did not cause the electromagnetic fields traveling along the wire to slow down, the physical length of a practical antenna always is somewhat less than its electrical length. That is, a "half-wave" antenna is not one having the same length as a half wavelength in space. It is one having an *electrical* length equal to 180 degrees. Or, to put it another way, it is one with a length which has been adjusted to "tune out" any reactance, so it is a *resonant* antenna.

The antenna length required to resonate at a given frequency (independently of any dielectric effects) depends on the ratio of the length of the conductor to its diameter. The smaller this ratio (or the "thicker" the wire), the shorter the antenna for a given electrical length. This effect is shown in Fig. 2-4 as a factor ( $K$ ) by which a free-space half wavelength must be multiplied to find the resonant length, as a function of the ratio of the free-space half wavelength to conductor diameter, known as the length/diameter ratio. The curve is based on theoretical considerations and is useful as a guide to the probable antenna length for a given frequency. It applies only to conductors of uniform diameter (tapered elements such as are used in some types of beam antennas will generally be longer, for the same frequency) and does not include any effects introduced by the method of supporting the conductor.

A length/diameter ratio of 10,000 is roughly average for wire antennas (actually, it is approximately the ratio for a 7-MHz half-wave antenna made of No. 12 wire). In this region  $K$  changes rather slowly and a half-wave antenna made of wire is about 2 percent shorter than a half wavelength in space.

The shortening effect is most pronounced when the length/diameter ratio is 100 or less. An antenna constructed of 1-inch diameter tubing for use on 144 MHz for example, would have a length/diameter ratio of about 40 and would be almost 5 percent shorter than a free-space half wavelength.

If the antenna is made of rod or tubing and is not supported near the ends by insulators, the following formula will give the required physical length of a half-wave antenna based on Fig. 2-4.

$$\text{Length (feet)} = \frac{492 \times K}{f \text{ (MHz)}}$$

or

$$\text{Length (inches)} = \frac{5905 \times K}{f \text{ (MHz)}}$$

or

$$\text{Length (meters)} = \frac{150 \times K}{f \text{ (MHz)}}$$

where  $K$  is taken from Fig. 2-4 for the particular length/diameter ratio of the conductor used.

### End Effect

If the formulas of the preceding section are used to determine the length of a wire antenna, the antenna will resonate at a somewhat lower frequency than is desired. The reason for this is that there is an additional "loading" effect caused by the insulators that must be used at the ends of the wire for suspending it. These insulators and the wire loop that ties the insulator to the antenna add a small amount of capacitance to the system. This capacitance helps to tune the antenna to a slightly lower frequency, in much the same way that additional capacitance in any tuned circuit will lower the resonant frequency. In an antenna it is called **end effect**. The current at the ends of the antenna does not quite reach zero because of the

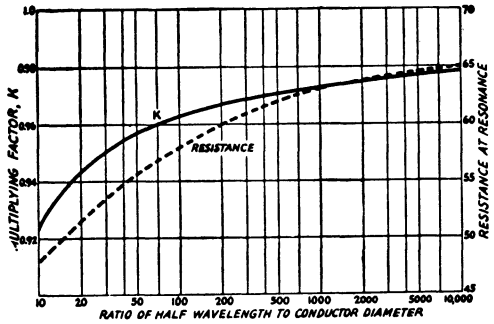

Fig. 2-4 — The solid curve shows the factor,  $K$ , by which the length of a half wave in free space should be multiplied to obtain the physical length of a resonant half-wave antenna having the length/diameter ratio shown along the horizontal axis. The broken curve shows how the radiation resistance of a half-wave antenna varies with the length/diameter ratio.

end effect, as there is some current flowing into the end capacitance.

End effect increases with frequency and varies slightly with different installations. However, at frequencies up to 30 MHz (the frequency range over which wire antennas are most likely to be used) experience shows that the length of a half-wave antenna is of the order of 5 percent less than the length of a half wave in space. As an average, then, the physical length of a resonant half-wave antenna may be taken to be

$$l \text{ (feet)} = \frac{492 \times 0.95}{f \text{ (MHz)}} = \frac{468}{f \text{ (MHz)}}$$

Similarly

$$l \text{ (meters)} = \frac{142}{f \text{ (MHz)}}$$

These formulas are reasonably accurate for finding the physical length of a half-wave antenna for a given frequency, but do not apply to antennas longer than a half wave in length. In the practical case, if the antenna length must be adjusted to exact frequency (not all antenna systems require it) the length should be "pruned" to resonance.

### ANTENNA IMPEDANCE

In the simplified description given earlier of voltage and current distribution along an antenna it was stated that the voltage was zero at the center of a half-wave antenna (or at any current loop along a longer antenna). It is more accurate to say that the voltage reaches a *minimum* rather than zero. Zero voltage with a finite value of current would imply that the circuit is entirely without resistance. It would also imply that no energy is radiated by the antenna, since a circuit without

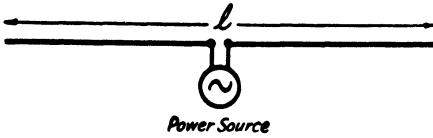

Fig. 2-5 — The center-fed antenna discussed in the text. It is assumed that the leads from the source of power to the antenna have zero length.

resistance would take no real power from the driving source.

Actually, of course, an antenna, like any other circuit, consumes power. The current that flows in it therefore must be supplied at a finite value of voltage. The **impedance** of the antenna is simply equal to the voltage applied to its terminals divided by the current flowing into those terminals. If the current and voltage are exactly in phase the impedance is purely resistive. This is the case when the antenna is resonant. If the antenna is not exactly resonant the current will be somewhat out of phase with the applied voltage and the antenna shows reactance along with resistance.

Most amateur transmitting antennas are operated at or quite close to resonance so that reactive effects are in general comparatively small. They are nevertheless present, and must be taken into account whenever an antenna is operated at other than the exact design frequency.

In the following discussion it is assumed that power is applied to the antenna by opening the conductor at the center and applying the driving voltage across the gap. This is shown in Fig. 2-5. While it is possible to supply power to the antenna by other methods, the selection of different driving points leads to different values of impedance; this can be appreciated after study of Fig. 2-1, which shows that the ratio of voltage to current (which is, by definition, the impedance) is different at every point along the antenna. To avoid confusion it is desirable to use the conditions at the center of the antenna as a basis.

#### The Antenna as a Circuit

If the frequency applied at the center of a half-wave antenna is varied above and below the resonant frequency, the antenna will exhibit much the same characteristics as a conventional series-resonant circuit. Exactly at resonance the current at the input terminals will be in phase with the applied voltage. If the frequency is on the low side of resonance the phase of the current will lead the voltage; that is, the reactance of the antenna is capacitive. When the frequency is on the high side of resonance the opposite occurs; the current lags the applied voltage and the antenna exhibits inductive reactance.

It is not hard to see why this is so. Consider the antennas shown in Fig. 2-6, one resonant, one too long for the applied frequency, and one too short. In each case the applied voltage is shown at A, and the instantaneous current going *into* the antenna because of the applied voltage is shown at B. Note

that this current is always in phase with the applied voltage, regardless of the antenna length. For the sake of simplicity only the current flowing in one leg of the antenna is considered; conditions in the other leg are similar.

In the case of the resonant antenna, the current travels out to the end and back to the driving point in one half cycle, since one leg of the antenna is 90 degrees long and the total path out and back is therefore 180 degrees. This would make the phase of the *reflected* component of current differ from that of the outgoing current by 180 degrees, since the latter current has gone through a half cycle in the meantime. However, it will be remembered that there is a phase shift of 180 degrees at the end of the antenna, because the direction of current reverses at the end. The *total* phase shift between the outgoing and reflected currents, therefore, is 360 degrees. In other words, the reflected component arrives at the driving point exactly in phase with the outgoing component. The reflected component, shown at C, adds to the outgoing component to form the resultant or total current at the driving point. The resultant current is shown at D, and in the case of the resonant antenna it is easily seen that the resultant is exactly in phase with the applied voltage. This being the case, the load seen by the source of power is a pure resistance.

Now consider the antenna that is too short to be resonant. The outgoing component of current is still in phase with the applied voltage, as shown at B. The reflected component, however, gets back to the driving point *too soon*, because it travels over a path less than 180 degrees, out and back. This means that the maximum value of the reflected

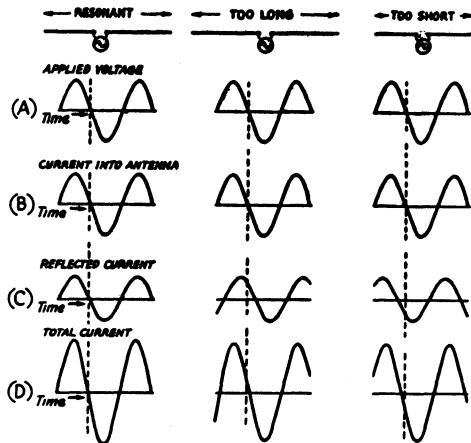

Fig. 2-6 — Current flow in resonant and off-resonant antennas. The initial current flow, B, caused by the source of power, is in phase with the applied voltage, A. This is the outgoing current discussed in the text. The reflected current, C, combines with the outgoing current to form the resultant current, D, at the input terminals of the antenna.

component occurs at the driving point ahead of (in time) the maximum value of the outgoing component, since that particular charge took less than a half cycle to get back. Including the 180-degree reversal at the end of the antenna, the total phase shift is therefore less than 360 degrees. This is shown at C, and the resultant current is the combination of the outgoing and reflected components as given at D. It can be seen that the resultant current leads the applied voltage, so the antenna looks like a resistance in series with a capacitance. The shorter the antenna, the greater the phase shift between voltage and current; that is, the capacitive reactance increases as the antenna is shortened.

When the antenna is too long for the applied frequency the reflected component of current arrives too late to be exactly in phase with the outgoing component, because it must travel over a path more than 180 degrees long. The maximum value of the reflected component therefore occurs later (in time) than the maximum value of the outgoing component, as shown at C. The resultant current at the antenna input terminals therefore lags behind the applied voltage. The phase lag increases as the antenna is made longer. That is, an antenna that is too long shows inductive reactance along with resistance, and this reactance increases with an increase in antenna length over the length required for resonance.

If the antenna length is increased to 180 degrees on each leg, the go-and-return path length for the current becomes 360 degrees. This, plus the 180-degree reversal at the end, makes the total phase shift 540 degrees, which is the same as a 180-degree shift. In this case the reflected current arrives at the input terminals exactly *out* of phase with the outgoing component, so the resultant current is very small. The resultant is in phase with the applied voltage, so the antenna impedance is again purely resistive. The resistance under these conditions is very high, and the antenna has the characteristics of a parallel-resonant circuit. A *voltage* loop, instead of a *current* loop, appears at the input terminals when each leg of the antenna is 180 degrees long.

The amplitude of the reflected component is less than that of the component of current going into the antenna. This is the result of energy loss by radiation as the current travels along the wire. It is perhaps easier to understand if, instead of thinking of the electromagnetic fields as being brought into being by the current flow, we adopt the more fundamental viewpoint that *current flow along a conductor is caused by a moving electromagnetic field*. When some of the energy escapes from the system because the field travels out into space, it is not hard to understand why the current becomes less as it travels farther. There is simply less energy left to cause it. The difference between the outgoing- and reflected-current amplitudes accounts for the fact that the current does not go to zero at a voltage loop, and a similar difference between the applied- and reflected-voltage components explains why the voltage does not go to zero at a current loop.

### Resistance

The energy supplied to an antenna is dissipated in the form of radio waves and in heat losses in the wire and nearby dielectrics. The radiated energy is the useful part, but so far as the antenna is concerned it represents a loss just as much as the energy used in heating the wire is a loss. In either case the dissipated power is equal to  $I^2 R$ : in the case of heat losses,  $R$  is a real resistance, but in the case of radiation  $R$  is an assumed resistance, which, if present, would dissipate the power that is actually radiated from the antenna. This fictitious resistance is called the radiation resistance. The total power loss in the antenna is therefore equal to  $I^2 (R_0 + R)$ , where  $R_0$  is the radiation resistance and  $R$  the real resistance, or ohmic resistance.

In the ordinary half-wave antenna operated at amateur frequencies the power lost as heat in the conductor does not exceed a few percent of the total power supplied to the antenna. This is because the rf resistance of copper wire even as small as No. 14 is very low compared with the radiation resistance of an antenna that is reasonably clear of surrounding objects and is not too close to the ground. Therefore it can be assumed that the ohmic loss in a reasonably well-located antenna is negligible, and that all of the resistance shown by the antenna is radiation resistance. As a radiator of electromagnetic waves such an antenna is a highly efficient device.

The value of radiation resistance, as measured at the center of a half-wave antenna, depends on a number of factors. One is the location of the antenna with respect to other objects, particularly the earth. Another is the length/diameter ratio of the conductor used. In "free space" — with the antenna remote from everything else — the radiation resistance of a resonant antenna made of an infinitely thin conductor is approximately 73 ohms. The concept of a free-space antenna forms a convenient basis for calculation because the modifying effect of the ground can be taken into account separately. If the antenna is at least several wavelengths away from ground and other objects, it can be considered to be in free space insofar as its own electrical properties are concerned. This condition can be met with antennas in the vhf and uhf range.

The way in which the free-space radiation resistance varies with the length/diameter ratio of a half-wave antenna is shown by the broken curve in Fig. 2-4. As the antenna is made thicker the radiation resistance decreases. For most wire antennas it is close to 65 ohms. It will usually lie between 55 and 60 ohms for antennas constructed of rod or tubing.

The actual value of the radiation resistance — at least so long as it is 50 ohms or more — has no appreciable effect on the radiation efficiency of the antenna. This is because the ohmic resistance is only of the order of 1 ohm with the conductors used for thick antennas. The ohmic resistance does not become important until the radiation resistance drops to very low values — say less than 10 ohms — as may be the case when several antennas are coupled together to form an array of elements.

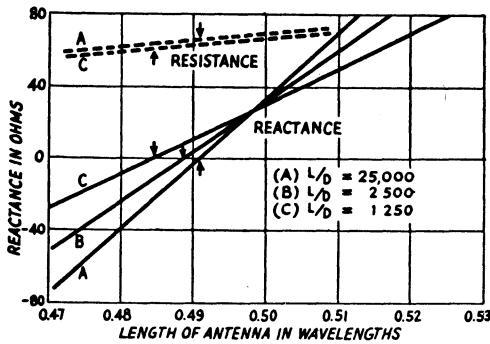

Fig. 2-7 — Resistance and reactance at input terminals of a center-fed antenna as a function of its length near a half wavelength. As shown by curves A, B and C, the reactance is affected more by the length/diameter ratio of the conductor than is the radiation resistance.

The radiation resistance of a resonant antenna is the “load” for the transmitter or for the rf transmission line connecting the transmitter and antenna. Its value is important, therefore, in determining the way in which the antenna and transmitter or line are coupled together.

The resistance of an antenna varies with its length as well as with the ratio of its length to its diameter. When the antenna is approximately a half wave long, the resistance changes rather slowly with length. This is shown by the curves of Fig. 2-7, where the change in resistance as the length is varied a few percent on either side of resonance is shown by the broken curves. The resistance decreases somewhat when the antenna is slightly short, and increases when it is slightly long. These curves also illustrate the effect of changing the frequency applied to an antenna of fixed length, since increasing the frequency above resonance is the same thing as having an antenna that is too long, and vice versa.

The range covered by the curves in Fig. 2-7 is representative of the frequency range over which a fixed antenna is operated between the limits of an amateur band. At greater departures from the resonant length the resistance continues to decrease somewhat uniformly as the antenna is shortened, but tends to increase rapidly as the antenna is made longer. The resistance increases very rapidly when the length of a leg exceeds about 135 degrees, or about 3/8 wavelength, and reaches a maximum when the length of one side is 180 degrees. This is considered in more detail in later sections of this chapter.

### Reactance

The rate at which the reactance of the antenna increases as the length is varied from resonance depends on the length/diameter ratio of the conductor. The thicker the conductor the smaller the reactance change for a given change in length. This is shown by the reactance curves in Fig. 2-7. Curves

for three values of length/diameter ratio are shown;  $L$  represents the length of a half wave in space, approximately, and  $D$  is the diameter of the conductor in the same units as the length. The point where each curve crosses the zero axis (indicated by an arrow in each case) is the length at which an antenna of that particular length/diameter ratio is resonant. The effect of  $L/D$  on the resonant length also is illustrated by these curves: the smaller the ratio, the shorter the length at which the reactance is zero.

It will be observed that the reactance changes about twice as rapidly in the antenna with the smallest diameter (A) as it does in the antenna with the largest diameter (C). With still larger diameters the rate at which the reactance changes would be even smaller. As a practical matter it is advantageous to keep the reactance change with a given change in length as small as possible. This means that when the antenna is operated over a small band of frequencies centered on its resonant frequency, the reactance is comparatively low, and that the impedance change with frequency is small. This simplifies the problem of supplying power to the antenna when it must be worked at frequencies somewhat different from its resonant frequency.

At lengths considerably different from the resonant length the reactance changes more rapidly than in the curves shown in Fig. 2-7. As in the case of the resistance change, the change is most rapid when the length exceeds 135 degrees (3/8 wavelength) and approaches 180 degrees (1/2 wavelength) on a side. In this case the reactance is inductive and reaches a maximum at a length somewhat less than 180 degrees. Between this maximum point and 180 degrees of electrical length the reactance decreases very rapidly, becoming zero when the length is such as to be parallel resonant.

Very short antennas have a large capacitive reactance. It was pointed out in the preceding section that with antennas shorter than 90 degrees on a side the resistance decreases at a fairly uniform rate, but this is not true of the reactance. It increases rather rapidly when the length of a side is shortened below about 45 degrees.

The behavior of antennas with different length/diameter ratios corresponds to the behavior of ordinary resonant circuits having different  $Q$ s. When the  $Q$  of a circuit is low, the reactance is small and changes rather slowly as the applied frequency is varied on either side of the resonant frequency. If the  $Q$  is high, the converse is true. The response curve of the low- $Q$  circuit is “broad”; that of the high- $Q$  circuit “sharp.” So it is with antennas; a thick antenna works well over a comparatively wide band of frequencies while a thin antenna is rather sharp in tuning. The  $Q$  of the thick antenna is low; the  $Q$  of the thin antenna is high, assuming essentially the same value of radiation resistance in both cases.

### Coupled Antennas

A conventional tuned circuit far enough away from all other circuits so that no external coupling

exists can be likened to an antenna in free space, in one sense. That is, its characteristics are unaffected by its surroundings. It will have a  $Q$  and resonant impedance determined by the inductance, capacitance and resistance of which it is composed, and those quantities alone. But as soon as it is coupled to another circuit its  $Q$  and impedance will change, depending on the characteristics of the other circuit and the degree of coupling.

A similar situation arises when two or more "elementary" antennas — half-wave antennas, frequently called **half-wave dipoles** — are coupled together. This coupling takes place merely by having the two antennas in proximity to each other. The sharpness of resonance and the radiation resistance of each "element" of the system are affected by the mutual interchange of energy between the coupled elements. The exact effect depends on the degree of coupling (that is, how close the antennas are to each other in terms of wavelength, and whether the wires are parallel or not) and the tuning condition (whether tuned to resonance or slightly off resonance) of each element. Analysis is extremely difficult and even then has to be based on some simplifying assumptions that may not be true in practice. Only a few relatively simple cases have been analyzed. Such data as are available for even moderately complicated systems of coupled antennas are confined to a few types and are based on experimental measurements. They are, therefore, subject to the inaccuracies that accompany any measurements in a field where measurement is difficult at best.

Antenna systems consisting of coupled elements will be taken up in later chapters. At this point it is sufficient to appreciate that the free-space values that have been discussed in this chapter may be modified drastically when more than one antenna element is involved in the system. It has already been pointed out that the presence of the ground, as well as nearby conductors or dielectrics, also will modify the free-space values. The free-space characteristics of the elementary half-wave dipole are only the point of departure for a practical antenna system. In other words, they give the basis for understanding antenna principles but cannot be applied too literally in the practical case.

It is of interest to note that the comparison between an isolated tuned circuit and an antenna in free space is likewise not to be taken too literally. In one sense the comparison is wholly misleading. The tuned circuit is usually so small, physically, in comparison with the wavelength, that practically no energy escapes from it by radiation. An antenna, to be worthy of the name, is always so large in comparison with the wavelength that practically *all* the energy supplied to it escapes by radiation. Thus, the antenna can be said to be very tightly coupled to space, while the tuned circuit is not coupled to anything. This very fundamental difference is one reason why antenna systems cannot be analyzed as readily, and with as satisfactory results in the shape of simple formulas, as ordinary electrical circuits.

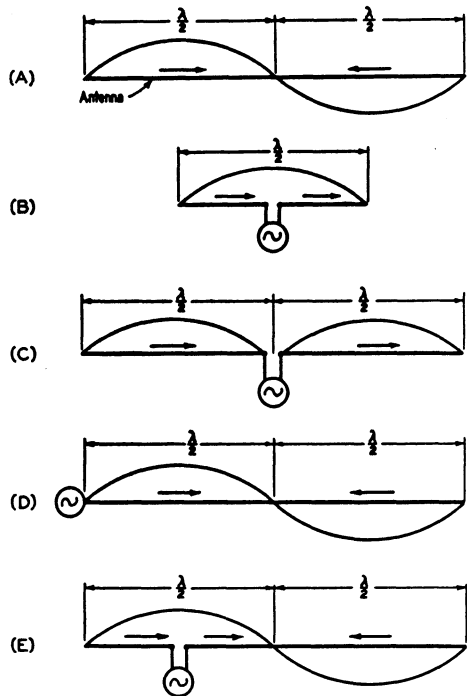

Fig. 2-8 — How the feed point makes a difference in current distribution along the antenna. With center feed, increasing the length of each side of the antenna keeps the current flowing in the same direction in the two halves, up to the point where each side is a half-wavelength long. For harmonic operation, the antenna must be fed in such a way that the current direction reverses in alternate half-wavelength sections. Suitable methods are shown at D and E.

### HARMONICALLY OPERATED ANTENNAS

An antenna operated at a harmonic of its fundamental frequency has considerably different properties than the half-wave dipole previously discussed. It must first be emphasized that harmonic operation implies that there is a reversal of the direction of current flow in alternate half-wave sections of the antenna, as shown in Fig. 2-2 and again at A in Fig. 2-8. In the latter figure, the curve shows the standing wave of current intensity along the wire; the curve is above the line to indicate current flow in one direction (assumed to be to the right, in the direction of the arrow) and below the line to indicate current flow in the opposite direction in the other half-wave section. (During the next radio-frequency half cycle the current flow in the left-hand half-wave section would be toward the left, and in the right-hand half-wave section to the right; this alternation in direction takes place in each succeeding half cycle. However, the direction of current flow in adjacent half-wave sections is at all times opposite.) The antenna in this drawing is one wavelength long and is operating on its second harmonic.

Now consider the half-wave antenna shown at Fig. 2-8B. It is opened in the center and fed by a source of rf power through leads that are assumed to have zero length. Since one terminal of the generator is positive at the same instant that the other terminal is negative, current flows *into* one side of the generator while it is flowing *out* at the other terminal. Consequently the current flows in the same direction in both sections of the half-wave antenna. It has the amplitude distribution shown by the curve over the antenna wire.

If we now increase the length of the wire on each side of the generator in Fig. 2-8B to one half wavelength, we have the situation shown in Fig. 2-8C. At the instant shown, current flows into the generator from the left-hand half-wave section, and out of the generator into the right-hand half-wave section. Thus the currents in the two sections are in the same direction, just as they were in Fig. 2-8B. The current distribution in this case obviously is not the same as in Fig. 2-8A. Although the over-all lengths of the antennas shown at A and C are the same, the antenna at A is operating on a harmonic but the one in C is not.

For true harmonic operation it is necessary that the power be fed into the antenna at the proper point. Two methods that result in the proper current distribution are shown at D and E in Fig. 2-8. If the source of power is connected to the antenna at one end, as in D, the direction of current flow will be reversed in alternate half-wave sections. Or if the power is inserted at the center of a half-wave section, as in E, there will be a similar reversal of current in the next half-wave section. For harmonic operation, therefore, the antenna should be fed either at the end or at a current loop. If the feed point is at a current node the current distribution will not be that expected on a harmonic antenna.

#### Length of a Harmonic Wire

The physical length of a harmonic antenna is not exactly the same as its electrical length, for the same reasons discussed earlier in connection with the half-wave antenna. The physical length is somewhat shorter than the length of the same number of half waves in space because of the length/diameter ratio of the conductor and the end effects. Since the latter are appreciable only where insulators introduce additional capacitance at a high-voltage point along the wire, and since a harmonic antenna usually has such insulation only at the ends, the end-effect shortening affects only the half-wave sections at each end of the antenna. It has been found that the following formulas for the length of a harmonic antenna of the usual wire sizes work out very well in practice:

$$\text{Length (feet)} = \frac{492 (N - .05)}{f \text{ (MHz)}}$$

or

$$\text{Length (meters)} = \frac{150 (N - .05)}{f \text{ (MHz)}}$$

where  $N$  is the number of *half* waves on the antenna.

Because the number of half waves varies with the harmonic on which the antenna is operated, consideration of the formulas together with that for the half-wave antenna (the fundamental frequency) will show that the relationship between the antenna fundamental frequency and its harmonics is not exactly integral. That is, the "second-harmonic" frequency to which a given length of wire is resonant is not exactly twice its fundamental frequency; the "third-harmonic" resonance is not exactly three times its fundamental, and so on. The actual resonant frequency on a harmonic is always a little higher than the exact multiple of the fundamental. A full-wave (second-harmonic) antenna, for example, must be a little longer than twice the length of a half-wave antenna.

Frequently it is desired to determine the electrical length of a harmonically operated wire antenna of fixed physical length for a given frequency. With a rearrangement of the terms of the above formulas, the following equation is useful for making these determinations:

$$\lambda = \frac{fL \text{ (feet)}}{984} + .025 = \frac{fL \text{ (meters)}}{300} + .025$$

where  $\lambda$  is the length of the wire in *wavelengths* at the frequency,  $f$ , in megahertz, and  $L$  is the physical length of the wire.

#### Impedance of Harmonic Antennas

A harmonic antenna can be looked upon as a series of half-wave sections placed end to end (collinear) and supplied with power in such a way that the currents in alternate sections are out of phase. There is a certain amount of coupling between adjacent half-wave sections. Because of this coupling, as well as the effect of radiation from the additional sections, the impedance as measured at a current loop in a half-wave section is not the same as the impedance at the center of a half-wave antenna.

Just as in the case of a half-wave antenna, the impedance consists of two main components, radiation resistance and reactance. The ohmic or loss resistance is low enough to be ignored in the practical case. If the antenna is exactly resonant there will be no reactance at the input terminals and the impedance consists only of the radiation resistance. The value of the radiation resistance depends on the number of half waves on the wire and, as in the case of the half-wave antenna, is modified by the presence of nearby conductors and dielectrics, particularly the earth. As a point of departure, however, it is of interest to know the order of magnitude of the radiation resistance of a theoretical harmonic antenna consisting of an infinitely thin conductor in free space, with its length adjusted to exact harmonic resonance. The radiation resistance of such an antenna having a length of one wavelength is approximately 90 ohms, and as the antenna length is increased the resistance also increases. At ten wavelengths it is approximately 160 ohms, for example. The way in which the radiation resistance of a theoretical



harmonic wire varies with length is shown by curve A in Fig. 2-20. It is to be understood that the radiation resistance is always measured at a current loop.

When the antenna is operated at a frequency slightly off its exact resonant frequency, reactance as well as resistance will appear at its input terminals. In a general way, the reactance varies with applied frequency in much the same fashion as in the case of the half-wave antenna already described. However, the reactance varies *at a more rapid rate* as the applied frequency is varied; on a harmonic antenna a given percentage change in applied frequency causes a greater change in the phase of the reflected current as related to the outgoing current than is the case with a half-wave antenna. This is because, in traveling the greater length of wire in a harmonic antenna, the reflected current gains the same amount of time in *each* half-wave section, if the antenna is too short for resonance, and these gains add up as the current travels back to the driving point. When the antenna is too long, the reverse occurs and the reflected current progressively drops behind in phase as it travels back to the point at which the voltage is applied. This effect increases with the length of the antenna, and the change of phase can be quite rapid when the frequency applied to an antenna operated on a high-order harmonic is varied.

Another way of looking at it is this: Consider the antenna of Fig. 2-9A, driven at the end by a source of power having a frequency  $1/2 f$ , where  $f$  is the fundamental or half-wave resonant frequency of the antenna. When the frequency  $1/2 f$  is applied, there is one quarter wavelength on the wire, with the current distribution as shown. At this frequency the antenna is resonant, and it appears as a pure resistance of low value to the source of power because the current is large and the voltage is small at the feed point.

If the frequency is now increased slightly the antenna will be too long and the resultant current at the input terminals will lag behind the applied voltage (as explained by Fig. 2-6), and the antenna will have inductive reactance along with resistance. As we continue to raise the frequency, the value of reactance increases to a maximum and then decreases, reaching zero when the frequency is  $f$ , such that the wire is a half wavelength long, shown at B. On further increasing the frequency, the reactance becomes capacitive, increases to a maximum, and then decreases, reaching zero when the wire is an odd number of quarter wavelengths long. As the frequency is increased still further, the reactance again becomes inductive, reaches a maximum, and again goes to zero at frequency  $2f$ . At this point there are two complete standing waves of current (two half waves or one wavelength) and the wire is exactly resonant on its second harmonic. This last condition is shown in Fig. 2-9C.

In varying the frequency from  $1/2 f$  to  $2f$ , the resistance seen by the source of power also varies. This resistance increases as the frequency is raised above  $1/2 f$  and reaches a maximum when the wire is a half wavelength long, decreases as the frequency is raised above  $f$ , reaching a minimum when the

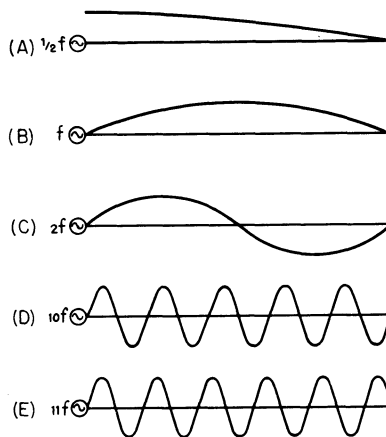

Fig. 2-9 — The percentage frequency change from one high-order harmonic to the next (for example, between the 10th and 11th harmonics shown at C and D) is much smaller than between the fundamental and second harmonic (A and B). This makes impedance variations more rapid as the wire becomes longer in terms of wavelength.

wire is an odd number of quarter wavelengths long, then rises again with increasing frequency until it reaches a new maximum when the frequency is  $2f$ .

This behavior of reactance and resistance is shown in Fig. 2-10. A similar change in reactance and resistance occurs when the frequency is moved from *any* harmonic to the *next adjacent* one, as well as between the fundamental and second harmonic shown in the drawing. That is, the impedance goes through a cycle, starting with a high value of pure resistance at  $f$  then becoming capacitive and decreasing, passing through a low value of pure resistance, and then becoming inductive and increasing until it again reaches a high value of pure resistance at  $2f$ . This cycle occurs as the frequency is continuously varied from any harmonic to the next higher one.

Looking now at Fig. 2-9D, the frequency has been increased to  $10f$ , ten times its original value, so the antenna is operated on its tenth harmonic. Raising the frequency to  $11f$ , the eleventh harmonic, causes the impedance of the antenna to go through the complete cycle described above. But  $11f$  is only 10% higher than  $10f$ , so a 10% change in frequency has caused a complete impedance cycle. In contrast, changing from  $f$  to  $2f$  is a 100% increase in frequency — for the same impedance cycle. The impedance changes ten times as fast when the frequency is varied about the 10th harmonic as it does when the frequency is varied the same percentage about the fundamental.

To offset this, the actual impedance change — that is, the ratio of the maximum to the minimum impedance through the impedance cycle — is not as great at the higher harmonics as it is near the fundamental. This is because the radiation resistance increases with the order of the harmonic, raising the minimum point on the resistance curve

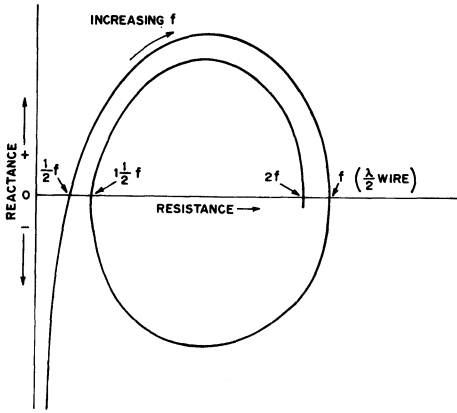

Fig. 2-10 — This drawing shows qualitatively the way in which the reactance and resistance of an end-fed antenna vary as the frequency is increased from one half the fundamental ( $1/2 f$ ) to the second harmonic ( $2f$ ). Relative resistance values are shown on the horizontal axis, and reactance values on the vertical axis; increasing frequency appears in a clockwise direction on the curve. Actual values of resistance and reactance and the frequencies at which the reactances are maximum will depend on the size of the conductor and the height of the antenna above ground.

and also lowering the maximum point. If the curve of Fig. 2-10 were continued through higher order harmonics, it would thus spiral inward, toward a central point. This comes about because the reflected current returning to the input end of a long harmonic wire is not as great as the outgoing current since energy has been lost by radiation; this is not taken into account in the theoretical pictures of current distribution so far discussed.

The overall result, then, is that the *magnitude* of the impedance variations becomes less as the wire is operated at increasingly higher harmonics. Nevertheless, the impedance reaches a maximum at each adjacent harmonic and a minimum halfway between, independently of the actual values of impedance.

## OTHER ANTENNA PROPERTIES

### Polarization

The polarization of a half-wave dipole is the same as the direction of its axis. That is, at distances far enough from the antenna for the waves to be considered as plane waves (see Chapter One) the direction of the electric component of the field is the same as the direction of the antenna wire. Vertical and horizontal polarization, the two most commonly used for antennas, are indicated in Fig. 2-11.

Antennas composed of a number of half-wave elements with all arranged so that their axes lie in the same or parallel directions will have the same

polarization as that of any one of the elements. A system composed of a group of horizontal dipoles, for example, will be horizontally polarized. If both horizontal and vertical elements are used and radiate in phase, the polarization will be the *resultant* of the contributions made by each set of elements to the total electromagnetic field at a distance. In such a case the resultant polarization will be *linear*, tilted between horizontal and vertical. If vertical and horizontal elements are fed out of phase, where the beginning of the rf period applied to the feed point of the vertical elements is not in time coincidence with that applied to the horizontal, the resultant polarization will be either *elliptical* or *circular*. With circular polarization, the wave front, as it appears in passing to a fixed observer, rotates every quarter period between vertical and horizontal, making a complete 360-degree rotation once every period. Field intensities are equal at all instantaneous polarizations. Circular polarization is frequently used for space communications.

Harmonic antennas also are polarized in the direction of the wire axis. However, in some combinations of harmonic wires such as the V and rhombic antennas described in a later chapter, the polarization becomes elliptical in most directions with respect to the antenna.

As pointed out in Chapter One, sky-wave transmission usually changes the polarization of the traveling waves. The polarization of receiving and transmitting antennas in the 3- to 30-MHz range, where almost all communication is by means of the sky wave (except for distances of a few miles), therefore need not be the same at both ends of a communication circuit. In this range the choice of polarization for the antenna is usually determined by factors such as the height of available antenna supports, the polarization of man-made rf noise from nearby sources, probable energy losses in nearby houses, wiring, etc., and the likelihood of interfering with neighborhood broadcast or TV reception.

### Reciprocity in Receiving and Transmitting

The basic conditions existing when an antenna is used for radiating power are not the same as when it is used for receiving a distant signal. In the

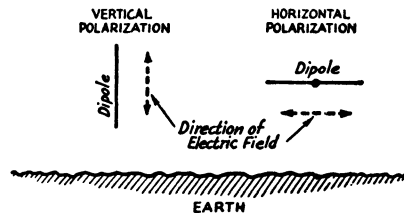

Fig. 2-11 — Vertical and horizontal polarization of a dipole. The direction of polarization is the direction of the electric field with respect to earth.

former case the electromagnetic field originates with the antenna and the waves are not plane-polarized in the immediate vicinity. In the receiving case the antenna is always far enough away from the transmitter so that the waves which the antenna intercepts are plane-polarized. This causes the current distribution in a receiving antenna to be different than in a transmitting antenna except in a few special cases. These special cases, however, are those of most interest in amateur practice, since they occur when the antenna is resonant and is delivering power to a receiver.

For all practical purposes, then, the properties of a resonant antenna used for reception are the same as its properties in transmission. It has the same directive pattern in both cases, and so will deliver maximum signal to the receiver when the signal comes from the direction in which the antenna transmits best. The impedance of the antenna is the same, at the same point of measurement, in receiving as in transmitting.

In the receiving case, the antenna is to be considered as the *source* of power delivered to the receiver, rather than as the *load* for a source of power as in transmitting. Maximum output from the receiving antenna is secured when the load to which the antenna is connected is matched to the impedance of the antenna. Under these conditions half of the total power picked up by the antenna from the passing waves is delivered to the receiver and half is reradiated into space.

"Impedance matching" in the case of a receiving antenna does not have quite the same meaning as in the transmitting case. This is considered in later chapters.

The power gain (defined later in this chapter) in receiving is the same as the gain in transmitting, assuming that certain conditions are met. One such condition is that both the antenna under test and the comparison antenna (usually a half-wave antenna) work into load impedances matched to their own impedances so that maximum power is delivered in both cases. In addition, the comparison antenna should be oriented so that it gives maximum response to the signal used in the test; that is, it should have the same polarization as the incoming signal and should be placed so that its direction of maximum gain is toward the signal source.

In long-distance transmission and reception via the ionosphere the relationship between receiving and transmitting may not be exactly reciprocal. This is because the waves do not take exactly the same paths at all times and so may show considerable variation in alternate transmission and reception. Also, when more than one layer is involved in the wave travel it is sometimes possible for transmission to be good in one direction and reception to be poor in the other, over the same path. In addition, the polarization of the waves is shifted in the ionosphere, as pointed out in Chapter One. The tendency is for the arriving wave to be elliptically polarized, regardless of the polarization of the transmitting antenna, and a vertically polarized antenna can be expected to show no more difference between transmission and recep-

tion than a horizontal antenna. On the average, an antenna that transmits well in a certain direction will give favorable reception from the same direction, despite ionosphere variations.

### Pickup Efficiency

Although the transmitting and receiving properties of an antenna are, in general, reciprocal, there is another fundamental difference between the two cases that is of very great practical importance. In the transmitting case all the power supplied to the antenna is radiated (assuming negligible ohmic resistance) regardless of the physical size of the antenna system. For example, a 300-MHz half-wave radiator, which is only about 50 *cm* (19 *inches*) long, radiates every bit as efficiently as a 3.5-MHz half-wave antenna, which is about 41 *meters* (134 *feet*) long. But in receiving, the 300-MHz antenna does not abstract anything like the amount of energy from passing waves that the 3.5-MHz antenna does.

This is because the section of wave front from which the antenna can draw energy extends only about a quarter wavelength from the conductor. At 3.5 MHz this represents an area roughly 1/2 wavelength or 41 meters in diameter, but at 300 MHz the diameter of the area is only about 1/2 meter. Since the energy is evenly distributed throughout the wave front regardless of the wavelength, the effective area that the receiving antenna can utilize varies directly with the *square* of the wavelength. A 3.5-MHz half-wave antenna therefore picks up something like 7000 times as much energy as a 300-MHz half-wave antenna, the field strength being the same in both cases.

The higher the frequency, consequently, the less energy a receiving antenna has to work with. This, it should be noted, does not affect the *gain* of the antenna. In making gain measurements, both the antenna under test and the comparison antenna are working at the same frequency. Both therefore are under the same handicap with respect to the amount of energy that can be intercepted. Thus the effective area of an antenna at a given wavelength is directly proportional to its gain. Although the pickup efficiency decreases rapidly with increasing frequency, the smaller dimensions of antenna systems in the vhf and uhf regions make it relatively easy to obtain high gain. This helps to overcome the loss of received signal energy.

### The Induction Field

Throughout this chapter the fields we have been discussing are those forming the traveling electromagnetic waves — the waves that go long distances from the antenna. These are the radiation fields. They are distinguished by the fact that their intensity is inversely proportional to the distance and that the electric and magnetic components, although perpendicular to each other in the wave front, are in phase in time. Several wavelengths from the antenna, these are the only fields that need to be considered.

Close to the antenna, however, the situation is much more complicated. In an ordinary electric

circuit containing inductance or capacitance the magnetic field is a quarter cycle out of phase (in time) with the electric field. The intensity of these fields decreases in a complex way with distance from the source. These are the induction fields. The induction field exists about an antenna along with the radiation field, but dies away with much greater rapidity as the distance from the antenna is increased. At a distance equal to the wavelength divided by  $2\pi$ , or slightly less than  $1/6$  wavelength,

the two types of field have equal intensity.

Although the induction field is of no importance insofar as effects at a distance are concerned, it is important when antenna elements are coupled together, particularly when the spacing between elements is small. Also, its existence must be kept in mind in making field-strength measurements about an antenna. Error may occur if the measuring equipment is set up too close to the antenna system.

## RADIATION PATTERNS AND DIRECTIVITY

A graph showing the actual or relative intensity, at a fixed distance, as a function of the direction from the antenna system is called a radiation pattern. At the outset it must be realized that such a pattern is a three-dimensional affair and therefore cannot be represented in a plane drawing. The "solid" radiation pattern of an antenna in free space would be found by measuring the field strength at every point on the surface of an imaginary sphere having the antenna at its center. The information so obtained is then used to construct a solid figure such that the distance from a fixed point (representing the antenna) to the surface, in any direction, is proportional to the field strength from the antenna in that direction.

### THE ISOTROPIC RADIATOR

The radiation from a practical antenna never has the same intensity in all directions. The intensity may even be zero in some directions from the antenna; in others it may be greater than one would expect from an antenna that *did* radiate equally well in all directions. But even though no actual antenna radiates with equal intensity in all directions, it is nevertheless useful to assume that such an antenna exists. It can be used as a "measuring stick" for comparing the properties of actual antenna systems. Such a hypothetical antenna is called an isotropic radiator.

The solid pattern of an isotropic radiator, therefore, would be a sphere, since the field strength is the same in all directions. In any plane containing the isotropic antenna (which may be considered as a point in space, or a "point source") the pattern is a circle with the antenna at its center. The isotropic antenna has the simplest possible directive pattern; that is, it has no directivity at all.

An infinite variety of pattern shapes, some quite complicated, is possible with actual antenna systems.

### RADIATION FROM DIPOLES

In the analysis of antenna systems it is convenient to make use of another fictitious type of antenna called an elementary doublet or elementary dipole. This is just a very short length of conductor, so short that it can be assumed that the current is the same throughout its length. (In an actual antenna, it will be remembered, the current is different all along its length.) The radiation intensity from an elementary doublet is greatest at right angles to the line of the conductor, and decreases as the direction becomes more nearly in line with the conductor until, right off the ends, the intensity is zero. The directive pattern in a single plane, one containing the conductor, is

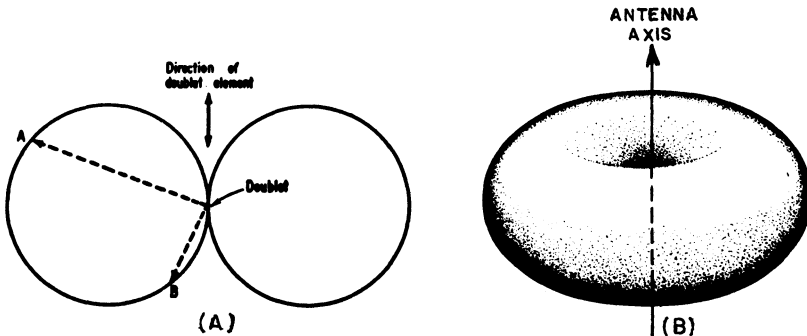

Fig. 2-12 — At A, directive diagram of an elementary doublet in the plane containing the wire axis. The length of each dash-line arrow represents the relative field strength in that direction. At B, the solid pattern of the same antenna. These same diagrams apply to any antenna considerably less than a half wavelength long.

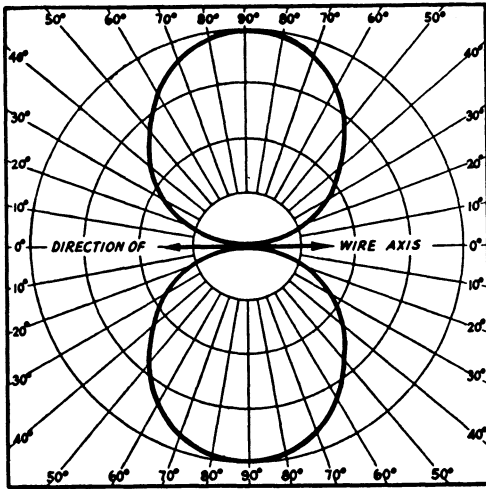

Fig. 2-13 — Plane directive diagram (*E* plane) of a half-wave antenna. The solid line shows the direction of the wire, although the antenna itself is considered to be merely a point at the center of the diagram. As explained in the text, a diagram such as this is simply a cross section of the solid figure that describes the relative radiation in all possible directions. The radial scale is purely arbitrary and is proportional to the field strength (voltage). This is also true of the diagram in Fig. 2-16.

shown in Fig. 2-12A. It consists of two tangent circles. The solid pattern is the doughnut-shaped figure which results when the plane shown in the drawing is rotated about the conductor as an axis, Fig. 2-12B.

The radiation from an elementary doublet is not uniform in all directions because there is a definite direction to the current flow along the conductor. It will be recalled that a similar condition exists in the ordinary electric and magnetic fields set up when current flows along any conductor; the field strength near a coil, for example, is greatest at the ends and least on the outside of the coil near the middle of its length. There is nothing strange, therefore, in the idea that the field strength should depend on the direction in which it is measured from the radiator.

When the antenna has appreciable length, so that the current in every part is not the same at any given instant, the shape of the radiation pattern changes. In this case the pattern is the summation of the fields from *each* elementary doublet of which the antenna may be assumed to consist, strung together in chain fashion. If the antenna is short compared with a half wavelength there is very little change in the pattern, but at a half wavelength the pattern takes the shape shown in cross section in Fig. 2-13. The intensity decreases somewhat more rapidly, as the angle with the wire is made smaller, than in the case of the elementary doublet. If the wire length is increased further, this tendency continues, with a wider null

appearing in the pattern off the ends of the wire as the antenna approaches a full wavelength. (The antenna is assumed to be driven at the center, as in Fig. 2-8B and 2-8C.) The solid pattern from a half-wave wire is formed, just as in the case of the doublet, by rotating the plane diagram shown in Fig. 2-13 about the wire as an axis.

The single-plane diagrams just discussed are actually cross sections of the solid pattern, cut by planes in which the axis of the antenna lies. If the solid pattern is cut by any other plane the diagram will be different. For instance, imagine a plane passing through the center of the wire at right angles to the axis. The cross section of the pattern for either the elementary doublet or the half-wave antenna will simply be a circle in that case. This is shown in Fig. 2-14 where the dot at the center represents the antenna as viewed "end on," as if one were looking into the top of the doughnut of Fig. 2-12B. In other words, the antenna is perpendicular to the page. This means that in any direction in a plane at right angles to the wire, the field intensity is exactly the same at the same distance from the antenna. At right angles to the wire, then, an antenna half wave or less in length is *nondirectional*. Also, at every point on such a circle the field is in the *same phase*.

### E- AND H-PLANE PATTERNS

The solid pattern of an antenna cannot adequately be shown with field-strength data on a flat sheet of paper. For this purpose, cross-sectional or *plane diagrams* are very useful. Two such diagrams, one in the plane containing the axis of the antenna and one in the plane perpendicular to the axis, can give a great deal of information. The former is called the *E*-plane pattern and the latter the *H*-plane pattern. These designations are used because they represent the planes in which the electric (symbol *E*), and the magnetic (symbol *H*) lines of force lie, respectively. The *E* lines are taken to represent the polarization of the antenna, consistent with the description of antenna polarization given earlier. The electromagnetic field pictured in Fig. 1-1, as an example, is the field that would be radiated from a vertically polarized

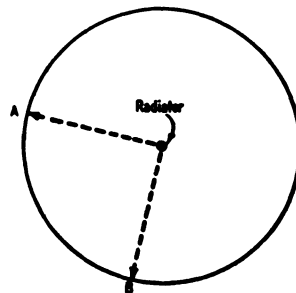

Fig. 2-14 — Directive diagram of a doublet or dipole in the plane perpendicular to the wire axis (*H* plane). The direction of the wire is into or out of the page.

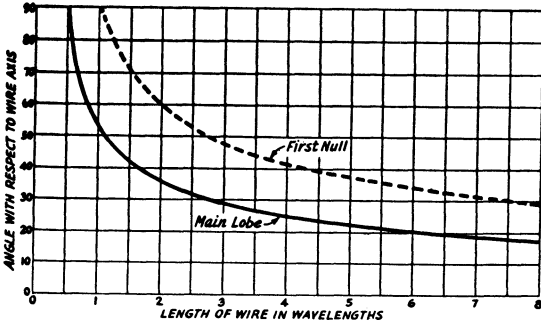

Fig. 2-15 — Angle at which the field intensity from the main lobe of a harmonic antenna is maximum, as a function of the wire length in wavelengths. The curve labeled "First Null" locates the angle at which the intensity of the main lobe decreases to zero. The null marking the other boundary of the main lobe always is at zero degrees with the wire axis.

antenna; that is, an antenna in which the conductor is mounted vertically over the earth.

After a little practice, and with the exercise of a little imagination, the complete solid pattern can be visualized with fair accuracy from inspection of just the two diagrams. Plane diagrams are plotted on polar-coordinate paper — graph paper with radial lines marking the 360 degrees of a circle, and having a linear scale along the radii for marking amplitudes. The points on the pattern where the radiation is zero are called nulls, and the curved section from one null to the next on the plane diagram, or the corresponding section on the solid pattern, is called a lobe or ear.

**HARMONIC-ANTENNA PATTERNS**

In view of the change in radiation pattern as the length of the antenna is increased from the elementary doublet to the half-wave dipole, it is to be expected that further pattern changes will occur as the antenna is made still longer. We find, as a matter of fact, that the patterns of harmonic antennas differ very considerably from the pattern of the half-wave dipole.

As explained earlier in this chapter, a harmonic antenna consists of a series of half-wave sections with the currents in adjacent sections always flowing in opposite directions. This type of current flow causes the pattern to be split up into a number of lobes. If there is an *even* number of half-waves in the harmonic antenna there is always a null in the plane at right angles to the wire; this is because the radiation from one half-wave section cancels the radiation from the next, in that particular direction. If there is an *odd* number of half-waves in the antenna, the radiation from all but one of the sections cancels itself out in the plane perpendicular to the wire. The "left-over" section radiates like a half-wave dipole, and so a harmonic antenna with an odd number of half

wavelengths does have some radiation at right angles to its axis.

The greater the number of half waves in a harmonic antenna, the larger the number of lobes into which the pattern splits. A feature of all such patterns is the fact that the "main" lobe — the one that gives the largest field strength at a given distance — always is the one that makes the smallest angle with the antenna wire. Furthermore, this angle becomes smaller as the length of the antenna is increased. Fig. 2-15 shows how the angle which the main lobe makes with the axis of the antenna varies with the antenna length in wavelengths. The angle shown by the solid curve is the maximum point of the lobe; that is, the direction in which the field strength is greatest. The broken curve shows the angle at which the first null (the one that occurs at the smallest angle with the wire) appears. There is also a null in the direction of the wire itself (0 degrees) and so the total width of the main lobe is the angle between the wire and the first null. It can be seen from Fig. 2-15 that the width of the lobe decreases as the wire becomes longer. At 1 wavelength, for example, it has a width of 90 degrees, but at 8 wavelengths the width is slightly less than 30 degrees.

A plane diagram of the radiation pattern of a 1-wavelength harmonic wire is shown in Fig. 2-16. This is a free-space diagram in the plane containing the wire axis (*E* plane), corresponding to the diagrams for the elementary doublet and half-wave dipole shown in Figs. 2-12 and 2-13. It is based on an infinitely thin antenna conductor with ideal current distribution, and in a practical antenna system will be modified by the presence of the earth and other effects that will be considered later.

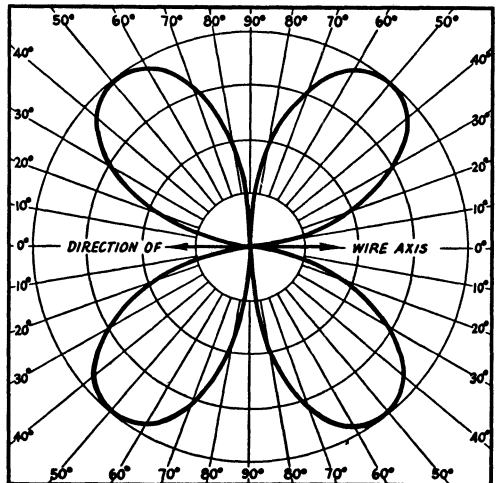

Fig. 2-16 — Free-space directive diagram of a 1-wavelength harmonic antenna in the plane containing the wire axis.

## HOW PATTERNS ARE FORMED

The radiation pattern of the half-wave dipole is found by summing up, at every point on the surface of a sphere with the antenna at its center, the field contributions of all the elementary dipoles that can be imagined to make up the full-size dipole. Antenna systems often are composed of a group of half-wave dipoles arranged in various ways, in which case each half-wave dipole is called an antenna element. An antenna having two or more such dipoles is called a multielement antenna. (A harmonic antenna can be considered to be constructed of a number of such elements connected in series and fed power appropriately, as described earlier, but is not usually classed as a multielement antenna.)

In a multielement antenna system the overall radiation pattern is determined by the way in which the fields at a distant point from the separate antenna elements combine. With two antenna elements, for example, the field strength at a given point depends on the amplitudes and phase relationship of the fields from each antenna. A requirement in working out a radiation pattern is that the field strength be measured or calculated at a *distant* point — distant enough so that, if the elements carry equal currents, the field strength from each is exactly the same even though the size of the antenna system may be such that one antenna element is a little nearer the measuring point than another. On the other hand, this slight difference in distance, even though it may be only a small fraction of a wavelength in many miles, is very important in determining the *phase* relationships between the fields from the various elements.

The principle on which the radiated fields combine to produce the directive pattern, in the case of multielement antennas, is illustrated in the simple example shown in Fig 2-17. In this case it is assumed that there are two antenna elements, each having a circular directive pattern. The two elements therefore could be half-wave dipoles oriented perpendicular to the page (which gives the plane pattern shown in Fig. 2-14). The separation between the two elements is assumed to be a half wavelength and the currents in them are assumed to be equal. Furthermore, the two currents are in phase; that is, they reach their maximum values in the same polarity at the same instant.

Under these conditions the fields from the two antennas will be in the same phase at any point that is equally distant from both antenna elements. At the instant of time selected for the drawing of Fig. 2-17 the solid circles having the upper antenna at their centers represent, let us say, the location of all points at which the field intensity is maximum and has the direction indicated by the arrowheads. The *distance* between each pair of concentric solid circles, measured along a radius, is equal to one wavelength because, as described earlier in this chapter, it is only at intervals of this distance that the fields are in phase. The broken circle locates the points at which the field intensity is the same as in the case of the solid circles, but is *oppositely* directed. It is therefore 180 degrees out of phase

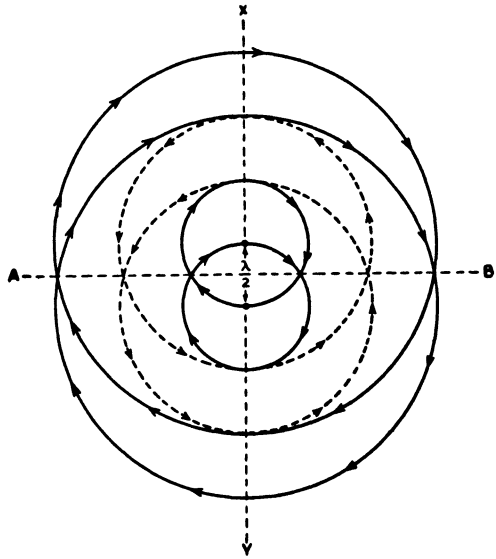

Fig. 2-17 — Interference between waves from two separated radiators causes the resultant directional effects to differ from those of either radiator alone. The two radiators shown here are separated one-half wavelength. The radiation fields of the two cancel along the line *XY* but, at distances which are large compared with the separation between the radiators, add together along line *AB*. The resultant field decreases uniformly as the line is swung through intermediate positions from *AB* to *XY*.

with the field denoted by the solid circles, and the distance between the solid and broken circles is therefore one-half wavelength.

Similarly, the solid circles centered on the lower antenna locate all points at which the field intensity from that antenna is maximum and has the same direction as the solid circles about the upper antenna. In other words, these circles represent points in the same phase as the solid circles around the upper antenna. The broken circle having the lower antenna at its center likewise locates the points of opposite phase.

Considering now the fields from both antennas, it can be seen that along the line *AB* the fields from the two always are exactly in phase, because every point along *AB* is equally distant from both antenna elements. However, along the line *XY* the field from one antenna always is *out* of phase with the other, because every point along *XY* is a half wavelength nearer one element than the other. It takes one-half cycle longer, therefore, for the field from the more distant element to reach the same point as the field from the nearer antenna, and thus the one field arrives 180 degrees out of phase with the other. Since we have assumed that the points considered are sufficiently distant so that the amplitudes of the fields from the two antennas are the same, the *resultant* field at any point along *XY* is zero and the antenna combina-

tion shown will have a null in that direction. However, the two fields add together along  $AB$  and the field strength in that direction will be twice the amplitude of the field from either antenna alone.

The drawing of Fig. 2-17 is not quite accurate because it cannot be made large enough. Actually, the two fields along  $AB$  do not have exactly the same direction until the distance to the measuring point is large enough, compared with the dimensions of the antenna system, so that the waves become plane. In a drawing of limited size the waves are necessarily represented as circles — that is, as representations of a *spherical wave*. The reader, therefore, should imagine Fig. 2-17 as being so much enlarged that the circles crossing  $AB$  are substantially straight lines in the region under discussion.

**Pattern Construction**

The drawing of Fig. 2-17 does not tell us much about what happens to the field strength at points that do not lie on either  $AB$  or  $XY$  although we could make the reasonable guess that the field strength at intermediate points probably would decrease as the point was moved along the arc of a circle farther away from  $AB$  and nearer to  $XY$ . To construct an actual pattern it is necessary to use a different method. It is simple in principle and can be done with a ruler, protractor and pencil, or by trigonometry.

In Fig. 2-18 the two antennas,  $A$  and  $B$ , are assumed to have circular radiation patterns, and to carry equal currents in the same phase. (In other words, the conditions are the same as in Fig. 2-17.) The relative field strength at a distant point  $P$  is to be determined. Here again the limitations of the

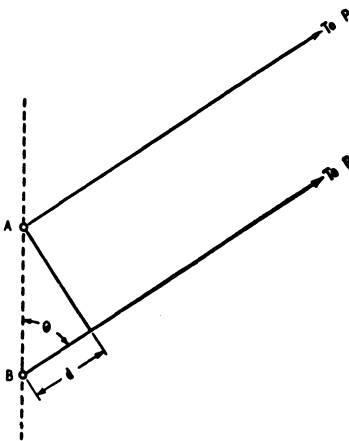

Fig. 2-18 — Graphical construction to determine the relative phase, at a distant point, of waves originating at two antennas,  $A$  and  $B$ . The phase is determined by the additional distance,  $d$ , that the wave from  $B$  has to travel to reach the distant point. This distance will vary with the angle that the direction to  $P$  makes with the axis of the antenna system,  $\theta$ .

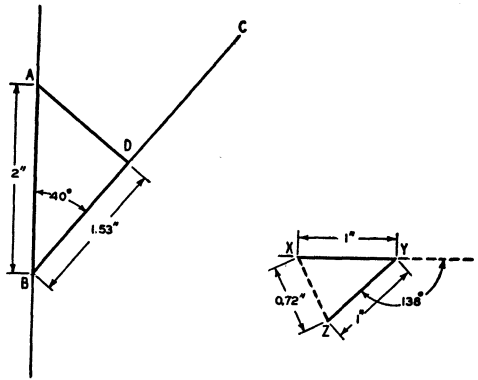

Fig. 2-19 — Graphical construction in the example discussed in the text.

printed page make it necessary to use the imagination, because we assume that  $P$  is far enough from  $A$  and  $B$  so that the lines  $AP$  and  $BP$  are, for all practical purposes, parallel. When this is so, the distance  $d$ , between  $B$  and a perpendicular dropped to  $BP$  from  $A$ , will be equal to the difference in length between the distance from  $A$  to  $P$  and the distance from  $B$  to  $P$ . The distance  $d$  thus measures the difference in the distance the waves from  $A$  and  $B$  have to cover to reach  $P$ ;  $d$  is also, therefore, a measure of the difference in the time of arrival or *phase* of the waves at  $P$ .

Under the assumed conditions, the relative field strengths easily can be combined graphically. The phase angle in degrees between the two fields at  $P$  is equal to

$$\frac{d}{\lambda} \times 360$$

where  $\lambda$  is the wavelength and  $d$  is found by constructing a figure similar to that shown in Fig. 2-18 for  $P$  in any desired direction. The angle  $\theta$  is the angle between a line to  $P$  and the line drawn between the two antenna elements, and is used simply to identify the direction of  $P$  from the antenna system;  $\lambda$  and  $d$  must be expressed in the same length units.

For example, let us assume that  $\theta$  is 40 degrees. We then arbitrarily choose a scale such that four inches is equal to one wavelength — a scale large enough for reasonable accuracy but not too large to be unwieldy. Since the two antenna elements are assumed to be a half-wavelength apart, we start the drawing by placing two points two inches apart and connecting them by a line, as shown in Fig. 2-19. Then, using  $B$  as a center and employing the protractor, we lay off an angle of 40 degrees and draw the line  $BC$ . The next step is to drop a perpendicular from  $A$  to  $BC$ ; this may be done with the 90-degree mark on the protractor but the corner of an ordinary sheet of paper will do just about as well. The distance  $BD$  is then measured, preferably with a ruler graduated in tenths of inches rather than the more usual eighths. By



actual measurement distance  $BD$  is found to be 1.53 inches. The phase difference is therefore  $d/\lambda \times 360 = 1.53/4 \times 360 = 138$  degrees.

The relative field strength in the direction given by  $\theta$  (40 degrees in this example) is found by arbitrarily selecting a line length to represent the strength of the field from each antenna, and then combining them "vectorially." One inch is a convenient length to select.  $XY$ , Fig. 2-19, is such a line, representing the strength of the field from antenna element  $A$ . We then measure off an angle of 138 degrees from  $XY$ , using  $Y$  as a center, and draw  $YZ$  one inch long to represent the strength and phase of the field from antenna element  $B$ . The angle is measured off clockwise from  $XY$  because the field from  $B$  lags behind that from  $A$ . The distance from  $X$  to  $Z$  then represents the relative field strength resulting from the combination of the separate fields from the two antennas, and measurement shows it to be approximately 0.72 inch. In the direction  $\theta$ , therefore, the field strength is 72% as great as the field from either antenna alone. Using trigonometry, the determination may be made by using the equation,

$$\text{Field strength} = 2 \cos \left( \frac{S}{2} \cos \theta \right)$$

where  $S$  = spacing between elements in electrical degrees.

By selecting different values for  $\theta$  and proceeding as above in each case, the complete pattern can be determined. When  $\theta$  is 90 degrees, the phase difference is zero and  $YZ$  and  $XY$  are simply end-to-end along the same line. The maximum field strength is therefore twice that of either antenna alone. When  $\theta$  is zero,  $YZ$  lies on top of  $XY$  (phase difference 180 degrees) and the distance  $XZ$  is therefore zero; in other words the radiation from  $B$  cancels that from  $A$  at such an angle.

The patterns of more complex antenna systems can readily be worked out by this method, although more labor is required if the number of elements is increased. But whether or not actual patterns are worked out, an understanding of the method will do much to make it plain why certain combinations of antenna elements result in specific directive patterns.

The illustration above is a very simple case, but it is only a short step to systems in which the antenna elements do not carry equal currents or currents in the same phase. A difference in current amplitude is easily handled by making the lengths of lines  $XY$  and  $YZ$  proportional to the current in the respective elements; if the current in  $B$  is one half that in  $A$ , for example,  $YZ$  would be drawn one half as long as  $XY$ . If  $B$ 's current leads the current in  $A$  by 25 degrees, then after the angle determined by the distance  $d$  is found the line  $YZ$  is simply rotated 25 degrees in the *counterclockwise* direction before measuring the distance  $XZ$ . The rotation would be *clockwise* for any line representing a lagging current. The lead or lag of current always has to be referred to the current in *one* element of the system, but any desired element can be chosen as the reference.

For two elements fed out of phase but having equal currents, the relationship

$$\text{Field strength} = 2 \cos \left( \frac{a}{2} - \frac{S}{2} \cos \theta \right)$$

may be used, where  $a$  is the phase difference between the two fed elements. Simple trigonometric equations are insufficient for determining array patterns when the currents in the elements are unequal or when there are more than two elements.

It should be noted that the simple methods described above for determining pattern shapes do not take mutual coupling between elements into account, i.e., the fact that current flowing in one element will induce a voltage and therefore a resultant current into the other, and vice versa. When mutual coupling is taken into account the shape of the pattern remains the same for a given condition of element spacing and phasing, but the magnitudes of the resultant vectors used in plotting points for various values of  $\theta$  are altered by a fixed factor. The "fixed" factor will vary with changes in spacing and phasing of the elements. Therefore, a *direct* comparison of the *sizes* of different patterns obtained by these simple procedures cannot be used for determining, say, the gain of one antenna system over another, even though both patterns were derived by using the same scale. Mutual coupling is covered in more detail in Chapter Four.

## DIRECTIVITY AND GAIN

It has been stated that all antennas, even the simplest types, exhibit directive effects in that the intensity of radiation is not the same in all directions from the antenna. This property of radiating more strongly in some directions than in others is called the **directivity** of the antenna. It can be expressed quantitatively by comparing the solid pattern of the antenna under consideration with the solid pattern of the isotropic antenna. The field strength (and thus power per unit area or "power density") will be the same everywhere on the surface of an imaginary sphere having a radius of many wavelengths and having an isotropic antenna at its center. At the surface of the same imaginary sphere around an actual antenna radiating the same total power, the directive pattern will result in greater power density at some points and less at others. The ratio of the maximum power density to the average power density taken over the entire sphere (the latter is the same as from the isotropic antenna under the specified conditions) is the numerical measure of the directivity of the antenna. That is,

$$D = \frac{P}{P_{av}}$$

where  $D$  is the directivity,  $P$  is the power density at its maximum point on the surface of the sphere, and  $P_{av}$  is the average power density.

### Gain

The gain of an antenna is closely related to its directivity. Since directivity is based solely on the *shape* of the directive pattern, it does not take into account any power losses that may occur in an actual antenna system. In order to determine gain these losses must be subtracted from the power supplied to the antenna. The loss is normally a constant percentage of the power input, so the antenna gain is

$$G = k \frac{P}{P_{av}}$$

where  $G$  is the gain expressed as a power ratio,  $k$  is the efficiency (power radiated divided by power input) of the antenna, and  $P$  and  $P_{av}$  are as above. For many of the antenna systems used by amateurs

the efficiency is quite high (the loss amounts only to a few percent of the total), and in such cases the gain is essentially equal to the directivity.

The more the directive diagram is compressed — or, in common terminology, the “sharper” the lobes — the greater the power gain of the antenna. This is a natural consequence of the fact that as power is taken away from a larger and larger portion of the sphere surrounding the radiator it is added to the smaller and smaller volume represented by the lobes. The power is therefore concentrated in some directions at the expense of others. In a general way, the smaller the volume of the solid radiation pattern, compared with the volume of a sphere having the same radius as the length of the largest lobe in the actual pattern, the greater the power gain.

Gain referred to an isotropic radiator is necessarily theoretical; that is, it has to be calculated

TABLE 2-1

#### Power Ratio to Decibel Conversion

Ratio	Decimal Increments									
	.0	.1	.2	.3	.4	.5	.6	.7	.8	.9
1	0.00	0.41	0.79	1.14	1.46	1.76	2.04	2.30	2.55	2.79
2	3.01	3.22	3.42	3.62	3.80	3.98	4.15	4.31	4.47	4.62
3	4.77	4.91	5.05	5.19	5.32	5.44	4.56	5.68	5.80	5.91
4	6.02	6.13	6.23	6.34	6.44	6.53	6.63	6.72	6.81	6.90
5	6.99	7.08	7.16	7.24	7.32	7.40	7.48	7.56	7.63	7.71
6	7.78	7.85	7.92	7.99	8.06	8.13	8.20	8.26	8.33	8.39
7	8.45	8.51	8.57	8.63	8.69	8.75	8.81	8.86	8.92	8.98
8	9.03	9.08	9.14	9.19	9.24	9.29	9.34	9.40	9.44	9.49
9	9.54	9.59	9.64	9.68	9.73	9.78	9.82	9.87	9.91	9.96
10	10.00	10.04	10.09	10.13	10.17	10.21	10.25	10.29	10.33	10.37
x10	+10									
x100	+20									
x1000	+30									
x10,000	+40									
x100,000	+50									

#### Voltage Ratio to Decibel Conversion

Ratio	Decimal Increments									
	.0	.1	.2	.3	.4	.5	.6	.7	.8	.9
1	0.00	0.83	1.58	2.28	2.92	3.52	4.08	4.61	5.11	5.58
2	6.02	6.44	6.85	7.23	7.60	7.96	8.30	8.63	8.94	9.25
3	9.54	9.83	10.10	10.37	10.63	10.88	11.13	11.36	11.60	11.82
4	12.04	12.26	12.46	12.67	12.87	13.06	13.26	13.44	13.62	13.80
5	13.98	14.15	14.32	14.49	14.65	14.81	14.96	15.12	15.27	15.42
6	15.56	15.71	15.85	15.99	16.12	16.26	16.39	16.52	16.65	16.78
7	16.90	17.03	17.15	17.27	17.38	17.50	17.62	17.73	17.84	17.95
8	18.06	18.17	18.28	18.38	18.49	18.59	18.69	18.79	18.89	18.99
9	19.08	19.18	19.28	19.37	19.46	19.55	19.65	19.74	19.82	19.91
10	20.00	20.09	20.17	20.26	20.34	20.42	20.51	20.59	20.67	20.75
x10	+20									
x100	+40									
x1000	+60									
x10,000	+80									
x100,000	+100									

At the top, power ratio to decibel conversion, and at the bottom, voltage ratio to decibel conversion. The decibel value is read from the body of the table for the desired ratio, including decimal increment. For example, a *power* ratio of 2.6 is equivalent to 4.15 dB. A *voltage* ratio of 4.3 (voltages measured across like impedances) is equivalent to 12.67 dB. Values from the table may be extended, as indicated at the lower left in each section. For example, a *power* ratio of 17, which is the same as  $10 \times 1.7$ , is equivalent to  $10 + 2.30 = 12.30$  dB. Similarly, a *power* ratio of 170 ( $100 \times 1.7$ ) =  $20 + 2.30 = 22.30$  dB.

rather than measured because the isotropic radiator has no existence. In practice, measurements on the antenna being tested usually are compared with measurements made on a half-wave dipole. The latter should be at the same height and have the same polarization as the antenna under test, and the reference field – that from the half-wave dipole comparison antenna – should be measured in the most favored direction of the dipole. The data can be secured either by measuring the field strengths produced at the same distance from both antennas when the same power is supplied to each, or by measuring the power required in each antenna to produce the same field strength at the same distance.

A half-wave dipole has a theoretical gain of 2.14 dB over an isotropic radiator. Thus the gain of an actual antenna over a half-wave dipole can be referred to isotropic by adding 2.14 dB to the measured gain, or if the gain is expressed over an isotropic antenna it can be referred to a half-wave dipole by subtracting 2.14 dB.

It should be noted that the field strength (voltage) produced by an antenna at a given point is proportional to the square root of the power. That is, when the two are expressed as ratios (the usual case),

$$\frac{F_1}{F_2} = \sqrt{\frac{P_1}{P_2}}$$

Antenna patterns often are plotted in terms of relative field strength, and if these are to be interpreted in power the field-strength ratio must be squared. For example, if the field strength is doubled, the power ratio is  $2^2$ , or 4.

### The Decibel

As a convenience the power gain of an antenna system is usually expressed in decibels. The decibel is an excellent practical unit for measuring power ratios because it is more closely related to the actual effect produced than the power ratio itself. One decibel represents a just-detectable *change* in signal strength, regardless of the actual value of the signal voltage. A 20-decibel (20-dB) increase in signal, for example, represents 20 observable “steps” in increased signal. The power ratio (100 to 1) corresponding to 20 dB would give an entirely exaggerated idea of the improvement in communication to be expected. The number of decibels corresponding to any power ratio is equal to 10 times the common logarithm of the power ratio, or

$$\text{dB} = 10 \log \frac{P_1}{P_2}$$

If the *voltage* ratio is given, the number of decibels is equal to 20 times the common logarithm of the ratio. That is,

$$\text{dB} = 20 \log \frac{E_1}{E_2}$$

When a voltage ratio is used both voltages must be measured in the same value of impedance. Unless this is done the decibel figure is meaningless, because it is fundamentally a measure of a *power* ratio.

Table 2-1 shows the number of decibels corresponding to various power and voltage ratios. One advantage of the decibel is that successive power gains expressed in decibels may simply be added together. Thus a gain of 3 dB followed by a gain of 6 dB gives a total gain of 9 dB. In ordinary power ratios, the ratios would have to be multiplied together to find the total gain. Furthermore, a *reduction* in power is handled simply by subtracting the requisite number of decibels. Thus reducing the power to 1/2 is the same as *subtracting* 3 decibels. We might, for example, have a power gain of 4 in one part of a system and a reduction of 1/2 in another part, so that the total power gain is  $4 \times 1/2 = 2$ . In decibels, this would be  $6 - 3 = 3$  dB. A power reduction or “loss” is simply indicated by putting a negative sign in front of the appropriate number of decibels.

### Power Gains of Harmonic Antennas

In splitting off into a series of lobes, the solid radiation pattern of a harmonic antenna is compressed into a smaller volume as compared with the single-lobed pattern of the half-wave dipole. This means that there is a concentration of power in certain directions with a harmonic antenna, particularly in the main lobe. The result is that a harmonic antenna will produce an increase in field strength, in its most favored direction, over a half-wave dipole in *its* most favored direction, when both antennas are supplied with the same amount of power.

The power gain from harmonic operation is small when the antenna is small in terms of wavelengths, but is quite appreciable when the antenna is fairly long. The theoretical power gain of harmonic antennas or “long wires” is shown by curve B in Fig. 2-20, using the half-wave dipole as a base. A 1-wavelength or “second harmonic” antenna has only a slight power gain, but an antenna 9 wavelengths long will show a power increase of 5 times over the dipole. This gain is secured in one direction by reducing or eliminating the power radiated in other directions; thus the longer the wire the more directive the antenna becomes.

Curve A in Fig. 2-20 shows how the radiation resistance, as measured at a current loop, varies with the length of a harmonic antenna.

## GROUND EFFECTS

### REFLECTION FROM THE GROUND

The performance of an antenna, particularly with respect to its directive properties, is considerably modified by the presence of the earth underneath it. The earth acts like a huge reflector for

those waves that are radiated from the antenna at angles lower than the horizon. These downcoming waves strike the surface and are reflected by a process very similar to that by which light waves are reflected from a mirror. As in the case of light waves, the angle of reflection is the same as the

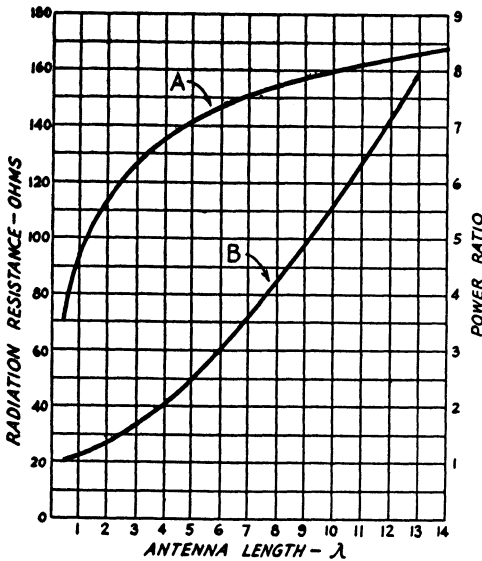

Fig. 2-20 — The variation in radiation resistance and power in the major lobe of long-wire antennas. Curve A shows the change in radiation resistance with antenna length, as measured at a current loop, while Curve B shows the power in the lobes of maximum radiation for long-wire antennas as a ratio to the maximum of a half-wave antenna.

angle of incidence, so that a wave striking the surface at an angle of, for instance, 15 degrees, is reflected upward from the surface at the same angle.

The reflected waves combine with the direct waves (those radiated at angles above the horizontal) in various ways, depending upon the orientation of the antenna with respect to earth, the height of the antenna, its length, and the characteristics of the ground. At some vertical angles above the horizontal the direct and reflected waves may be exactly in phase — that is, the maximum field strengths of both waves are reached at the same time at the same spot, and the directions of the fields are the same. In such a case the resultant field strength is simply equal to the sum of the two. At other vertical angles the two waves may be completely out of phase — that is, the fields are maximum at the same instant and the directions are opposite, at the same spot. The resultant field strength in that case is the *difference* between the two. At still other angles the resultant field will have intermediate values. Thus the effect of the ground is to increase the intensity of radiation at some vertical angles and to decrease it at others.

The effect of reflection from the ground is shown graphically in Fig. 2-21. At a sufficiently large distance, two rays converging at the distant point can be considered to be parallel. However, the reflected ray travels a greater distance in reaching *P* than the direct ray does, and this difference in path length accounts for the effect described in the preceding paragraph. If the ground

were a perfect conductor for electric currents, reflection would take place without a change in phase when the waves are vertically polarized. Under similar conditions there would be a complete reversal (180 degrees) of phase when a horizontally polarized wave is reflected. The actual earth is, of course, not a perfect conductor, but is usually assumed to be one for purposes of calculating the vertical pattern of an antenna. The error is small except at very low vertical angles.

As an example, when the path of the reflected ray is exactly a half wave longer than the path of the direct ray, the two waves will arrive out of phase if the polarization is vertical. This corresponds to the condition illustrated in Fig. 2-17 along the line *XY*. However, if the path of the reflected ray is just a wavelength longer than that of the direct ray, the two rays arrive in phase.

### Image Antennas

It is often convenient to use the concept of an image antenna to show the effect of reflection. As Fig. 2-21 shows, the reflected ray has the same path length (*AD* equals *BD*) that it would if it originated at a second antenna of the same

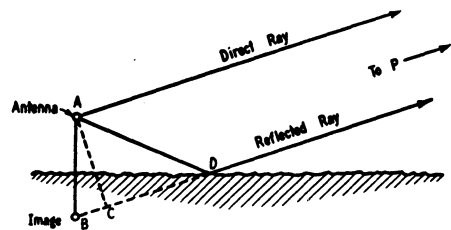

Fig. 2-21 — At any distant point, *P*, the field strength will be the resultant of two rays, one direct from the antenna, the other reflected from the ground. The reflected ray travels farther than the direct ray by the distance *BC*, where the reflected ray is considered to originate at the "image" antenna.

characteristics as the real antenna, but situated below the ground just as far as the actual antenna is above it. Like an image in a mirror, this image antenna is "in reverse," as shown in Fig. 2-22.

If the real antenna is horizontal, and is instantaneously charged so that one end is positive and the other negative, then the image antenna, also horizontal, is oppositely poled; the end under the positively charged end of the real antenna is negative, and vice versa. Likewise, if the lower end of a half-wave vertical antenna is instantaneously positive, the end of the vertical image antenna nearest the surface is negative. Now if we look at the antenna and its image from a remote point on the surface of the ground, it will be obvious that the currents in the horizontal antenna and its image are flowing in opposite directions, or are 180 degrees out of phase, but the currents in the vertical antenna and its image are flowing in the *same* direction, or are *in* phase. The effect of

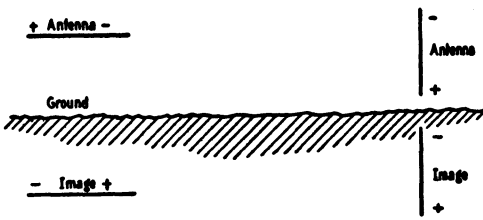

Fig. 2-22 — Horizontal and vertical half-wave antennas and their images.

ground reflection, or the image antenna, is therefore different for horizontal and vertical half-wave antennas. The physical reason for this difference is the fact that vertically polarized waves are reflected from a perfectly conducting earth with no change in phase, but that horizontally polarized waves have their phase shifted by 180 degrees on reflection.

By using techniques similar to those discussed earlier for determining patterns of antennas containing more than one element, it is possible to derive the vertical pattern which will result from an antenna and its image beneath the surface of the earth. The resultant pattern is a modification of the free-space pattern of the antenna. Fig. 2-23 shows how such modification takes place for a horizontal half-wave antenna. The patterns at the left show the relative radiation when one views the antenna from the side; those at the right show the radiation pattern when one looks at the end of the antenna. Changing the height from one-fourth to one-half wavelength makes quite a difference in the upward radiation — that is, the radiation at high angles. (The radiation angle or wave angle is measured from the ground up.)

Reflection Factor

The effect of reflection can be expressed as a factor which, when multiplied by the free-space figure for relative intensity of radiation at a given vertical angle from an antenna, gives the resultant relative radiation intensity at that same angle. The limiting conditions are those represented by the direct ray and reflected ray being exactly in phase and exactly out of phase when both, assuming there are no ground losses, have exactly equal amplitudes. Thus the resultant field strength at a distant point may be either twice the field strength from the antenna alone, or zero.

The way in which the reflection factor (based on perfectly conducting ground) varies with antenna height is shown in the series of graphs, Figs. 2-24 to 2-41. Figs. 2-24 to 2-35 apply to horizontal antennas of any length, and to vertical antennas an *even* number of half waves long. Figs. 2-36

to 2-41 apply to vertical antennas an odd number of half waves long. Comparing the two sets, it is seen that the positions of nulls (multiplying factor zero) and maxima (multiplying factor 2) are interchanged for the two sets of conditions.

It must be remembered that these graphs are not plots of vertical patterns of antennas, but represent simply multiplying factors representing the result of reflection from the ground. With the distinction between vertical and horizontal antennas noted, the graphs apply equally well to *all* antennas. Also, it should be understood that they apply at *vertical* angles only. The ground, if of uniform characteristics, makes no distinction between geographical directions — that is, horizontal angles from the antenna — in reflecting waves.

Fig. 2-42 shows the angles at which nulls and maxima occur as a function of the height of the antenna. This chart gives a rough idea of the ground-reflection pattern for heights intermediate to those shown in detail in Figs. 2-24 to 2-41. It also facilitates picking the right height for any desired angle of radiation.

GROUND CHARACTERISTICS

As already explained, the charts of Figs. 2-24 to 2-41 are based on the assumption that the earth is a perfect conductor. The actual ground is far from being “perfect” as a conductor of electricity. Actually, its behavior depends considerably on the transmitted frequency. At low frequencies — through the standard broadcast band, for example — most types of ground do act very much like a good conductor. At these frequencies the waves can penetrate for quite a distance and thus find a

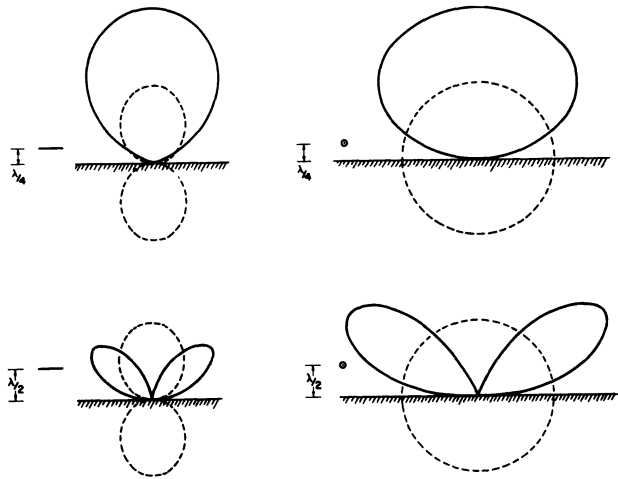

Fig. 2-23 — Effect of the ground on the radiation from a horizontal half-wave antenna, for heights of one-fourth and one-half wavelength. Dashed lines show what the pattern would be if there were no reflection from the ground.

Factors by which the free-space radiation pattern of a horizontal antenna should be multiplied to include the effect of reflection from perfectly conducting ground. These factors affect only the vertical angle of radiation (wave angle).

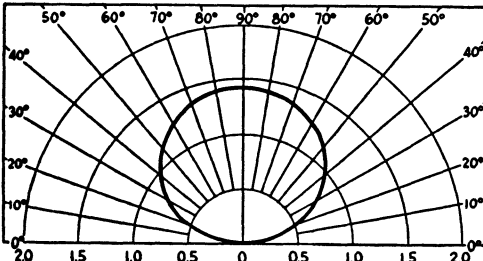

Fig. 2-24 — Horizontal antennas  $1/8$  wavelength high.

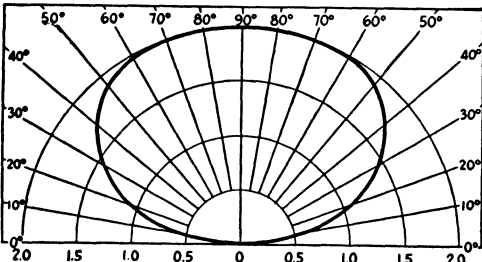

Fig. 2-25 — Horizontal antennas  $1/4$  wavelength high.

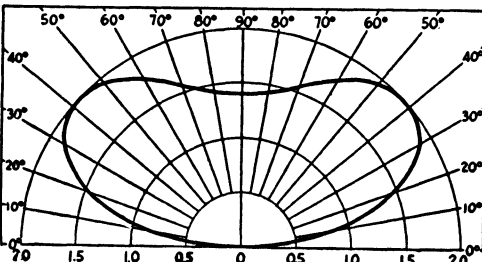

Fig. 2-26 — Horizontal antennas  $3/8$  wavelength high.

large cross section in which to cause current flow along their paths. The resistance of even a moderately good conductor will be low if its cross section is large enough. The ground acts as a fairly good conductor even at frequencies as high as the 3.5-MHz band, and so the charts give a rather good approximation of the effect of the ground at this frequency.

In the higher frequency region the penetration decreases and the ground may even take on the characteristics of a lossy dielectric rather than a good conductor. The chief effect of this change is to absorb most of the energy radiated at the very low angles, in the frequency region from about 7 to 21 MHz. In general, the reflection factor will be lower than given by the charts at angles of less than about 10 degrees, and it is generally considered that the radiation below about 3 degrees is very small compared with the radiation at higher angles. This applies to both vertical and horizontal antennas, so that the "zero-angle" reflection factor with a vertical half-wave antenna, theoretically 2 as

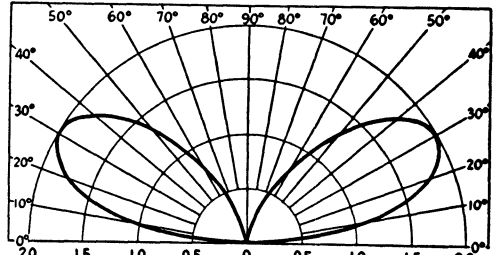

Fig. 2-27 — Horizontal antennas  $1/2$  wavelength high.

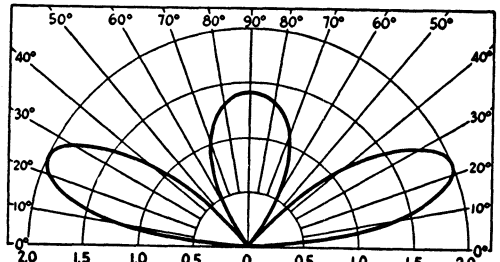

Fig. 2-28 — Horizontal antennas  $5/8$  wavelength high.

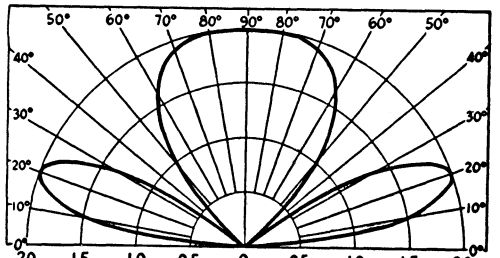

Fig. 2-29 — Horizontal antennas  $3/4$  wavelength high.

shown by the charts, actually is a small fraction. Thus the apparent advantage of the vertical antenna for very low-angle radiation is not realized in practice in this frequency range.

The "effective reflecting plane" of the ground — that is, the surface from which the reflection is considered to take place at the heights given in the charts — seldom coincides with the actual surface of the ground. Usually it will be found that this plane appears to be a few feet below the surface; in other words, the height of the antenna taken for purposes of estimating reflection is a few feet more than the actual height of the antenna. A great deal depends upon the character of the ground, and in some cases the reflecting plane may be "buried" a surprising distance. Thus in some instances the charts will not give an accurate indication of the effect of reflection. On the average, however, they will give a reasonably satisfactory representation of reflection effects, with the qualifications with respect to high frequencies and low angles mentioned above.

Factors by which the free-space radiation pattern of a horizontal antenna should be multiplied to include the effect of reflection from perfectly conducting ground. These factors affect only the vertical angle of radiation (wave angle).

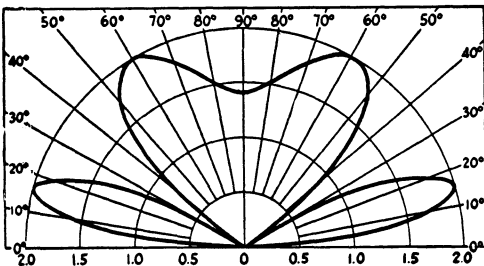

Fig. 2-30 — Horizontal antennas  $7/8$  wavelength high.

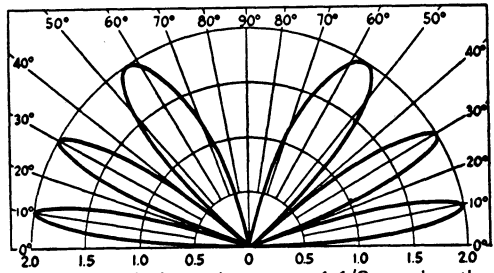

Fig. 2-33 — Horizontal antennas  $1-1/2$  wavelengths high.

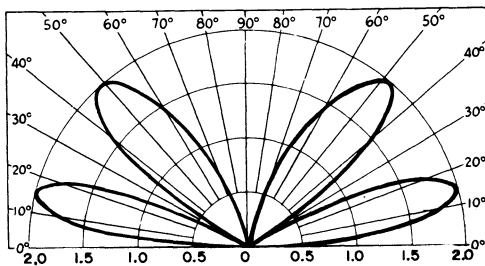

Fig. 2-31 — Horizontal antennas 1 wavelength high.

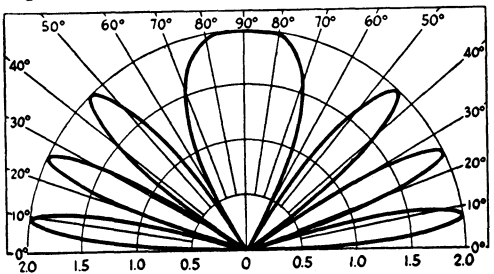

Fig. 2-34 — Horizontal antennas  $1-3/4$  wavelengths high.

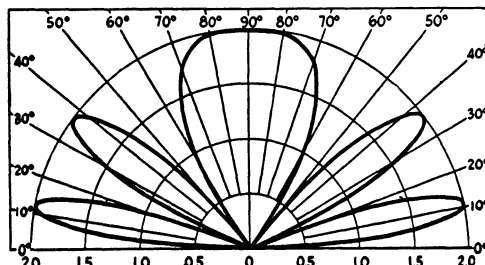

Fig. 2-32 — Horizontal antennas  $1-1/4$  wavelengths high.

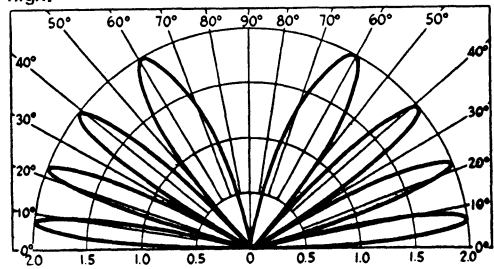

Fig. 2-35 — Horizontal antennas 2 wavelengths high.

In general, the effects of placing the antenna over real earth, rather than a perfect conductor, are to decrease the magnitude of the lobes of the pattern and to fill in the nulls. These effects are shown in Fig. 2-43.

In the vhf and uhf region (starting in the vicinity of the 28-MHz band) a different situation exists. At these frequencies little, if any, use is made of the part of the wave that travels in contact with the ground. The antennas, both transmitting and receiving, usually are rather high in terms of wavelength. The wave that is actually used — at least for line-of-sight communication — is in most cases several wavelengths above the surface of the ground. At such a height there is not consequential loss of energy; the direct ray travels from the transmitter to the receiver with only the normal attenuation caused by spreading, as explained in Chapter One. The loss of energy in the reflected ray is beneficial rather than otherwise, as also explained in that chapter. The net result is that radiation at very low angles is quite practicable in

this frequency region. Also, there is little practical difference between horizontal and vertical polarization.

### GROUND REFLECTION AND RADIATION RESISTANCE

Waves radiated from the antenna directly downward reflect vertically from the ground and, in passing the antenna on their upward journey, induce a current in it. The magnitude and phase of this induced current depends upon the height of the antenna above the reflecting surface.

The total current in the antenna thus consists of two components. The amplitude of the first is determined by the power supplied by the transmitter and the free-space radiation resistance of the antenna. The second component is induced in the antenna by the wave reflected from the ground. The second component, while considerably smaller than the first at most useful antenna heights, is by

no means inappreciable. At some heights the two components will be more or less in phase, so the total current is larger than would be expected from the free-space radiation resistance. At other heights the two components are out of phase, and at such heights the total current is the difference between the two components.

Thus merely changing the height of the antenna above ground will change the amount of current flow, assuming that the power input to the antenna is held constant. A higher current at the same value of power means that the effective resistance of the antenna is lower, and vice versa. In other words, the radiation resistance of the antenna is affected by the height of the antenna above ground. Fig. 2-44 shows the way in which the radiation resistance of a horizontal half-wave antenna varies with height, in terms of wavelengths, over perfectly

conducting ground. Over actual ground the variations will be smaller, and tend to become negligible as the height approaches a half wavelength. The antenna on which this chart is based is assumed to have an infinitely thin conductor, and thus has a somewhat higher free-space value of radiation resistance (73 ohms) than an antenna constructed of wire or tubing. (See Fig. 2-7.)

**Ground Screens**

The effect of a perfectly conducting ground can be simulated, under the antenna, by installing a metal screen or mesh (such as chicken wire) near or on the surface of the ground. The screen preferably should extend at least a half wavelength in every direction from the antenna. Such a screen will rather effectively establish the height of the anten-

Factors by which the free-space radiation pattern of a half-wave vertical antenna should be multiplied to include the effect of reflection from perfectly conducting ground. These factors affect only the vertical angle of radiation (wave angle).

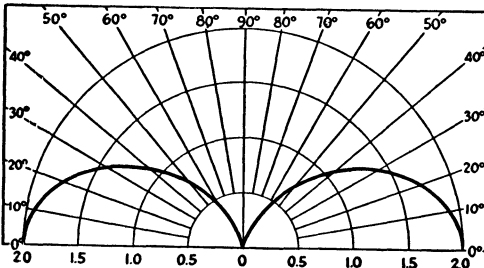

Fig. 2-36 – Vertical dipole antenna with center 1/4 wavelength high.

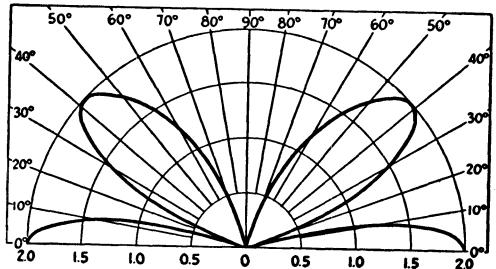

Fig. 2-39 – Vertical dipole antenna with center 3/4 wavelength high.

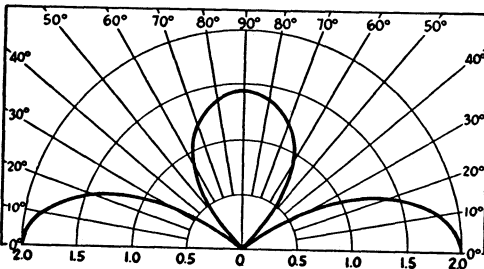

Fig. 2-37 – Vertical dipole antenna with center 3/8 wavelength high.

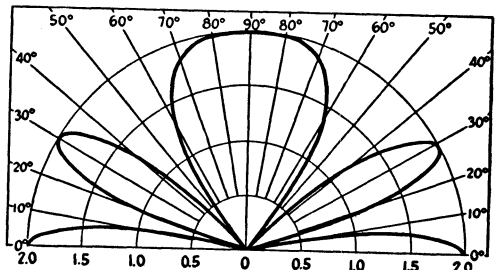

Fig. 2-40 – Vertical dipole antenna with center 1 wavelength high.

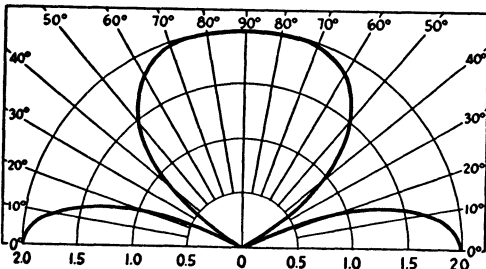

Fig. 2-38 – Vertical dipole antenna with center 1/2 wavelength high.

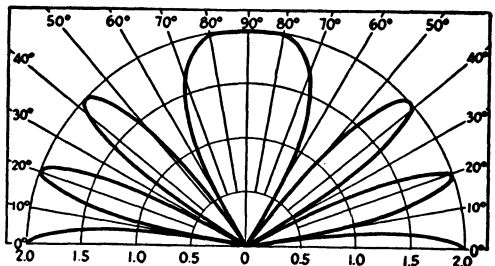

Fig. 2-41 – Vertical dipole antenna with center 1-1/2 wavelengths high.



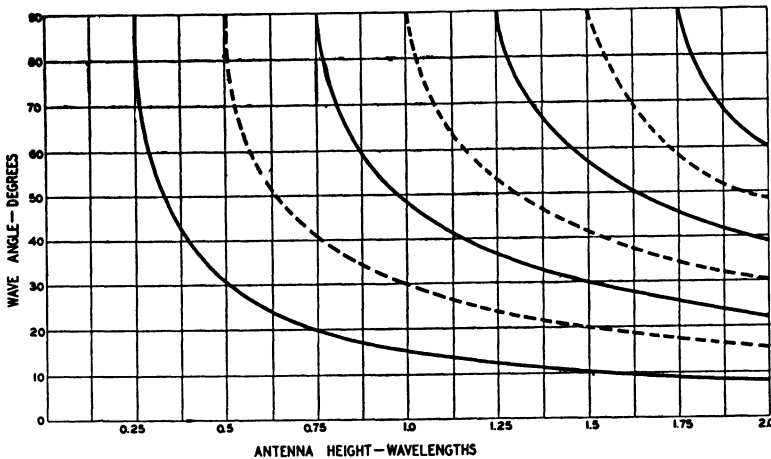

Fig. 2-42 — Angles at which nulls and maxima (factor = 2) in the ground-reflection factor appear for antenna heights up to two wavelengths. The solid lines are maxima, dashed lines nulls, for all horizontal antennas and for vertical antennas having a length equal to an even multiple of one-half wavelength. For vertical antennas an odd number of half waves long, the dashed lines are maxima and the solid lines nulls. For example, if it is desired to have the ground reflection give maximum reinforcement of the direct ray from a horizontal antenna at a 20-degree wave angle (angle of radiation) the antenna height should be 0.75 wavelength. The same height will give a null at 42 degrees and a second maximum at 90 degrees. Values may also be determined from the trigonometric relationship  $\theta = \arcsin(A/4h)$ , where  $\theta$  is the wave angle and  $h$  is the antenna height expressed in wavelengths. For the first maxima (horizontal antennas),  $A$  has a value of 1; for the first null  $A$  has a value of 2, for the second maxima 3, for the second null 4, and so on.

na insofar as radiation resistance is concerned, since it substitutes for the actual earth underneath the antenna.

For vertical quarter-wave antennas the screen also reduces losses in the ground near the antenna, since if the screen conductors are solidly bonded to each other the resistance is much lower than the resistance of the ground itself. With other types of antennas — e.g., horizontal — at heights of a

quarter wavelength or more, losses in the ground are much less important. For these types the considerable constructional problems are not justified by the possible improvement.

Ground screens will affect only the very high-angle rays from horizontal antennas, and will not appreciably modify the effect of the earth itself at the lower radiation angles which ordinarily are used for long-distance communication.

## DIRECTIVE DIAGRAMS AND THE WAVE ANGLE

In the discussion of radiation patterns or directive diagrams of antennas it was brought out that such patterns always are three-dimensional affairs, but that it is difficult to show, on a plane sheet of paper, more than a cross section of the solid pattern at a time. The cross sections usually selected are those cut by a plane that contains the wire axis, and those cut by a plane perpendicular to the wire axis.

If the antenna is horizontal, the former pattern (the cross section cut by a plane containing the wire) represents the radiation pattern of the antenna when the wave leaves the antenna (or arrives at it) at zero angle of elevation above the earth. The angle of elevation — the “vertical” angle referred to in the discussion of ground effects — is usually called the wave angle. In the case of the vertical antenna the radiation pattern at zero wave angle is given by the cross section cut by the plane perpendicular to the wire axis. (In the latter case it must be remembered that the antenna itself is

assumed to be merely a point at the center of the pattern, so the plane must pass through this point.)

Now with two exceptions — surface waves at low frequencies and space waves at vhf and higher — the wave angle used for communication is not zero. In ionospheric transmission, waves sent directly *upward* can be reflected back to earth, if the frequency is low enough. On the other hand, as pointed out earlier in this chapter, in most of the frequency range useful for ionospheric communication, waves leaving at an angle of less than about 3 degrees are largely absorbed by ground losses. What we are interested in at these frequencies, then, is the directive pattern of the antenna at a wave angle that is of value in communication.

### EFFECTIVE DIRECTIVE DIAGRAMS

The directive diagram for a wave angle of zero elevation (purely horizontal radiation) does not give an accurate indication of the directive properties of a horizontal antenna at wave angles above

Fig. 2-43 — At A, a typical free-space vertical radiation pattern of a horizontal multielement array, such as a Yagi antenna. The forward direction of the array is to the right. At B, the free-space pattern as modified by placing the antenna one wavelength above a perfect conductor (multiplying factors from Fig. 2-31). Because the earth is not a perfect conductor, a typical measured radiation pattern for a 1-λ-high Yagi will more nearly resemble that shown at C, calculated by assuming that only portions of the energy striking the earth are reflected.

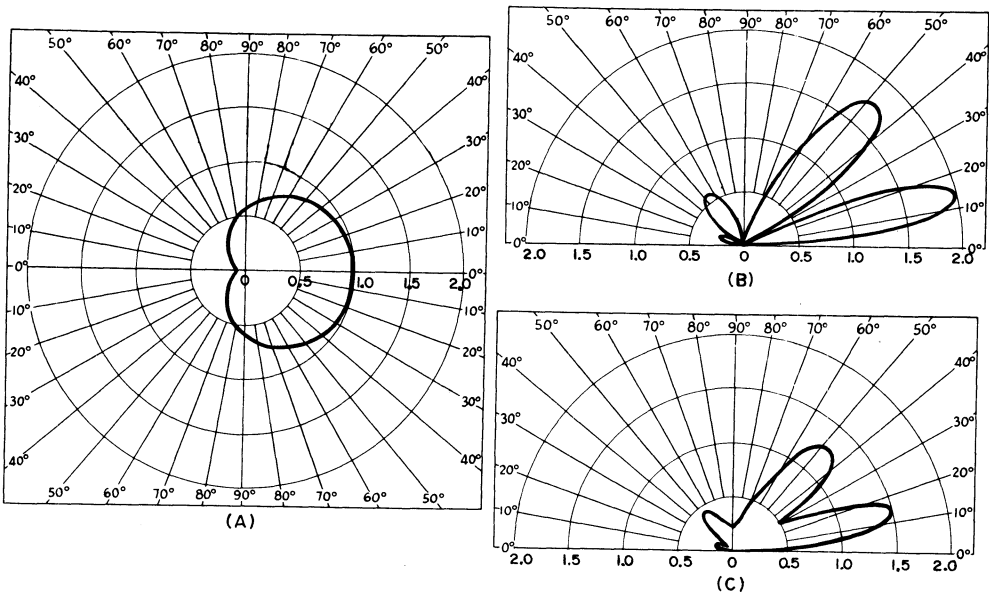

zero. For example, consider the half-wave dipole pattern in Fig. 2-13. It shows that there is no radiation directly in line with the antenna itself, and this is true at zero wave angle. However, if the antenna is horizontal and some wave angle other than zero is considered, it is not true at all.

The reason why will become clear on inspection of Fig. 2-45, which shows a horizontal half-wave

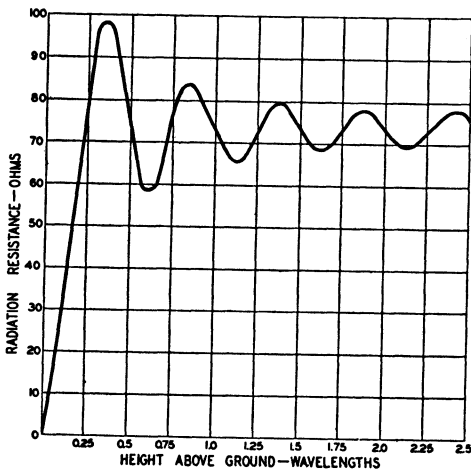
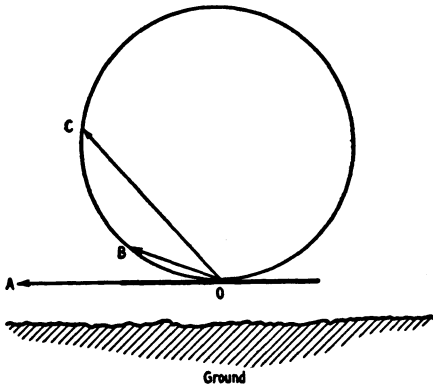

Fig. 2-44 — Variation in radiation resistance of a horizontal half-wave antenna with height above perfectly conducting ground.

antenna with a cross section of its free-space radiation pattern, cut by a plane that is vertical with respect to the earth and which contains the axis of the antenna conductor. In other words, the view is looking broadside at the antenna wire. (For the moment, reflections from the ground are neglected.) The lines *OA*, *OB* and *OC* all point in the same *geographical* direction (the direction in which the wire itself points), but make different angles with the antenna in the vertical plane. In other words, they correspond to different wave angles or angles of radiation, with all three rays aimed along the same line on the earth's surface. So far as compass directions are concerned, *all three waves are leaving the end of the antenna.*

The purely horizontal wave *OA* has zero amplitude, but at a somewhat higher angle corresponding to the line *OB* the field strength is appreciable. At a still higher angle corresponding to the line *OC* the field strength is still greater. In this particular pattern, the higher the wave angle the greater the field strength in the compass direction *OA*. It should be obvious that it is necessary, in plotting a directive diagram that purports to show the behavior of the antenna in different compass directions, to specify the angle of radiation for which the diagram applies. When the antenna is horizontal the shape of the diagram will be altered considerably as the wave angle is changed.

As described in Chapter One, the wave angles that are useful depend on two things — the distance over which communication is to be carried on, and the height of the ionospheric layer that



does the reflecting. Whether the *E* or *F*<sub>2</sub> layer (or a combination of the two) will be used depends on the operating frequency, the time of day, season, and the sunspot cycle. The same half-wave antenna, operating on the same frequency, may be almost nondirectional for distances of a few hundred miles but will give substantially better results broadside than off its ends at distances of the order of 1000-1200 miles during the day when transmission is by the *E* layer. In the evening, when the *F* layer takes over, the directivity may be fairly well marked at long distances and not at all pronounced at 1000 miles or less. From this it might seem that it would be impossible to predict the directivity of an antenna without all sorts of qualifications. However, it is possible to get a very good idea of the directivity by choosing a few angles that, on the average, are representative for different types of work. With patterns for such angles available it is fairly simple to interpolate for intermediate angles. Combined with some knowledge of the behavior of the ionosphere, a fairly good estimate of the directive characteristics of a particular antenna can be made for the particular time of day and distance of interest.

In the directive patterns given in Figs. 2-46 to 2-49, inclusive, the wave angles considered are 9, 15 and 30 degrees. These represent, respectively, the median values of a range of angles that have been found to be effective for communication at 28, 21, 14 and 7 MHz. Because of the variable nature of ionospheric propagation, the patterns should not be considered to be more than general guides to the sort of directivity to be expected.

In the directive patterns of Figs. 2-46 to 2-49, the relative field strength has been plotted in decibels. This makes the patterns more representative of the effect produced than is the case when the relative intensity is plotted in either voltage or power. Since one S unit on the signal-strength scale is roughly 5 or 6 dB, it is easy to get an approximate idea of the operation of the antenna. For example, off the ends of a half-wave antenna the signal can be expected to be "down" between 2 and 3 S units compared with its strength at right angles or broadside to the antenna, at a wave angle of 15 degrees. This would be fairly representative of its performance on 14 MHz at distances of 500 miles or more. With a wave angle of 30 degrees the

Fig. 2-45 — The effective directive pattern of the antenna depends upon the angle of radiation considered. As shown by the arrows, the field strength in a given compass direction will be quite different at different vertical angles.

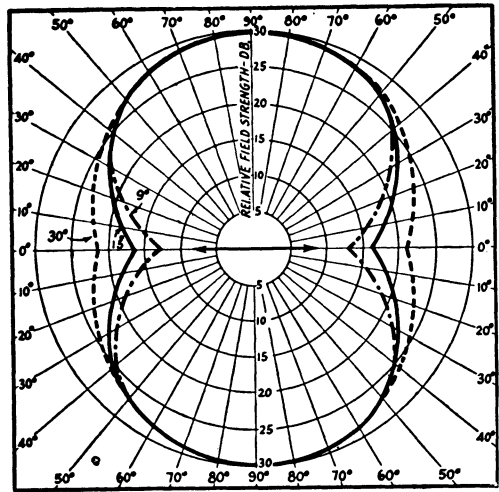

Fig. 2-46 — Directive patterns of a horizontal half-wave antenna at three radiation angles, 9, 15 (solid line), and 30 degrees. The direction of the antenna itself is shown by the arrow. These patterns are plotted to a 30-dB scale, which is about proportional to signal strength as determined by ear. If 30 dB represents an S-9 signal, 0 on the scale will be about S-3. All three patterns are plotted to the same maximum, but the actual amplitudes at the various angles will depend upon the antenna height, as described in the text. The patterns shown here indicate only the shape of the directive diagram as the angle is varied.

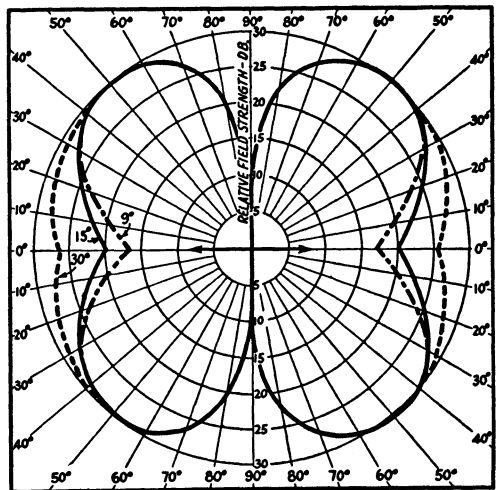

Fig. 2-47 — The horizontal patterns for a one-wavelength antenna at vertical angles of 9, 15 and 30 degrees.

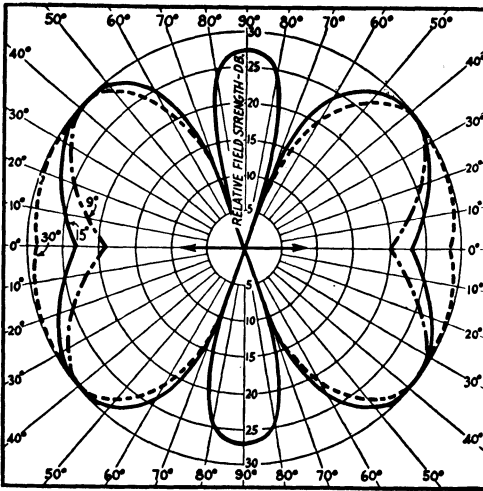

Fig. 2-48 — The horizontal patterns for a 1-1/2-wavelength antenna at vertical angles of 9, 15 and 30 degrees.

signal off the ends would be down only 1 to 2 S units, while at an angle of 9 degrees it would be down 2-1/2 to 3-1/2 S units. Since high wave angles become less useful as the frequency is increased, this illustrates the importance of running the antenna wire in the proper direction if best results are wanted in a particular direction at the higher frequencies.

**Height Above Ground**

The *shapes* of the directive patterns given in Figs. 2-46 to 2-49 are not affected by the height of the antenna above the ground. However, the *amplitude* relationships between the patterns of a given antenna for various wave angles are modified by the height. In the figures as given, the scale is such that the same field intensity is assumed in the direction of maximum radiation, regardless of the wave angle. To make best use of the patterns the effect of the ground-reflection factor should be included.

Take the horizontal half-wave antenna shown in Fig. 2-46 as an example, and assume that the antenna is a half wavelength above perfectly conducting ground. The graph of the ground-reflection factor for this height is given in Fig. 2-27. For angles of 9, 15, and 30 degrees the values of the factor as read from the curve are 1.0, 1.5 and 2.0, respectively. These factors are applied to field strength. For convenience, take the 9-degree angle as a reference. Then at a wave angle of 15 degrees the field strength will be 1.5 times the field strength at 9 degrees, in any compass direction, and at a wave angle of 30 degrees will be 2.0 times the field strength at 9 degrees, in any compass direction. Since the factors apply to field strength (voltage), the ratios just obtained may be converted to decibels by using the voltage section of Table 2-I. A voltage ratio of 1.5 corresponds to 3.5 dB, and a ratio of 2.0 corresponds to 6 dB. Hence at an

angle of 15 degrees the radiation in any direction is 3.5 dB above the radiation at 9 degrees, and at a wave angle of 30 degrees it is 6 dB above. To put it another way, at a wave angle of 30 degrees the antenna is about one S unit better than it is at 9 degrees. There is about a half S-unit difference between 9 and 15 degrees, and between 15 and 30 degrees. If we wished, we could add 3.5 dB to every point on the 15-degree graph in Fig. 2-46, and 6 dB to every point on the 30-degree graph, and thus show graphically the comparison in amplitude as well as shape of the directive pattern at the three angles. This has been done in the graph of Fig. 2-50. However, it is generally unnecessary to take the trouble to draw separate graphs because it is so easy to add or subtract the requisite number of decibels as based on the appropriate ground-reflection factor.

It should be emphasized again that the patterns are based on idealized conditions not realized over actual ground. Nevertheless, they are useful in indicating about what *order* of effect to expect.

**Using the Patterns**

Directive patterns can be of considerable help in solving practical problems in the choice and location of antennas, particularly in cases where a simple type of antenna (such as the antennas discussed in this chapter) must be used. While it is not to be expected that antenna performance will conform to the theoretical with the same exactness that you would expect Ohm's Law calculations to work out, the results averaged over a period of time will be sufficiently close to the predictions to make a little preliminary estimating worthwhile.

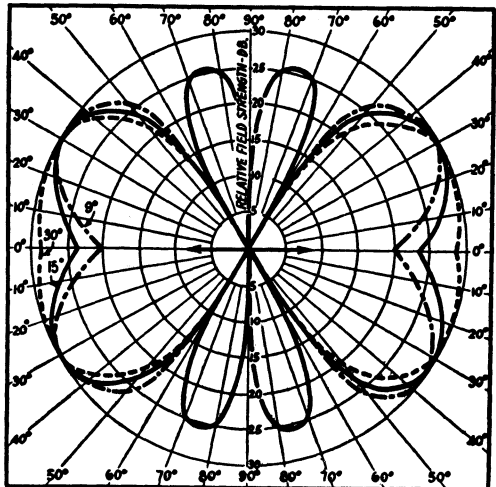

Fig. 2-49 — The horizontal patterns for a 2-wavelength antenna at vertical angles of 9, 15, and 30 degrees. As the antenna length is made still longer the major lobes move closer to the wire, and the number of minor lobes increases. The total number of lobes on each side of the wire is numerically equal to twice the number of wavelengths of the wire.

Here is one example: Suppose that a clear space of about 70 feet is available between two supports that will hold the antenna about 35 feet above ground. The operating frequency is to be 28 MHz, and the position of the supports is such that the antenna will run west of north by 10 degrees. The principal direction of transmission is to be 35 degrees east of north, but there is another area in the general direction 15 degrees south of west that is also hoped to be covered as well as possible. The situation is shown in Fig. 2-51 (in this figure the last direction is shown with reference to the north-south line).

In the available space, it is possible to erect antennas 1/2, 1, 1-1/2 or 2 wavelengths long. Since the supports are at fixed height, the ground-reflection factor will be the same for all the possible antennas and so may be left out of the estimates. The principal direction is 45 degrees off the line of the antenna and the secondary direction is 85 degrees off. For simple antennas such as these the directive patterns are symmetrical about the wire axis and so we do not have to worry about whether the angles lie east or west of the antenna.

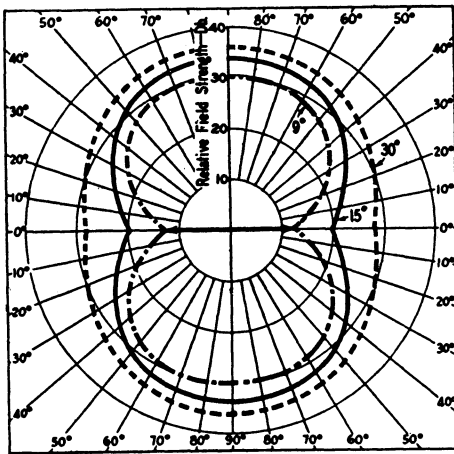

Fig. 2-50 — These diagrams compare the amplitudes of radiation at wave angles of 9, 15 and 30 degrees from a horizontal half-wave antenna when the height is 1/2 wavelength.

Since the frequency is 28 MHz, the 9-degree patterns should be used. From Fig. 2-46 we see that the relative amplitudes at 45 and 85 degrees are 27 and 30 dB, respectively, for the half-wave antenna. From Fig. 2-47 the corresponding amplitudes are 30 and 17 dB; from Fig. 2-48 the amplitudes are 28 and 27 dB; and from Fig. 2-49 the amplitudes are 28 and 20 dB. To these amplitudes we should add the gains realized by harmonic operation as given in Fig. 2-20. These are, for the 1/2-, 1-, 1-1/2- and 2-wavelength antennas, respectively, 1, 1.1, 1.2 and 1.3 in power. Converted to decibels by using Table 2-1 they are 0, 0.4, 0.8 and 1.1 dB respectively. They are small enough to be less important than the probable error in reading the charts, but will be

included for the sake of completeness. Arranging the information in table form gives:

	Antenna Length in Wavelengths			
	0.5	1	1.5	2
Relative intensity at 45 degrees, dB	27	30	28	28
Gain from harmonic operation, dB	0	0.4	0.8	1.1
Total dB	27	30.4	28.8	29.1
Relative intensity at 85 degrees, dB	30	17	27	20
Gain from harmonic operation, dB	0	0.4	0.8	1.1
Total dB	30	17.4	27.8	21.1

It is seen that either a 1-wavelength or 2-wavelength antenna will give the best results in the principal direction, but that neither is as good as a half-wave antenna in the secondary direction. Perhaps an acceptable compromise in results could be obtained with the 1-1/2-wavelength antenna. However, in a case such as this, the best results would be obtained by using two antennas since there is room to string them end to end. A good combination, for example, would be a 1-wavelength and 1/2-wavelength antenna, arranged with a little space between the ends so the coupling between the pair of antennas is substantially reduced.

Another example: Space is available to erect a 2-wavelength antenna at a height of 30 feet, for operation on 28 MHz, and it is possible to orient the antenna so that its major lobe will point in the direction of transmission desired. Alternatively, a self-supporting half-wave dipole could be erected at a height of 45 feet and oriented so that its maximum radiation would be in the desired direction. Which antenna is likely to be the better one?

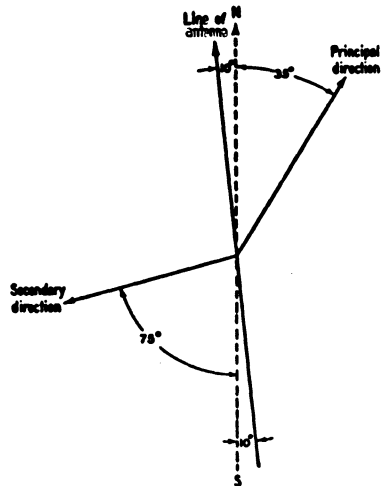

Fig. 2-51 — Example discussed in the text.

From Fig. 2-20, the power gain of a 2-wavelength antenna over a dipole is 1.3, and from Table 2-1 this power ratio corresponds to a gain of 1.1 dB. At 28 MHz the length of one wavelength in air is  $984/28 \approx 35$  feet. At 30 feet the height in wavelengths is  $30/35 = 0.86\lambda$ , and at 45 feet it is  $45/35 = 1.3\lambda$ . (It is not necessary to carry out the calculations to more than two significant figures because the height above the effective ground plane is not known. As explained earlier, the "effective" height would tend to be higher than the actual height.) A height of  $0.86\lambda$  is near enough to  $7/8\lambda$  to permit us to use Fig. 2-30, in which the ground-reflection factor is shown as 1.5 at a wave angle of 9 degrees. From Table 2-1 the corresponding figure is 3.5 dB. A height of  $1.3\lambda$  is slightly over  $1-1/4\lambda$ , and inspecting Figs. 2-32 and 2-33 shows that the reflection factor therefore will lie in the vicinity of 1.9, or about 5.6 dB. Putting these figures into table form, we have:

	Dipole	$2\lambda$ Antenna
Relative intensity of main lobe, dB	30	30
Gain from harmonic operation, dB	0	1.1
Ground-reflection factor, dB	5.6	3.5
<b>Total dB</b>	<b>35.6</b>	<b>34.6</b>

The difference, 1 dB, is in favor of the dipole antenna, but for all practical purposes the two antennas could be considered equally good in the desired direction; the additional height of the dipole overcomes the gain of the harmonic antenna. The choice therefore could be based purely on other considerations such as convenience in erection, the fact that the dipole antenna will be effective over a wider horizontal angle than the harmonic antenna, or perhaps the desire to minimize the effectiveness in unwanted directions.

Once again it must be emphasized that calculations such as these should not be taken *too* literally. Too many factors, particularly the behavior of the ground, are unknown. The calculations are useful principally as a guide to determining the type of antenna that, in all probability, will best meet the required working conditions.

## RADIATION RESISTANCE AND GAIN

The field strength produced at a distant point by a given antenna system is directly proportional to the current flowing in the antenna. In turn, the amount of current that will flow, when a fixed amount of power is applied, will be inversely proportional to the square root of the radiation resistance. Lowering the radiation resistance will increase the field strength and raising the radiation resistance will decrease it. This is not to be interpreted broadly as meaning that a low value of radiation resistance is good and a high value is bad, regardless of circumstances, because that is far

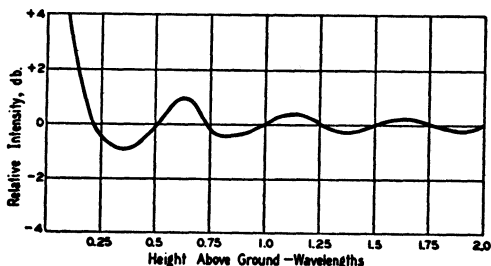

Fig. 2-52 — Gain or loss in decibels because of change in antenna current with radiation resistance, for fixed power input. Perfectly conducting ground is assumed.

from the actual case. What it means is that with an antenna of given dimensions, a change that reduces the radiation resistance *in the right way* will be accompanied by a change in the directive pattern that in turn will increase the field strength in some directions at the expense of reduced field strength in other directions. This principle is used in certain types of directive systems described in detail in Chapter Four.

The shape of the directional pattern in the vertical plane is, as previously described, modified by the height of the antenna above ground. The effect of height on radiation resistance has been shown in Fig. 2-44 for the horizontal half-wave dipole. The plots of ground-reflection factors shown in Figs. 2-24 to 2-35, inclusive, show the actual shape of the pattern of such a half-wave dipole in the vertical plane at right angles to the wire. That is, they show the variation in intensity with wave angle in the direction broadside to the antenna. In an approximate way, the radiation resistance is smaller as the area of the pattern is less, as can be seen by comparing the ground reflection patterns with the curve of Fig. 2-44.

Varying the height of a horizontal half-wave antenna while the power input is held constant will cause the current in the antenna to vary as its radiation resistance changes. Under the idealized conditions represented in Fig. 2-44 (an infinitely thin conductor over perfectly conducting ground) the field intensity at the optimum wave angle for

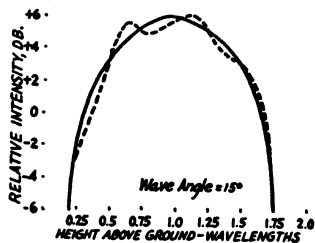

Fig. 2-53 — Solid curve, relative intensity vs. height at a wave angle of 15 degrees, because of reflection from perfect ground. Broken curve, height and effect of change in radiation resistance (Fig. 2-52) combined.

each height will vary as shown in Fig. 2-52. In this figure the relative field intensity is expressed in decibels, using the field when the radiation resistance is 73 ohms as a reference (0 dB). From this cause alone, there is a gain of about 1 dB when the antenna height is  $5/8$  wavelength as compared with either  $1/2$  or  $3/4$  wavelength.

The gain or loss from the change in radiation resistance should be combined with the reflection factor for the particular wave angle and antenna height considered, in judging the overall effect of height on performance. For example, Fig. 2-53 shows the reflection factor, plotted in decibels, for a wave angle of 15 degrees (solid curve). This curve is based on data from Figs. 2-24 to 2-35, inclusive. Taken alone, it would indicate that a height of slightly less than 1 wavelength is optimum for this wave angle. However, when the values taken from the curve of Fig. 2-52 are added, the broken curve results. Because of the change in radiation resistance, there is a maximum near a height of  $5/8$

wavelength that is very nearly as good as the next maximum at a height of 1 to  $1-1/4$  wavelength. The change in radiation resistance also has the effect of steepening the curve at the lower heights and flattening it in the optimum region. Thus it would be expected that, for this wave angle, increasing the height of a half-wave dipole is very much worthwhile up to about  $5/8$  wavelength, but that further increases would not result in any material improvement. At 14 MHz, where a 15-degree wave angle is taken to be average,  $5/8$  wavelength is about 45 feet.

There is, of course, some difficulty in applying the information obtained in this fashion because of the uncertainty as to just where the ground plane is. One possibility, if the antenna can be raised and lowered conveniently, is to measure the current in it while changing its height, keeping the power input constant. Starting with low heights, the current should first go through a minimum (at a theoretical height of about  $3/8$  wavelength) and

Vertical-plane radiation patterns of horizontal half-wave antennas above perfectly conducting ground.

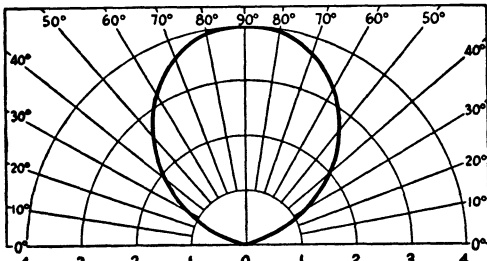

Fig. 2-54 — In direction of wire; height  $1/4$  wavelength.

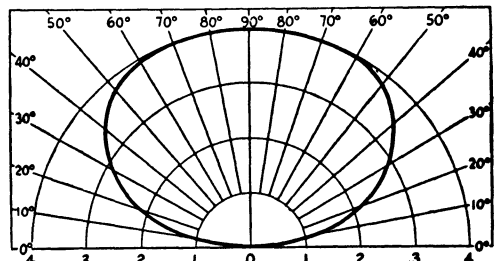

Fig. 2-55 — At right angles to wire; height  $1/4$  wavelength.

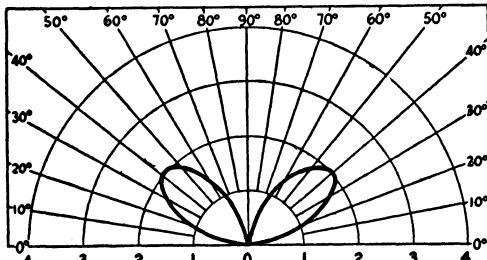

Fig. 2-56 — In direction of wire; height  $1/2$  wavelength.

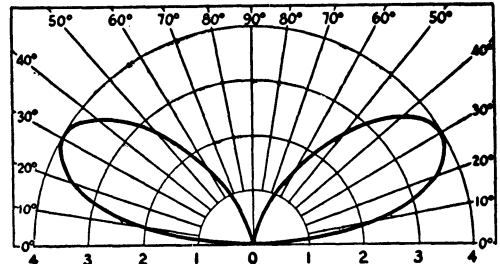

Fig. 2-57 — At right angles to wire; height  $1/2$  wavelength.

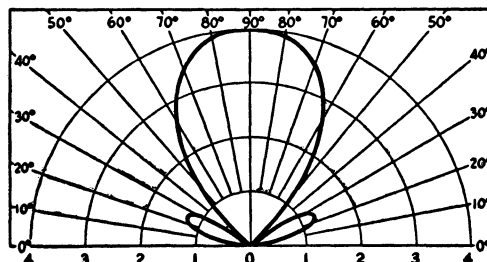

Fig. 2-58 — In direction of wire; height  $3/4$  wavelength.

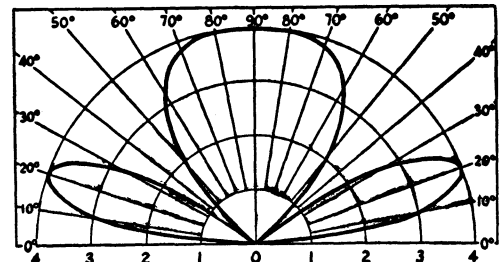

Fig. 2-59 — At right angles to wire; height  $3/4$  wavelength.

Vertical-plane radiation patterns of horizontal half-wave antennas above perfectly conducting ground.

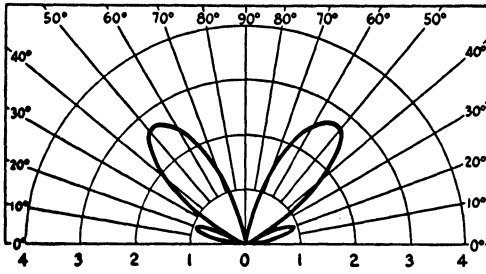

Fig. 2-60 — In direction of wire; height 1 wavelength.

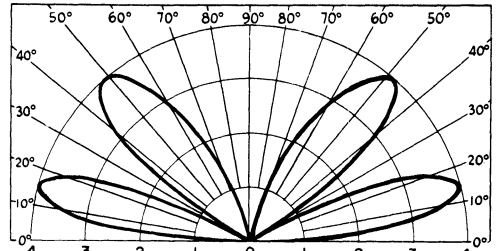

Fig. 2-61 — At right angles to wire; height 1 wavelength.

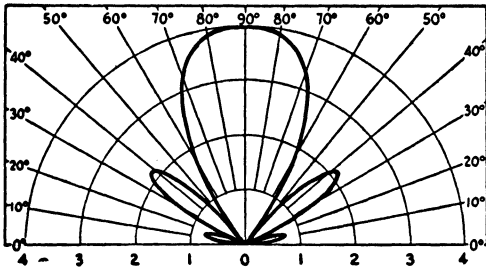

Fig. 2-62 — In direction of wire; height 1-1/4 wavelength.

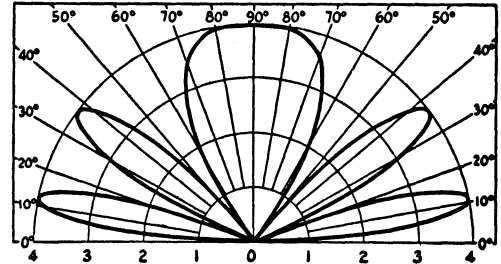

Fig. 2-63 — At right angles to wire; height 1-1/4 wavelength.

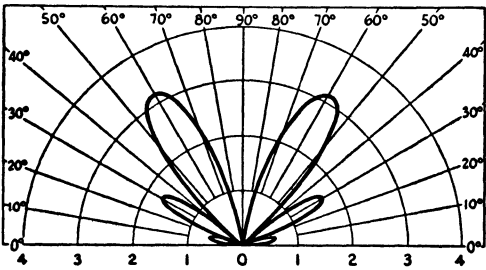

Fig. 2-64 — In direction of wire; height 1-1/2 wavelength.

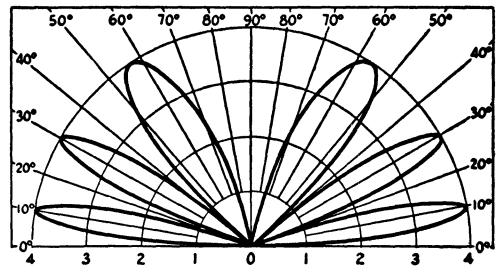

Fig. 2-65 — At right angles to wire; height 1-1/2 wavelength.

then increase to a maximum as the height is increased. The height at which this maximum is obtained is the optimum.

It should be kept in mind that no one wave angle does all the work. Designing for optimum results under average conditions does not mean that best results will be secured for all types of work and under all conditions. For long-distance work, for example, it is best to try for the lowest possible angle — 10 degrees or less is better for multihop propagation at 14 MHz, for example. However, an antenna that radiates well at such low angles may not be as good for work over shorter distances as one having a broader lobe in the vertical plane.

The effect of radiation resistance is somewhat more marked at the lower frequencies. To cover a distance of 200 miles at night (*F*-layer propagation) requires a wave angle of 60 degrees. As shown by the patterns of Figs. 2-24 to 2-26, optimum

antenna height for this wave angle is 1/4 wavelength. However, it is in the region below 1/4 wavelength that the radiation resistance decreases most rapidly. At a height of 1/8 wavelength there is a gain of 3.5 dB over a height of 1/4 wavelength (Fig. 2-52) because of lowered radiation resistance. To offset this, the ground-reflection factor for a wave angle of 60 degrees is about 1.25 at 1/8 wavelength (Fig. 2-24) as compared with 2.0 for 1/4 wavelength; this is a loss of 4 dB. There is thus a difference of only 1-1/2 dB, which is not observable, between 1/8 and 1/4 wavelength. At 3.5 MHz, this is a considerable difference in actual height, since 1/8 $\lambda$  is about 35 feet and 1/4 $\lambda$  is about 70 feet. For *short*-distance work the cost of the supports required for the greater height would not be justified.

Information on the variation in radiation resistance with height for antenna types other than the half-wave dipole is not readily available. A harmon-



ic antenna can be expected to show such variations, but in general an antenna system that tends to minimize the radiation directly toward the ground under the antenna can be expected to have a lesser order of variation in radiation resistance with height than is the case with the half-wave dipole.

**VERTICAL DIRECTIVITY PATTERNS**

It was explained in the preceding section that the directive patterns of Fig. 2-46 to 2-50, inclusive, show the relative intensity of radiation in different compass directions for each wave angle selected, but do not attempt to show the amplitude relationship between the wave angles. This is because the intensity at different wave angles varies with the height of the antenna above the ground, and an extremely large number of diagrams would be needed to represent the range of heights and lengths of antennas encountered in practice. The information on relative intensity at different wave angles is easily secured from the ground-reflection charts.

However, it is helpful in forming a picture of the operation of antennas to use a form of representation in which the vertical directional characteristic is shown for different heights. Inasmuch as we are still confronted by a three-dimensional pattern, it is only possible to do this for selected vertical planes oriented in various directions with respect to the antenna axis. In the case of the horizontal half-wave dipole a plane running in a direction along the axis and another broadside to the antenna will give a good deal of information.

A series of such patterns for a horizontal half-wave dipole at different heights is given in Figs. 2-54 to 2-65, inclusive. It will be noted that the patterns of Figs. 2-54 through 2-57 are the same as those shown in Fig. 2-23, while those shown at right angles to the wire are the same (for the appropriate antenna height) as Figs. 2-24 to 2-35, inclusive. The scale here is simply an arbitrary one in which the length of a radius drawn from the origin to any point on the graph is proportional to field strength (voltage). The reduction in field strength off the ends of the wire at the lower angles, as compared with the broadside field strength, is quite apparent. It is also apparent that, at some heights, the high-angle radiation off the ends is nearly as great as the broadside radiation.

In vertical planes making some angle intermediate between 0 and 90 degrees with the wire axis, the pattern will have a shape intermediate between the two planes shown. By visualizing a smooth transition from the end-on pattern to the broadside pattern as the horizontal angle is varied from 0 to 90 degrees a fairly good mental picture of the actual solid pattern can be formed.

In the case of a vertical half-wave dipole, the horizontal directional pattern is simply a circle at any wave angle (although the actual field strength will vary, at the different wave angles, with the height above ground). Hence one vertical pattern is sufficient to give complete information, for a selected antenna height, about the antenna in any direction with respect to the wire. A series of such patterns is given in Figs. 2-66 to 2-69, inclusive. These patterns are formed by multiplying one lobe

Vertical-plane radiation patterns of vertical half-wave antennas above perfectly conducting ground. The height is that of the center of the antenna. Dotted lines indicate approximate effect of attenuation of the very low-angle radiation because of ground losses.

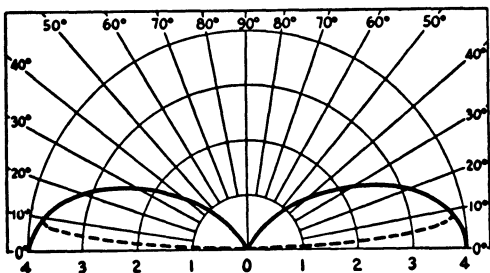

Fig. 2-66 — Height 1/4 wavelength.

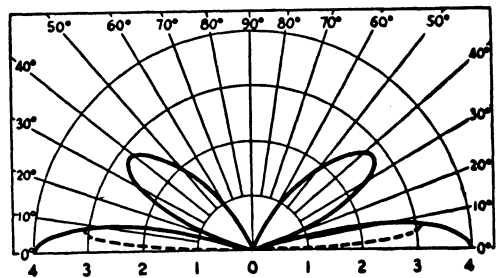

Fig. 2-68 — Height 3/4 wavelength.

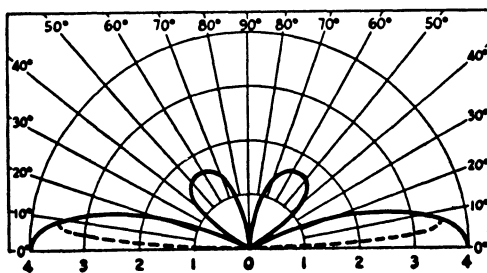

Fig. 2-67 — Height 1/2 wavelength.

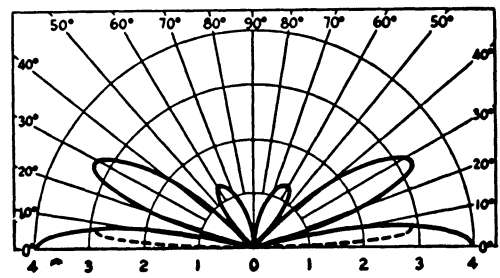

Fig. 2-69 — Height 1 wavelength.

of the free-space pattern of a half-wave dipole by the ground-reflection factor that applies at each wave angle for the antenna height selected, to obtain the resultant relative field strength at each wave angle. The solid pattern in each case is formed by rotating the plane pattern about the 90-degree axis of the graph.

The effect of ground losses at high frequencies is simulated by the broken curves at the very low wave angles. In other respects the curves are based on the assumption that the antenna is erected over perfectly conducting ground.

### SOME PRACTICAL CONSIDERATIONS

At the risk of being repetitious, we must state again that the results from a practical antenna cannot be expected to be exactly according to the theoretical performance outlined in this chapter. The theory that leads to the impedances, radiation patterns, and power-gain figures discussed is necessarily based on idealized assumptions that cannot be exactly realized, although they may be approached, in practice.

The effect of imperfectly conducting earth has been mentioned several times. It will cause the actual radiation resistance of an antenna to differ somewhat from the theoretical figure at a given height. In addition, there is the effect of the length/diameter ratio of the conductor to be considered. Nevertheless, the theoretical figure will approximate the actual radiation resistance closely enough for most practical work. The value of radiation resistance is of principal importance in determining the proper method for feeding power to the antenna through a transmission line, and a variation of 10 or even 20 percent will not be serious. Adjustments can easily be made to compensate for the discrepancy between practice and theory.

So far as radiation patterns are concerned, the effect of imperfect earth is to decrease the amplitude of the reflected ray and to introduce some phase shift on reflection. The phase shift is generally small with horizontal polarization. Both effects combine to make the maximum reflection factor somewhat less than 2, and to prevent complete cancellation of radiation in the nulls in the theoretical patterns, as shown in Fig. 2-43C. There may also be a slight change in the wave angle at which maximum reinforcement occurs, as a result of the phase shift. The effect of ground losses on very low angles already has been emphasized.

Aside from ground effects, the theoretical patterns of the antennas discussed are developed on the basis of sinusoidal distribution of current along the antenna, and on the assumption (in harmonic antennas) that the value of the current is the same at every current loop. Neither is strictly true. In particular, the current in a long harmonic antenna is not the same at every loop because some energy is lost all along the antenna by radiation. This affects both the current going out and the current returning after reflection at the far end of the antenna. The result is that the radiation pattern

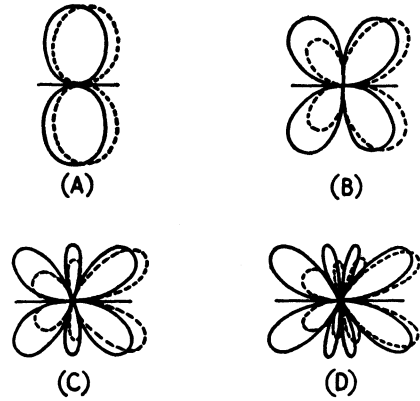

Fig. 2-70 — The effect of feeding an antenna at the end is to cause a tilt to the directional pattern, as shown by these experimentally determined patterns. A, half wave; B, 1 wavelength; C, 1-1/2 wavelengths; D, 2 wavelengths. Solid patterns are theoretical, dotted patterns experimental. In each case the antenna is fed from the left-hand end.

does not have the perfect symmetry indicated in the drawings in this chapter. The lobes pointing away from the end at which the antenna is fed are tilted somewhat toward the direction of the antenna wire, and the lobes pointing toward the fed end are tilted away from the wire. The latter also have less amplitude than the former. Typical measured patterns are shown in Fig. 2-70. There is even a tilt to the pattern of a half-wave antenna when it is fed at one end; however, when such an antenna is fed at the center the pattern is symmetrical.

Finally, the effect of nearby conductors and dielectrics cannot, of necessity, be included in the theoretical patterns. Conductors such as power and telephone lines, house wiring, piping, etc., close to the antenna can cause considerable distortion of the pattern if currents of appreciable magnitude are induced in them. Under similar conditions they can also have a marked effect on the radiation resistance. Poor dielectrics such as green foliage near the antenna can introduce loss, and may make a noticeable difference between summer and winter performance.

The directional effects of an antenna will conform more closely to theory if the antenna is located in clear space, at least a half wavelength from anything that might affect its properties. In

Fig. 2-71 — The half-wave antenna and its grounded quarter-wave counterpart. The missing quarter wavelength can be considered to be supplied by the image in ground of good conductivity.

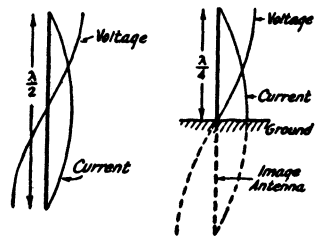

cities, it may be difficult to find such a space at low frequencies. The worst condition arises when nearby wires or piping happen to be resonant, or nearly so, at the operating frequency. Such resonances often can be destroyed by bonding pipes or BX coverings at trial points, checking with a diode-detector wavemeter to determine the measures necessary to reduce the induced current. Metal masts or guy wires can cause distortion of the pattern unless detuned by grounding or by breaking up the wires with insulators. However,

masts and guy wires usually have relatively little effect on the performance of horizontal antennas because, being vertical or nearly so, they do not pick up much energy from a horizontally polarized wave. In considering nearby conductors, too, the transmission line that feeds the antenna should not be overlooked. Under some conditions that are rather typical with amateur antennas, currents will be induced in the line by the antenna, leading to some undesirable effects. This is considered in Chapter Three.

### SPECIAL ANTENNA TYPES

The underlying principles of antenna operation have been discussed in this chapter in terms of the half-wave dipole, which is the elementary form from which more elaborate antenna systems are built. However, there are other types of antennas that find some application in amateur work, particularly when space limitations do not permit using a full-sized dipole. These include, principally, grounded antennas and loops.

#### THE GROUNDED ANTENNA

In cases where vertical polarization is required – for example, when a low wave angle is desired at frequencies below 4 MHz – the antenna must be vertical. At low frequencies the height of a vertical half-wave antenna would be beyond the constructional reach of most amateurs. A 3.5-MHz vertical half wave would be 133 feet high, for instance.

However, if the lower end of the antenna is grounded it need be only a quarter wave high to resonate at the same frequency as an ungrounded half-wave antenna. The operation can be understood when it is remembered that ground having high conductivity acts as an electrical mirror, and the missing half of the antenna is supplied by the mirror image. This is shown in Fig. 2-71.

The directional characteristic of a grounded quarter-wave antenna will be the same as that of a half-wave antenna in free space. Thus a vertical grounded quarter-wave antenna will have a circular radiation pattern in the horizontal plane. In the vertical plane the radiation will decrease from maximum along the ground to zero directly overhead.

The grounded antenna may be much smaller than a quarter wavelength and still be made resonant by “loading” it with inductance at the base, as in Fig. 2-72 at B and C. By adjusting the inductance of the loading coil even very short wires can be tuned to resonance.

The current along a grounded quarter-wave vertical wire varies practically sinusoidally, as is the case with a half-wave wire, and is highest at the ground connection. The rf voltage, however, is highest at the open end and minimum at the ground.

current and voltage distribution are shown in Fig. 2-72A. When the antenna is shorter than a quarter wave but is loaded to resonance, the current and voltage distribution are part sine waves along the antenna wire. If the loading coil is substantially free from distributed capacitance, the voltage across it will increase uniformly from minimum at the ground, as shown at B and C, while the current will be the same throughout.

Extremely short antennas are used, of necessity, in mobile work on the lower frequencies such as the 3.5-MHz band. These may be “base loaded” as shown at B and C in Fig. 2-72, but there is a small advantage to be realized by placing the loading coil at the center of the antenna. In neither case, however, is the current uniform throughout the coil, since the inductance required is so large that the coil tends to act like a linear circuit rather than like a “lumped” inductance.

If the antenna height is greater than a quarter wavelength the antenna shows inductive reactance at its terminals and can be tuned to resonance by means of a capacitance of the proper value. This is shown in Fig. 2-73A. As the length is increased progressively from 1/4 to 1/2 wavelength the current loop moves up the antenna, always being at a point 1/4 wavelength from the top. When the height is 1/2 wavelength the current distribution is as shown at B in Fig. 2-73. There is a voltage loop (current node) at the base, and power can be applied to the antenna through a parallel-tuned circuit, resonant at the same frequency as the antenna, as shown in the figure.

Up to a little more than 1/2 wavelength,

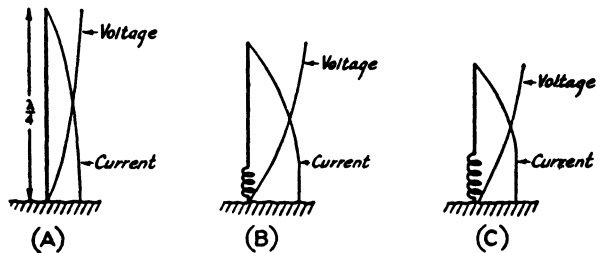

Fig. 2-72 – Current and voltage distribution on a grounded quarter-wave antenna (A) and on successively shorter antennas loaded to resonate at the same frequency.

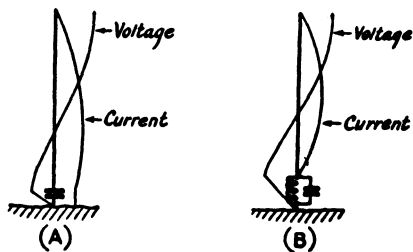

Fig. 2-73 — Current and voltage distribution on grounded antennas longer than  $1/4$  wavelength. (A) between  $1/4$  and  $3/8$  wave, approximately; (B) half wave.

increasing the height compresses the directive pattern in the vertical plane; this results in an increase in field strength for a given power input at the very low radiation angles. The theoretical improvement is about 2 dB for a half-wave antenna as compared with a quarter-wave antenna.

### Radiation Resistance

The radiation resistance of a grounded vertical antenna, as measured between the base of the antenna and ground, varies as shown in Fig. 2-74 as a function of the antenna height. The word "height" as used in this connection has the same meaning as "length" as applied to a horizontal antenna. This curve is for an antenna based on (but not directly connected to) ground of perfect conductivity. The height is given in electrical degrees, the 60-135 degree range shown corresponding to heights from  $1/6$  to  $3/8$  wavelength.

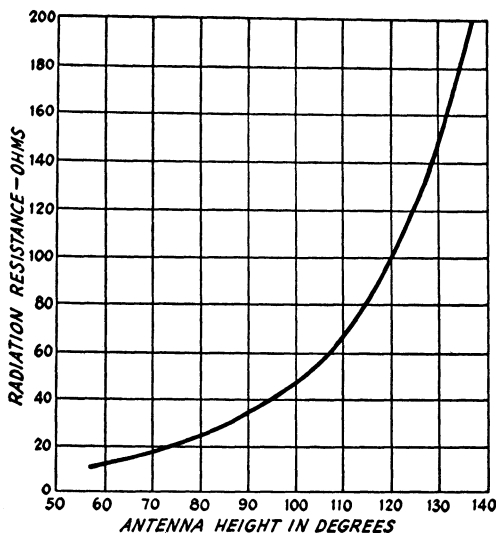

Fig. 2-74 — Radiation resistance vs. free-space antenna height in electrical degrees for a vertical antenna over perfectly conducting ground, or over a highly conducting ground plane. This curve also may be used for center-fed antennas (in free space) by multiplying the radiation resistance by two; the height in this case is half the actual antenna length.

The antenna is approximately self-resonant at a height of 90 degrees ( $1/4$  wavelength). The actual resonant length will be somewhat less because of the length/diameter ratio mentioned earlier.

In the range of heights covered by Fig. 2-74 the radiation resistance is practically independent of the length/diameter ratio. At greater heights the length/diameter ratio is important in determining the actual value of radiation resistance. At a height of  $1/2$  wavelength the radiation resistance may be as high as several thousand ohms.

The variation in radiation resistance with heights below 60 degrees is shown in Fig. 2-75. The values in this range are very low.

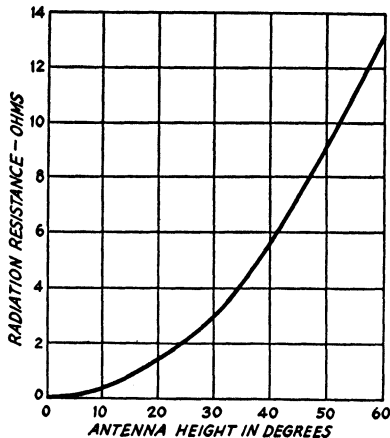

Fig. 2-75 — Same as Fig. 2-74, for heights below 60 degrees.

A very approximate curve of reactance vs. height is given in Fig. 2-76. The actual reactance will depend on the length/diameter ratio, so this curve should be used only as a rough guide. It is based on a ratio of about 1000 to 1. Thicker antennas can be expected to show lower reactance at a given height, and thinner antennas should show more. At heights below and above the range covered by the curve, larger reactance values will be encountered, except for heights in the vicinity of  $1/2$  wavelength. In this region the reactance decreases, becoming zero when the antenna is resonant.

### Efficiency

The efficiency of the antenna is the ratio of the radiation resistance to the total resistance of the system. The total resistance includes radiation resistance, resistance in conductors and dielectrics, including the resistance of loading coils if used, and the resistance of the grounding system, usually referred to as "ground resistance."

It was stated earlier in this chapter that a half-wave antenna operates at very high efficiency because the conductor resistance is negligible compared with the radiation resistance. In the case of the grounded antenna the ground resistance usually is not negligible, and if the antenna is short (compared with a quarter wavelength) the resistance of the necessary loading coil may become

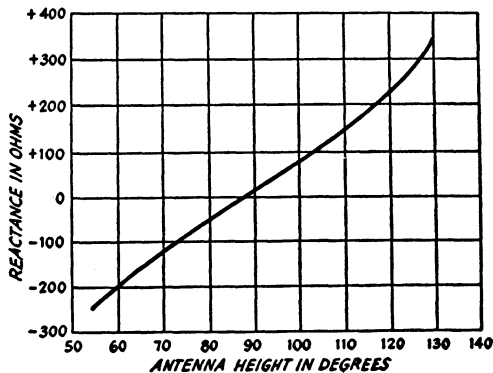

Fig. 2-76 — Approximate reactance of a vertical antenna over perfectly conducting ground and having a length/diameter ratio of about 1000. Actual values will vary considerably with length/diameter ratio. The remarks under Fig. 2-74 also apply to this curve.

appreciable. To attain an efficiency comparable with that of a half-wave antenna, in a grounded antenna having a height of 1/4 wavelength or less, great care must be used to reduce both ground resistance and the resistance of any required loading inductors. Without a fairly elaborate grounding system, the efficiency is not likely to exceed 50 percent and may be much less, particularly at heights below 1/4 wavelength.

**Grounding Systems**

The ideal grounding system for a vertical grounded antenna would consist of about 120 wires, each at least 1/2 wavelength long, extending radially from the base of the antenna and spaced equally around a circle. Such a system is the practical equivalent of perfectly conducting ground and has negligible resistance. The wires can either be laid directly on the surface of the ground or buried a few inches below.

Such a system would be practical in an amateur installation in very few cases. Unfortunately, the resistance increases rapidly when the number of radials is reduced, and if at all possible at least 15 radials should be used. Experimental measurements have shown that even with this number the resistance is such as to decrease the antenna efficiency to about 50 percent at a height of 1/4 wavelength.

It has also been found that as the number of radials is reduced the length required for optimum results with a particular number of radials also decreases; in other words, if only a small number of radials can be used there is no point in extending them out a half wavelength. With 15 radials, for example, a length of 1/8 wavelength is sufficient. With as few as two radials the length is almost unimportant, but the efficiency of a quarter-wave antenna with such a grounding system is only about 25 percent. It is considerably lower with shorter antennas.

In general, a large number of radials, even though some or all of them have to be short, is

preferable to a few long radials. The conductor size is relatively unimportant, No. 12 to No. 28 copper wire being suitable.

The measurement of ground resistance at the operating frequency is difficult. The power loss in the ground depends on the current concentration near the base of the antenna, and this depends on the antenna height. Typical values for small radial systems (15 or less) have been measured to be from about 5 to 30 ohms, for antenna heights from 1/16 to 1/4 wavelength.

Additional information on ground losses is contained in Chapter Seven.

**Top Loading**

Because of the difficulty of obtaining a really low-resistance ground system, it is always desirable to make a grounded vertical antenna as high as possible, since this increases the radiation resistance. (There is no point in going beyond a half wavelength, however, as the radiation resistance decreases with further increases in height.) At the low frequencies where a grounded antenna is generally used, the heights required for the realization of high radiation resistance usually are impracticable for amateur work. The objective of design of vertical grounded antennas which are necessarily 1/4 wavelength or less high is to make the current loop come near the top of the antenna, and to keep the current as large as possible throughout the length of the vertical wire. This requires "top loading," which means replacing the missing height by some form of electrical circuit having the same characteristics as the missing part of the antenna, so far as energy traveling up to the end of the antenna is concerned.

One method of top loading is shown in Fig. 2-77. The vertical section of the antenna terminates in a "flat-top" which supplies a capacitance at the top into which current can flow. The simple single-conductor system shown at A is more readily visualized as a continuation of the antenna so that the dimension *X* is essentially the overall length of the antenna. If this dimension is a half wavelength, the resistance at the antenna terminals (indicated by the small circles, one being grounded) will be high. A disadvantage of this system is that the horizontal portion also radiates to some extent, although there is cancellation of radiation in the direction at right angles to the wire direction, since the currents in the two portions are flowing in opposite directions.

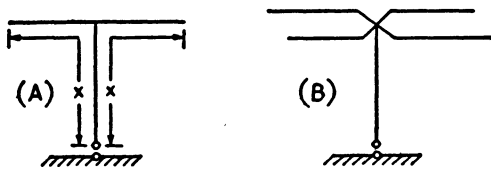

Fig. 2-77 — Simple top loading of a vertical antenna. The antenna terminals, indicated by the small circles, are the base of the antenna and ground, and should not be taken to include the length of any lead-ins or connecting wires.

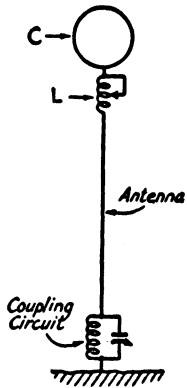

Fig. 2-78 — Top loading with lumped constants. The inductance,  $L$ , should be adjusted to give maximum field strength with constant power input to the antenna. A parallel-tuned circuit, independently resonant at the operating frequency, is required for coupling to the transmitter when the top loading is adjusted to bring a current node at the lower end of the antenna.

A multiwire system such as is shown at B will have more capacitance than the single-conductor arrangement and thus will not need to be as long, for resonating at a given frequency, but requires extra supports for the additional wires. Ideally, an arrangement of this sort should be in the form of a cross, but parallel wires separated by several feet will give a considerable increase in capacitance over a single wire. With either system shown in Fig. 2-77, dimension  $X$ , the length from the base of the antenna along one conductor to the end, should be not more than one-half wavelength nor less than one-fourth wavelength.

Instead of a flat top, it is possible to use a simple vertical wire with concentrated capacitance and inductance at its top to simulate the effect of the missing length. The capacitance used is not the usual type of capacitor, which would be ineffective since the connection is one-sided, but consists of a metallic structure large enough to have the necessary self-capacitance. Practically any sufficiently large metallic structure can be used for the purpose, but simple geometric forms such as the sphere, cylinder and disk are preferred because of the relative ease with which their capacitance can

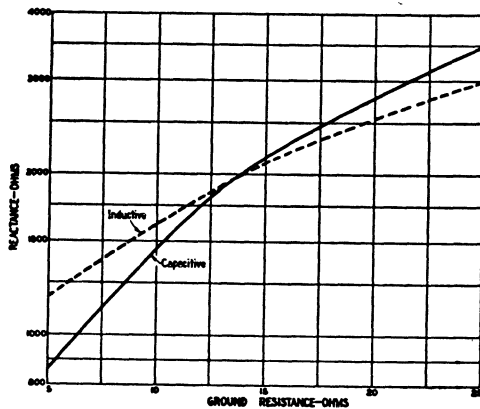

Fig. 2-79 — Inductive and capacitive reactance required for top loading a grounded antenna by the method shown in Fig. 2-78. The reactance values should be converted to inductance and capacitance, using the ordinary formulas, at the operating frequency.

be calculated. The inductance may be the usual type of rf coil, with suitable protection from the weather.

The minimum value of capacitive reactance required depends principally upon the ground resistance. Fig. 2-79 is a set of curves giving the reactances required under representative conditions. These curves are based on obtaining 75 percent of the maximum possible increase in field strength over an antenna of the same height without top loading, and apply with sufficient accuracy to all antenna heights. An inductance coil of reasonably low-loss construction is assumed. The general rule is to use as large a capacitance (low capacitive reactance) as the circumstances will permit, since an increase in capacitance will cause an improvement in the field strength. It is particularly important to do this when, as is usually the case, the ground resistance is not known and cannot be measured.

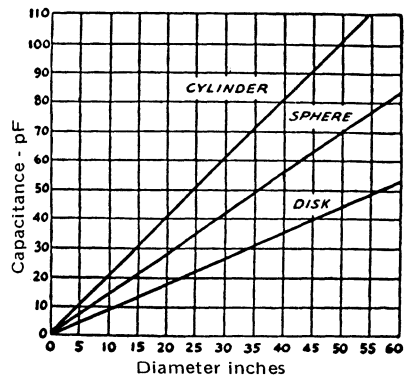

Fig. 2-80 — Capacitance of sphere, disk and cylinder as a function of their diameters. The cylinder length is assumed equal to its diameter.

The capacitance of three geometric forms is shown by the curves of Fig. 2-80 as a function of their size. For the cylinder, the length is specified equal to the diameter. The sphere, disk and cylinder can be constructed from sheet metal, if such construction is feasible, but the capacitance will be practically the same in each case if a "skeleton" type of construction with screening or networks of wire or aluminum tubing is used.

#### Ground-Plane Antennas

Instead of being actually grounded, a  $1/4$ -wave antenna can work against a simulated ground called a ground plane. Such a simulated ground can be formed from wires  $1/4$  wavelength long radiating from the base of the antenna, as shown in Fig. 2-81. It is obvious that with  $1/4$ -wave radials the antenna and any one radial have a total length of  $1/2$  wavelength and therefore will be a resonant system. However, with only one radial the directive pattern would be that of a half-wave antenna bent into a right angle at the center; if one section is vertical and the other horizontal this would result in equal components of horizontal and vertical polarization and a nonuniform pattern in the

horizontal plane. This can be overcome by using a ground plane in the shape of a disk with a radius of  $1/4$  wavelength. The effect of the disk can be simulated, with simpler construction, by using at least four straight radials equally spaced around the circle, as indicated in the drawing.

The ground-plane antenna is widely used at vhf, for the purpose of establishing a "ground" for a vertical antenna mounted many wavelengths above actual ground. This prevents a metallic antenna support from carrying currents that tend to turn the system into the equivalent of a vertical long-wire antenna and thus raising the wave angle.

At frequencies of the order of 14 to 30 MHz, a ground plane of the type shown in Fig. 2-81 will permit using a quarter-wave vertical antenna (for nondirectional low-angle operation) at a height that will let the antenna be clear of its surroundings. Such short antennas mounted on the ground itself are frequently so surrounded by energy-absorbing structures and trees as to be rather ineffective. Since the quarter-wave radials are physically short at these frequencies, it is quite practical to mount the entire system on a roof top or pole. A ground plane at a height of a half wavelength or more closely approximates perfectly conducting earth, and the resistance curve of Fig. 2-74 applies with reasonable accuracy. The antenna itself may be any desirable height and does not have to be exactly a quarter wavelength. The radials, however, preferably should be quite close to a quarter wave in length.

A ground plane also can be of considerable benefit at still lower frequencies provided the radials and the base of the antenna can be a moderate height above the ground. In order to take over the function of the actual ground connection, the ground plane must be so disposed that the field of the antenna prefers to travel along the ground-plane wires instead of in the ground itself, thus confining the current to the highly conducting wires rather than letting it flow in lossy earth. This is particularly necessary where the current is greatest, i.e., close to the antenna. If the ground plane has to be near the earth, the number of wires should be increased, using as many as is practicable and spacing them as evenly as possible in a circle around the antenna. If the construction of a multiwire ground plane is impracticable, a better plan is to bury as many radials as possible in the ground as described earlier.

## SHORT ANTENNAS IN GENERAL

Although the discussions in this chapter have principally been in terms of self-resonant antennas, particularly those a half wavelength long, it would be a mistake to assume that there is anything peculiarly sacred about resonance. The resonant length happens to be one that is convenient to analyze. At other lengths the directive properties will be different, the radiation resistance will be different, and the impedance looking into the terminals of the antenna will contain reactance as well as resistance. The reactance presents no

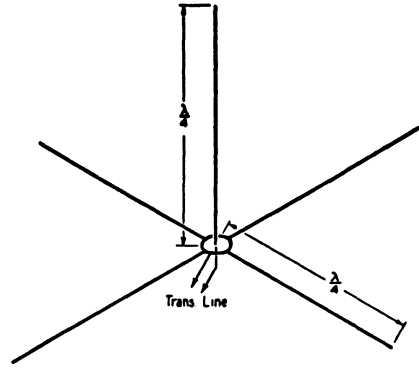

Fig. 2-81 — The ground-plane antenna. Power is applied between the base of the antenna and the center of the ground plane, as indicated in the drawing.

problem, because it can easily be "tuned out" and the antenna system thereby resonated, even though the antenna by itself is *not* resonant. The purpose of resonating either the antenna or the system as a whole is simply to facilitate feeding power to the antenna, and such resonating or tuning does not affect the antenna's radiating properties.

Physical conditions frequently make it necessary to use antennas shorter than a half wavelength. The directive pattern of a short antenna does not differ greatly from that of a half-wave antenna, and in the limit the pattern approaches that shown in Fig. 2-12. The difference in the field strength that this shift in pattern shape causes is negligible. The most important difference is the decrease in radiation resistance and its effect on the efficiency of the antenna. This has been discussed in the preceding section on grounded antennas. The curve of Figs. 2-74 and 2-75 can be used for any center-fed nongrounded antenna by using half the actual antenna length and multiplying the corresponding radiation resistance by two. For example, a center-fed dipole antenna having an actual length of 120 degrees ( $1/3$  wavelength) has a half length of 60 degrees and a radiation resistance of about 13 ohms per side or 26 ohms for the whole antenna. The reactance, which will be capacitive and of the order of 400 ohms (Fig. 2-76, same technique as above), can be tuned out by a loading coil or coils. As described earlier, low-resistance coils must be used if the antenna efficiency is to be kept reasonably high. However, the ground resistance loss can be neglected in a horizontal center-fed antenna of this type if the height is a quarter wavelength or more.

A short antenna should not be made shorter than the physical circumstances require, because the efficiency decreases rapidly as the antenna is made shorter. For example, a center-fed antenna having an overall length of  $1/4$  wavelength (half length 45 degrees) will have a radiation resistance of  $2 \times 7 = 14$  ohms, as shown by Fig. 2-75. Depending on the length/diameter ratio, the reactance will be 500 to 1000 ohms. A loading coil of the same reactance probably will have a resistance

of 3 to 6 ohms, so the probable efficiency will be 70 to 80 percent, or a loss of 1 to 1.5 dB. While this is not too bad, further shortening not only further decreases the radiation resistance but enters a length region where the reactance increases very rapidly, so that the coil resistance quickly becomes larger than the radiation resistance. Where the antenna must be short, a small length/diameter ratio (thick antenna) is definitely desirable as a means of keeping down the reactance and thus reducing the size of loading inductance required.

## LOOP ANTENNAS

A loop antenna is a closed-circuit antenna — that is, one in which a conductor is formed into one or more turns so that its two ends are close together. Loops can be divided into two general classes, those in which both the total conductor length and the maximum linear dimension of a turn are very small compared with the wavelength, and those in which both the conductor length and the loop dimensions begin to be comparable with the wavelength.

A “small” loop can be considered to be simply a rather large coil, and the current distribution in such a loop is the same as in a coil. That is, the current is in the same phase and has the same amplitude in every part of the loop. To meet this condition the total length of conductor in the loop must not exceed about 0.8 wavelength. Small loops are discussed further in the chapter on Specialized Antennas.

A “large” loop is one in which the current is not the same either in amplitude or phase in every part of the loop. This change in current distribution gives rise to entirely different properties as compared with a small loop.

### Half-Wave Loops

The smallest size of “large” loop generally used is one having a conductor length of  $1/2$  wavelength. The conductor is usually formed into a square, as shown in Fig. 2-82, making each side  $1/8$  wavelength long. When fed at the center of one side the current flows in a closed loop as shown at A. The current distribution is approximately the same as on a half-wave wire, and so is maximum at the center of the side opposite the terminals X-Y, and minimum at the terminals themselves. This current distribution causes the field strength to be

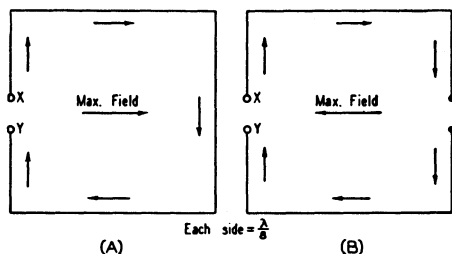

Fig. 2-82 — Half-wave loops, consisting of a single turn having a total length of  $1/2$  wavelength.

maximum in the plane of the loop and in the direction looking from the low-current side to the high-current side. If the side opposite the terminals is opened at the center as shown at B (strictly speaking, it is then no longer a loop because it is no longer a closed circuit) the direction of current flow remains unchanged but the maximum current flow occurs at the terminals. This reverses the direction of maximum radiation.

The radiation resistance at a current antinode (which is also the resistance at X-Y in Fig. 2-82B) is of the order of 50 ohms. The impedance at the terminals in A is a few thousand ohms. This can be reduced by using two identical loops side by side with a few inches spacing between them and applying power between terminal X on one loop and terminal Y on the other.

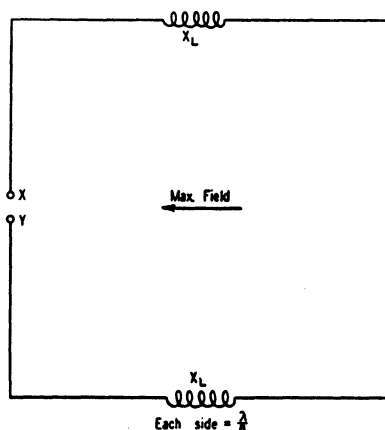

Fig. 2-83 — Inductive loading in the sides of a half-wave loop to increase the directivity and gain. Maximum radiation or response is in the plane of the loop in the direction shown by the arrow.

Unlike a half-wave dipole or a small loop, there is no direction in which the radiation from a loop of the type shown in Fig. 2-82 is zero. There is appreciable radiation in the direction perpendicular to the plane of the loop, as well as to the “rear” — the opposite direction to the arrows shown. The front-to-back ratio is of the order of 4 to 6 dB. The small size and the shape of the directive pattern result in a loss of about 1 dB when the field strength in the optimum direction from such a loop is compared with the field from a half-wave dipole in its optimum direction.

The ratio of the forward radiation to the backward radiation can be increased and the field strength likewise increased at the same time to give a gain of about 1 dB over a dipole, by using inductive reactances to “load” the sides joining the front and back of the loop. This is shown in Fig. 2-83. The reactances, which should have a value of approximately 360 ohms, decrease the current in the sides in which they are inserted and increase it in the side having the terminals. This increases the directivity and thus increases the efficiency of the loop as a radiator.



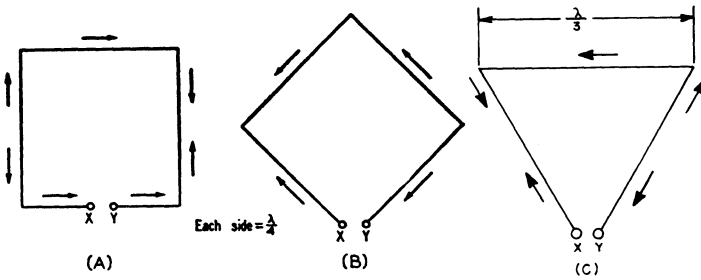

Fig. 2-84 — At A and B, loops having sides 1/4 wavelength long, and at C having sides 1/3 wavelength long (total conductor length one wavelength). The polarization depends on the orientation of the loop and the point at which the terminals X-Y are located.

**One-Wavelength Loops**

Loops in which the conductor length is one wavelength have different characteristics than half-wave loops. Three forms of one-wavelength loops are shown in Fig. 2-84. At A and B the sides of the squares are equal to 1/4 wavelength, the difference being in the point at which the terminals are inserted. At C the sides of the triangle are equal to 1/3 wavelength. The relative direction of current flow is as shown in the drawings. This direction reverses halfway around the perimeter of the loop, since such reversals always occur at the junction of each half-wave section of wire.

The directional characteristics of loops of this type are opposite in sense to those of a small loop. That is, the radiation is maximum perpendicular to the plane of the loop and is minimum in any direction in the plane containing the loop. If the three loops shown in Fig. 2-84 are mounted in a vertical plane with the terminals at the bottom, the radiation is horizontally polarized. When the terminals are moved to the center of one vertical side in A, or to a side corner in B, the radiation is vertically polarized. If the terminals are moved to a side corner in C, the polarization will be diagonal, containing both vertical and horizontal components.

In contrast to straight-wire antennas, the electrical length of the circumference of a one-wavelength loop is *shorter* than the actual length. For loops made of wire and operating at frequencies below 30 MHz or so, where the ratio of conductor length to wire diameter is large, the loop will be close to resonance when

$$\text{Length (ft)} = \frac{1005}{f \text{ (MHz)}}$$

or

$$\text{Length (m)} = \frac{306.3}{f \text{ (MHz)}}$$

The radiation resistance of a resonant one-wavelength loop is approximately 100 ohms, when the ratio of conductor length to diameter is large. As the loop dimensions are comparable with those of a half-wave dipole, the radiation efficiency is high.

In the direction of maximum radiation (that is, broadside to the plane of the loop, regardless of the point at which it is fed) the one-wavelength loop will show a small gain over a half-wave dipole. Theoretically, this gain is about 2 dB, and measurements have confirmed that it is of this order.

The one-wavelength loop is more frequently used as an element of a directive antenna array (the quad and delta-loop antennas described in later chapters) than singly, although there is no reason why it cannot be used alone. In the quad and delta loop, it is nearly always driven so that the polarization is horizontal.

**FOLDED DIPOLES**

In the diagram shown in Fig. 2-85, suppose for the moment that the upper conductor between points B and C is disconnected and removed. The system is then a simple center-fed dipole, and the direction of current flow along the antenna and line at a given instant is as given by the arrows. Then if the upper conductor between B and C is restored, the current in it will flow away from B and toward C, in accordance with the rule for reversal of direction in alternate half-wave sections along a wire. However, the fact that the second wire is “folded” makes the currents in the two conductors of the antenna flow in the *same* direction. Although the antenna physically resembles a transmission line (see Chapter Three) it is not actually a line but is merely two conductors in parallel. The connections at the ends of the two are assumed to be of negligible length.

A half-wave dipole formed in this way will have the same directional properties and total radiation resistance as an ordinary dipole. However, the transmission line is connected to only *one* of the conductors. It is therefore to be expected that the antenna will “look” different, in respect to its input impedance, as viewed by the line.

The effect on the impedance at the antenna input terminals can be visualized quite readily. The center impedance of the dipole *as a whole* is the same as the impedance of a single-conductor dipole — that is, approximately 70 ohms. A given amount of power will therefore cause a definite value of

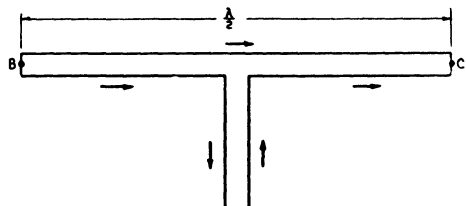

Fig. 2-85 — Direction of current flow in a folded dipole and associated transmission line.

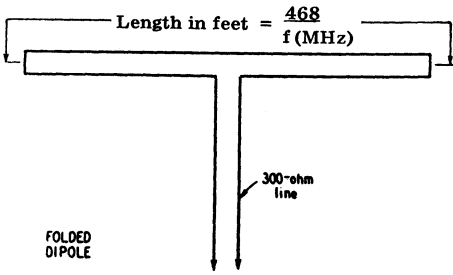

Fig. 2-86 – The folded dipole.

current,  $I$ . In the ordinary half-wave dipole this current flows at the junction of the line and antenna. In the folded dipole the same total current also flows, but is equally divided between two conductors in parallel. The current in each conductor is therefore  $I/2$ . Consequently, the line “sees” a higher impedance because it is delivering the same power at only half the current. It is easy to show that the new value of impedance is equal to four times the impedance of a simple dipole. If more wires are added in parallel the current

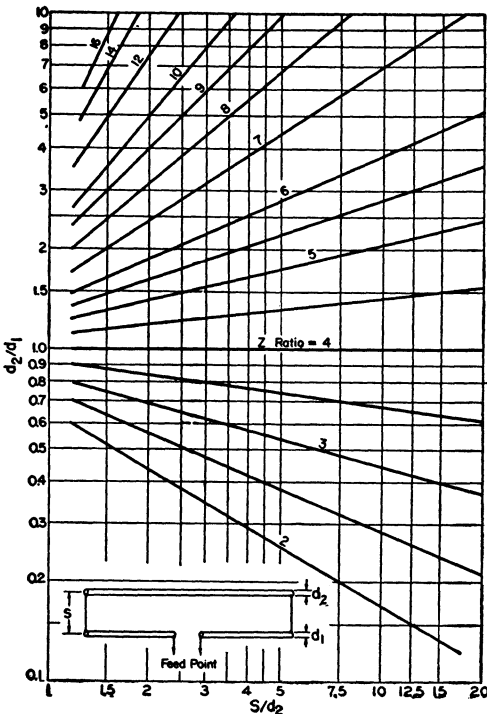

Fig. 2-87 – Impedance step-up ratio for the two-conductor folded dipole, as a function of conductor diameters and spacing. Dimensions  $d_1$ ,  $d_2$  and  $S$  are shown in the inset drawing. The step-up ratio,  $r$ , may also be determined from:

$$r = \left( 1 + \frac{\log \frac{2S}{d_1}}{\log \frac{2S}{d_2}} \right)^2$$

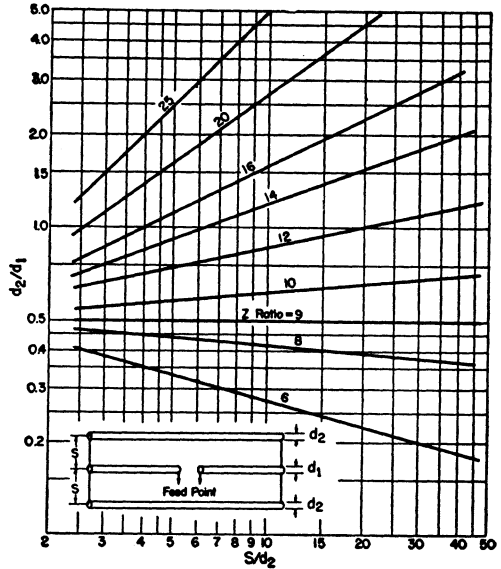

Fig. 2-88 – Impedance step-up ratio for the three-conductor folded dipole. The conductors that are not directly driven must have the same diameter, but this diameter need not be the same as that of the driven conductor. Dimensions are indicated in the inset.

continues to divide between them and the terminal impedance is raised still more. This explanation is a simplified one based on the assumption that the conductors are close together and have the same diameter.

The two-wire system in Fig. 2-86 is an especially useful one because the input impedance is so close to 300 ohms that it can be fed directly with 300-ohm Twin-Lead or open line without any other matching arrangement.

The folded dipole has a somewhat “flatter” impedance-vs.-frequency characteristic than a simple dipole. That is, the reactance varies less rapidly, as the frequency is varied on either side of resonance, than with a single-wire antenna.

### Harmonic Operation

A folded dipole will not accept power at twice the fundamental frequency, or any even multiples of the fundamental. At such multiples the folded section simply acts like a continuation of the transmission line. No other current distribution is possible if the currents in the two conductors of the actual transmission lines are to flow in opposite directions.

On the third and other odd multiples of the fundamental the current distribution is correct for operation of the system as a folded antenna. Since the radiation resistance of a  $3/2$ -wave antenna is not greatly different from that of a half-wave antenna, a folded dipole can be operated on its third harmonic.

### Multi- and Unequal-Conductor Folded Dipoles

Larger impedance ratios than 4 to 1 are frequently desirable when the folded dipole is used as the driven element in a directive array because the radiation resistance is frequently quite low. A wide choice of impedance step-up ratios is available by varying the relative size and spacing of the conductors, and by using more than two. Fig. 2-87 gives design information of this nature for two-conductor folded dipoles and Fig. 2-88 is a similar chart for three-conductor dipoles. Fig. 2-88 assumes that the three conductors are in the same plane, and that the two that are not directly connected to the transmission line are equally spaced from the driven conductor.

In computing the length of a folded dipole using thick conductors — i.e., tubing such as is used in rotary beam antennas — it should be remembered that the resonant length may be appreciably less than that of a single-wire antenna cut for the same frequency. Besides the shortening required with thick conductors, as discussed earlier in this chapter, the parallel conductors tend to act like the boundaries of a conducting sheet of the same width as the spacing between the conductors. The

“effective diameter” of the folded dipole will lie somewhere between the actual conductor diameter and the maximum distance between conductors. The relatively large effective thickness of the antenna reduces the rate of change of reactance with frequency, so the tuning becomes relatively broad and the antenna length is not too critical for a given frequency.

Further information on the folded dipole, as pertains to feeding and matching, is contained in Chapter Three in the section, *Coupling the Line to the Antenna*.

### OTHER TYPES OF ANTENNAS

The half-wave dipole and the few special types of antennas described in this chapter form the basis for practically all antenna systems in amateur use at frequencies from the vhf region down. Other fundamental types of radiators are applicable at microwaves, but they are not used at lower frequencies because the dimensions are such as to be wholly impracticable when the wavelength is measured in meters rather than centimeters.

### Bibliography

Source material and more extended discussion of topics covered in this chapter can be found in the references given below.

- Brown, Lewis and Epstein, “Ground Systems as a Factor in Antenna Efficiency,” *Proc. I.R.E.*, June, 1937.
- Carter, Hansell and Lindenblad, “Development of Directive Transmitting Antennas by R.C.A. Communications,” *Proc. I.R.E.*, October, 1931.
- Dome, “Increased Radiating Efficiency for Short Antennas,” *QST*, September, 1934.
- Grammer, “The All-Around Radiation Characteristics of Horizontal Antennas,” *QST*, November, 1936.
- Grammer, “More on the Directivity of Horizontal Antennas,” *QST*, March, 1937.
- King, Mimno and Wing, *Transmission Lines, Antennas and Wave Guides*, McGraw-Hill Book Co., New York, N.Y.
- Lindsay, “Quads and Yagis,” *QST*, May, 1968.
- Reinartz, “Half-Wave Loop Antennas,” *QST*, October, 1937.
- Terman, *Radio Engineering*, McGraw-Hill Book Co., New York, N.Y.
- Williams, “Radiating Characteristics of Short-Wave Loop Aerials,” *Proc. I.R.E.*, October, 1940.
- Textbooks on Antennas and Transmission Lines
- Jasik, *Antenna Engineering Handbook*, McGraw-Hill Book Co., New York, N.Y.
- Johnson, *Transmission Lines and Networks*, McGraw-Hill Book Co., New York, N.Y.
- Jordan, *Electromagnetic Waves and Radiation Systems*, Prentice-Hall, Inc., Englewood Cliffs, New Jersey.
- King, *The Theory of Linear Antennas*, Harvard University Press, Cambridge, Mass.
- Laport, *Radio Antenna Engineering*, McGraw-Hill Book Co., New York, N.Y.
- Kraus, *Antennas*, McGraw-Hill Book Co., New York, N.Y.
- Schelkunoff, *Advanced Antenna Theory*, John Wiley & Sons, Inc., New York, N.Y.
- Schelkunoff and Friis, *Antenna Theory and Practice*, John Wiley & Sons, Inc., New York, N.Y.
- Skilling, *Electric Transmission Lines*, McGraw-Hill Book Co., New York, N.Y.
- Slurzberg and Osterheld, *Essentials of Radio*, McGraw-Hill Book Co., New York, N.Y.
- Southworth, *Principles and Applications of Waveguide Transmission*, D. Van Nostrand Co., Inc., New York, N.Y.

# Transmission Lines

The desirability of installing an antenna in a clear space, not too near buildings or power and telephone lines, has been emphasized in the preceding chapter. On the other hand, the transmitter that generates the rf power for driving the antenna is usually, as a matter of necessity, located at some distance from the antenna terminals. The connecting link between the two is the rf transmission line or feeder. Its sole purpose is to carry rf power from one place to another, and to do it as efficiently as possible. That is, the ratio of the power *transferred* by the line to the power *lost* in it should be as large as the circumstances will permit.

At radio frequencies every conductor that has appreciable length compared with the wavelength in use will *radiate* power. That is, every conductor becomes an antenna. Special care must be used, therefore, to minimize radiation from the conductors used in rf transmission lines. Without such care, the power radiated by the line may be much larger than that which is lost in the resistance of conductors and dielectrics. Power loss in resistance is inescapable, at least to a degree, but loss by radiation is largely avoidable.

### Preventing Radiation

Radiation loss from transmission lines can be prevented by using two conductors so arranged and operated that the electromagnetic field from one is balanced everywhere by an equal and opposite field from the other. In such a case the resultant field is zero everywhere in space; in other words, there is no radiation.

For example, Fig. 3-1A shows two parallel conductors having currents  $I_1$  and  $I_2$  flowing in opposite directions. If the current  $I_1$  at point  $Y$  on the upper conductor has the same amplitude as the current  $I_2$  at the corresponding point  $X$  on the lower conductor, the fields set up by the two currents will be equal in magnitude. Because the two currents are flowing in opposite directions, the field from  $I_1$  at  $Y$  will be 180 degrees out of phase with the field from  $I_2$  at  $X$ . However, it takes a measurable interval of time for the field from  $X$  to travel to  $Y$ . If  $I_1$  and  $I_2$  are alternating currents, the phase of the field from  $I_1$  at  $Y$  will have changed in such a time interval, and so at the instant the field from  $X$  reaches  $Y$  the two fields at  $Y$  are not exactly 180 degrees out of phase. The two fields will be exactly 180 degrees out of phase

at every point in space only when the two conductors occupy the same space – an obviously impossible condition if they are to remain separate conductors.

The best that can be done is to make the two fields cancel each other as completely as possible. This can be accomplished by making the distance,  $d$ , between the two conductors small enough so that the time interval during which the field from  $X$  is moving to  $Y$  is a very small part of a cycle. When this is the case the phase difference between the two fields at any given point will be so close to 180 degrees that the cancellation is practically complete.

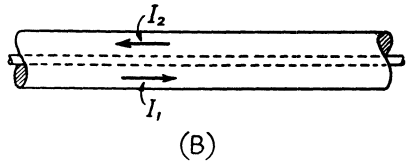
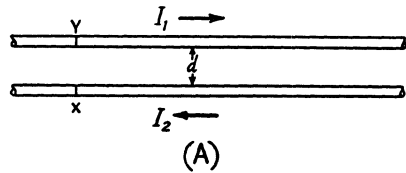

Fig. 3-1 – The two basic types of transmission lines.

Practicable values of  $d$ , the separation between the two conductors, are determined by the physical limitations of line construction. A separation that meets the condition of being “very small” at one frequency may be quite large at another. For example, if  $d$  is six inches, the phase difference between the two fields at  $Y$  will be only a fraction of a degree if the frequency is 3500 kHz. This is because a distance of six inches is such a small fraction of a wavelength (one wavelength = 360 degrees) at 3500 kHz. But at 144 MHz the phase difference would be 26 degrees, and at 420 MHz it would be 73 degrees. In neither of these cases could the two fields be considered to “cancel”

each other. The separation must be very small in comparison with the wavelength used; it should never exceed 1 percent of the wavelength, and smaller separations are desirable.

Transmission lines consisting of two parallel conductors as in Fig. 3-1A are called parallel-conductor lines, or open-wire lines, or two-wire lines.

A second general type of line construction is shown in Fig. 3-1B. In this case one of the conductors is tube-shaped and encloses the other conductor. This is called a coaxial line ("coax") or concentric line. The current flowing on the inner conductor is balanced by an equal current flowing in the opposite direction on the inside surface of the outer conductor. Because of skin effect the current on the inner surface of the tube does not penetrate far enough to appear on the outer surface. In fact, the total electromagnetic field outside the coaxial line, as a result of currents flowing on the conductors inside, always is zero because the tube acts as a shield at radio frequencies. The separation between the inner conductor and the outer conductor is therefore unimportant from the standpoint of reducing radiation.

**CURRENT FLOW IN LONG LINES**

In Fig. 3-2, imagine that the connection between the battery and the two wires is made instantaneously and then broken. During the time the wires are in contact with the battery terminals, electrons in wire No. 1 will be attracted toward the positive battery terminal and an equal number of electrons in wire No. 2 will be repelled away from the negative terminal. This happens only near the battery terminals at first, since electrical effects do not travel at infinite speed, so some time will elapse before the currents become evident at more extreme parts of the wires. By ordinary standards the elapsed time is very short, since the speed of travel along the wires may be almost 300,000,000 meters per second, so it becomes necessary to measure time in millionths of a second (microseconds) rather than in more familiar time units.

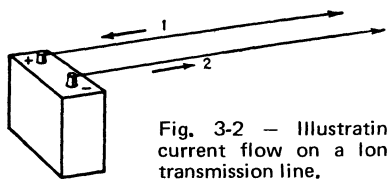

Fig. 3-2 — Illustrating current flow on a long transmission line.

For example, suppose that the contact with the battery is so short that it can be measured in a very small fraction of a microsecond. Then the "pulse" of current that flows at the battery terminals during this time can be represented by the vertical line in Fig. 3-3. At the speed of light, this pulse will travel 30 meters along the line in 0.1 microsecond; 30 meters more, making a total of 60 meters, in 0.2 microsecond; a total of 90 meters in 0.3 microsecond, and so on for as far as the line reaches. The current does not exist all along the wires but is only present at the point that the pulse

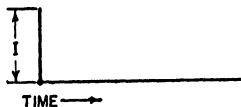
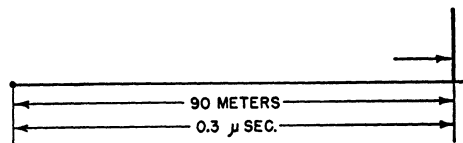
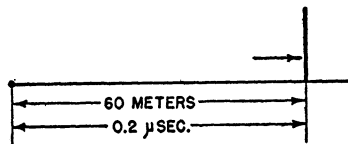
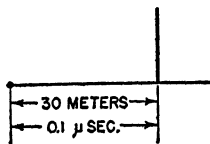

Fig. 3-3 — A current pulse traveling along a transmission line at the speed of light would reach the successive positions shown at intervals of 0.1 microsecond.



has reached in its travel; at this point it is present in both wires, with the electrons moving in one direction in one wire and in the other direction in the other wire. If the line is infinitely long and has no resistance or other cause of energy loss, the pulse will travel undiminished forever.

Extending the example of Fig. 3-3, it is not hard to see that if instead of one pulse we started a whole series of them on the line at equal time intervals, they would travel along the line with the same time and distance spacing between them, each pulse independent of the others. In fact, each pulse could have a different amplitude, if the battery voltage were varied to that end. Furthermore, the pulses could be so closely spaced that they touched each other, in which case we should have current present everywhere along the line simultaneously.

**Wavelength**

It follows from this that an alternating voltage applied to the line would give rise to the sort of current flow shown in Fig. 3-4. If the frequency of the ac voltage is 10,000,000 hertz (cycles per second) or 10 MHz, each cycle will occupy 0.1 microsecond, so a complete cycle of current will be present along each 30 meters of line. This is a distance of one wavelength. Any currents observed at B and D occur just one cycle later in time than the currents at A and C. To put it another way, the currents initiated at A and C do not appear at B and D, one wavelength away, until the applied voltage has had time to go through a complete cycle.

Since the applied voltage is always changing, the currents at A and C are changing in proportion. The current a short distance away from A and C — for instance, at X and Y — is not the same as the

current at *A* and *C* because the current at *X* and *Y* was caused by a value of voltage that occurred slightly earlier in the cycle. This is true all along the line; at any instant the current anywhere along the line from *A* to *B* and *C* to *D* is different from the current at every other point in that same distance. The series of drawings shows how the instantaneous currents might be distributed if we could take snapshots of them at intervals of one-quarter cycle. The current travels out from the input end of the line in waves.

At any selected point on the line the current goes through its complete range of ac values in the time of one cycle just as it does at the input end. Therefore (if there are no losses) an ammeter inserted in either conductor would read exactly the same current at any point along the line, because the ammeter averages the current over a whole cycle. The *phases* of the currents at any two separated points would be different, but an ammeter cannot show phase.

**Velocity of Propagation**

In the example above it was assumed that energy traveled along the line with the velocity of

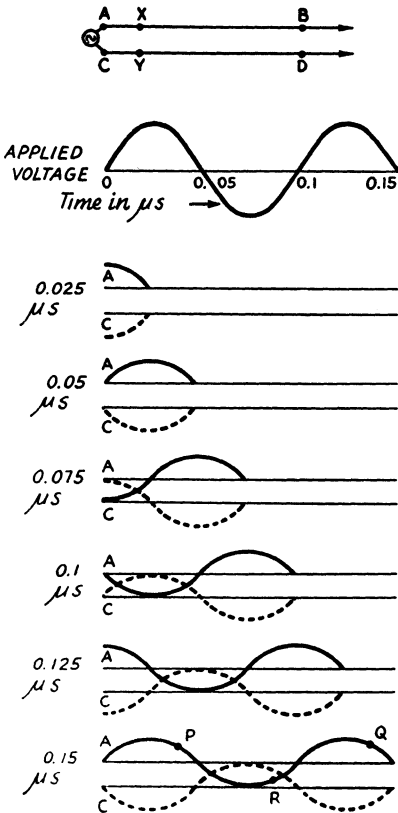

Fig. 3-4 — Instantaneous current along a transmission line at successive time intervals. The frequency is such that the time of one cycle is 0.1 microsecond.

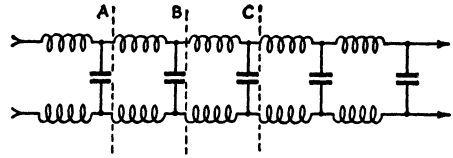

Fig. 3-5 — Equivalent of a transmission line in terms of ordinary circuit constants. The values of *L* and *C* depend on the line construction.

light. The actual velocity is very close to that of light in a line in which the insulation between conductors is solely air. The presence of dielectrics other than air reduces the velocity, since electromagnetic waves travel more slowly in dielectrics than they do in a vacuum. Because of this the wavelength as measured along the line will depend on the velocity factor that applies in the case of the particular type of line in use. (See later section in this chapter for actual figures.) The wavelength in a practical line is always shorter than the wavelength in free space.

**CHARACTERISTIC IMPEDANCE**

If this is a “perfect” line — one without resistance — a question immediately comes up: What is the amplitude of the current in the pulse? Will a larger voltage result in a larger current, or is the current theoretically infinite for any applied voltage, as we would expect from applying Ohm’s Law to a circuit without resistance? The answer is that the current does depend directly on the voltage, just as though resistance were present.

The reason for this is that the current flowing in the line is something like the charging current that flows when a battery is connected to a capacitor. That is, the line has capacitance. However, it also has inductance. Both of these are “distributed” properties. We may think of the line as being composed of a whole series of small inductors and capacitors connected as in Fig. 3-5, where each coil is the inductance of an extremely small section of wire and the capacitance is that existing between the same two sections. Each inductance limits the rate at which each immediately following capacitor can be charged, and the effect of the chain is to establish a definite relationship between current and voltage. Thus the line has an apparent “resistance,” called its characteristic resistance — or, a more general term, its characteristic impedance or surge impedance. The conventional symbol for characteristic impedance is  $Z_0$ .

**TERMINATED LINES**

The value of the characteristic impedance is equal to  $\sqrt{L/C}$  in a perfect line — i.e., one in which the conductors have no resistance and there is no leakage between them — where *L* and *C* are the inductance and capacitance, respectively, per unit length of line. The inductance decreases with increasing conductor diameter, and the capacitance decreases with increasing spacing between the

conductors. Hence a line with large conductors closely spaced will have relatively low characteristic impedance, while one with thin conductors widely spaced will have high impedance. Practicable values of  $Z_0$  for parallel-conductor lines range from about 200 to 800 ohms and for typical coaxial lines from 50 to 100 ohms.

### Matched Lines

In this picture of current traveling along a transmission line we have assumed that the line was infinitely long. Practical lines have a definite length, and they are connected to or terminated in a load at the "output" end, or end to which the power is delivered. If the load is a pure resistance of a value equal to the characteristic impedance of the line, Fig. 3-6, the current traveling along the line to the load does not find conditions changed in the least when it meets the load; in fact, the load just "looks like" still more transmission line of the same characteristic impedance.

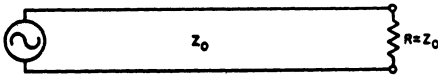

Fig. 3-6 — A transmission line terminated in a resistive load equal to the characteristic impedance of the line.

The reason for this can perhaps be made a little clearer by considering it from another viewpoint. In flowing along a transmission line, the power is handed from one of the elementary sections in Fig. 3-5 to the next. When the line is infinitely long this power transfer always goes on in one direction — away from the source of power. From the standpoint of section *B*, Fig. 3-5, for instance, the power it has handed over to section *C* has simply disappeared in *C*. So far as section *B* is concerned, it makes no difference whether *C* has absorbed the power itself or has in turn handed it along to more line. Consequently, if we substitute something for section *C* that has the same electrical characteristics, section *B* will not know the difference. A pure resistance equal to the characteristic impedance of *C*, which is also the characteristic impedance of the line, meets this condition. It absorbs all the power just as the infinitely long line absorbs all the power transferred by section *B*.

A line terminated in a purely resistive load equal to the characteristic impedance is said to be matched. In a matched transmission line, power travels outward along the line from the source until it reaches the load, where it is completely absorbed. Thus with either the infinitely long line or its matched counterpart the impedance presented to the source of power (the line-input impedance) is the same regardless of the line length. It is simply equal to the characteristic impedance of the line. The current in such a line is equal to the applied voltage divided by the characteristic impedance, and the power put into it is  $E^2/Z_0$  or  $I^2 Z_0$ , by Ohm's Law.

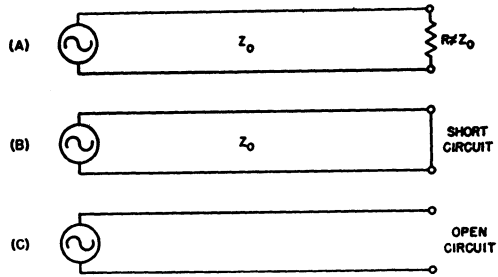

Fig. 3-7 — Mismatched lines. A — termination not equal to  $Z_0$ ; B — short-circuited line; C — open-circuited line.

### Mismatched Lines

Now take the case where the terminating resistance,  $R$ , is *not* equal to  $Z_0$ , as in Fig. 3-7. The load  $R$  no longer "looks like" more line to the section of line immediately adjacent. Such a line is said to be mismatched. The more  $R$  differs from  $Z_0$ , the greater the mismatch. The power reaching  $R$  is not totally absorbed, as it was when  $R$  was equal to  $Z_0$ , because  $R$  requires a different voltage-to-current ratio than the one at which the power is traveling along the line. The result is that  $R$  absorbs only part of the power reaching it (the incident power); the remainder acts as though it had bounced off a wall and starts back along the line toward the source. This is **reflected power** and the greater the mismatch the larger the percentage of the incident power that is reflected. In the extreme case where  $R$  is zero (a short circuit) or infinity (an open circuit) *all* of the power reaching the end of the line is reflected.

Whenever there is a mismatch, power is traveling in both directions along the line. The voltage-to-current ratio is the same for the reflected power as for the incident power, since this ratio is determined by the  $Z_0$  of the line. The voltage and current travel along the line in both directions in the same sort of wave motion shown in Fig. 3-4. When the source of power is an ac generator, the outgoing or incident voltage and the returning or reflected voltage are simultaneously present all along the line, so the actual voltage at any point along the line is the sum of the two components, taking phase into account. The same thing is true of the current.

The effect of the incident and reflected components on the behavior of the line can be understood more readily by considering first the two limiting cases — the short-circuited line and the open-circuited line. If the line is short-circuited as in Fig. 3-7B, the voltage at the end must be zero. Thus the incident voltage must disappear suddenly at the short. It can do this only if the reflected voltage is opposite in phase and of the same amplitude. This is shown by the vectors in Fig. 3-8. The current, however, does not disappear in the short circuit; in fact, the incident current flows through the short and there is in addition the reflected component in phase with it and of the same amplitude. The reflected voltage and current

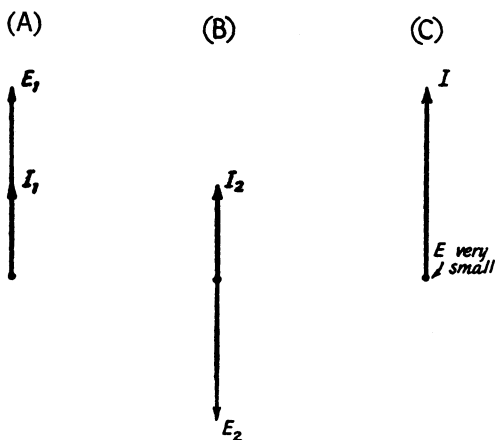

Fig. 3-8 — Voltage and current at the short circuit on a short-circuited line. These vectors show how the outgoing voltage and current (A) combine with the reflected voltage and current (B) to result in high current and very low voltage in the short-circuit (C).

must have the same amplitudes as the incident voltage and current because no power is used up in the short circuit; all the power starts back toward the source. Reversing the phase of *either* the current or voltage (but not both) will reverse the direction of power flow; in the short-circuited case the phase of the voltage is reversed on reflection but the phase of the current is not.

If the line is open-circuited (Fig. 3-7C) the current must be zero at the end of the line. In this case the reflected current is 180 degrees out of phase with the incident current and has the same amplitude. By reasoning similar to that used in the short-circuited case, the reflected voltage must be in phase with the incident voltage, and must have

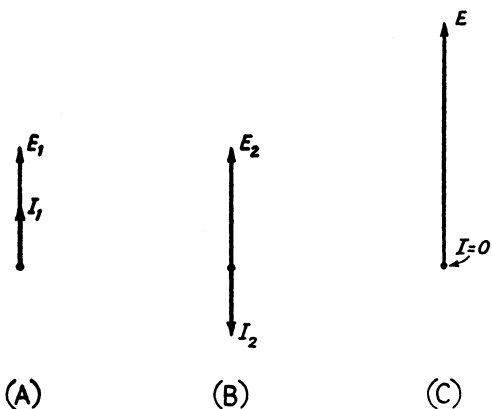

Fig. 3-9 — Voltage and current at the end of an open-circuited line. A — outgoing voltage and current; B — reflected voltage and current; C — resultant.

the same amplitude. Vectors for the open-circuited case are shown in Fig. 3-9.

Where there is a finite value of resistance at the end of the line, Fig. 3-7A, only part of the power reaching the end of the line is reflected. That is, the reflected voltage and current are smaller than the incident voltage and current. If  $R$  is less than  $Z_0$  the reflected and incident voltages are 180 degrees out of phase, just as in the case of the short-circuited line, but the amplitudes are not equal because all of the voltage does not disappear at  $R$ . Similarly, if  $R$  is greater than  $Z_0$  the reflected and incident currents are 180 degrees out of phase, as they were in the open-circuited line, but all of the current does not disappear in  $R$  so the amplitudes of the two components are not equal. These two cases are shown in Fig. 3-10. Note that the resultant current and voltage are in phase in  $R$ , since  $R$  is a pure resistance.

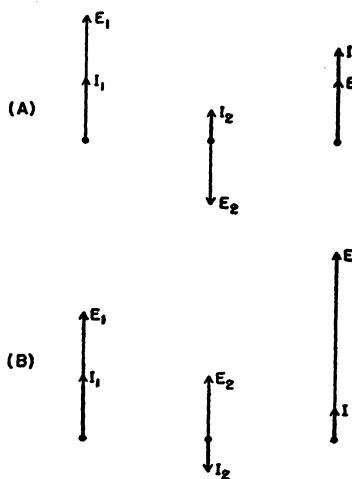

Fig. 3-10 — Incident and reflected components of voltage and current when the line is terminated in a pure resistance not equal to  $Z_0$ . In the case shown, the reflected components have half the amplitude of the incident components. A —  $R$  less than  $Z_0$ ; B —  $R$  greater than  $Z_0$ .

### Reflection Coefficient

The ratio of the reflected voltage to the incident voltage is called the **reflection coefficient**. Thus

$$\rho = \frac{E_r}{E_f}$$

where  $\rho$  is the reflection coefficient,  $E_r$  is the reflection voltage, and  $E_f$  is the incident or forward voltage. The reflection coefficient is determined by the relationship between the line  $Z_0$  and the actual load at the terminated end of the line. For any given line and load it is a constant if the line has negligible loss in itself. The coefficient can never be larger than 1 (which indicates that all the incident power is reflected) nor smaller than zero (indicating that the line is perfectly matched by the load).



If the load is purely resistive, the reflection coefficient can be found from

$$\rho = \frac{R - Z_0}{R + Z_0}$$

where  $R$  is the resistance of the load terminating the line. In this expression  $\rho$  is positive if  $R$  is larger than  $Z_0$  and negative if  $R$  is smaller than  $Z_0$ . The change in signs accompanies the change in phase of the reflected voltage described above.

### STANDING WAVES

As might be expected, reflection cannot occur at the load without some effect on the voltages and currents all along the line. A detailed description tends to become complicated, and what happens is most simply shown by vector diagrams, Fig. 3-11 is an example in the case where  $R$  is less than  $Z_0$ . The voltage and current vectors at the load,  $R$ , are shown in the reference position; they correspond with the vectors in Fig. 3-10A. Going back along the line from  $R$  towards the power source, the

against position along the line, graphs like those of Fig. 3-12 will result. If we could go along the line with a voltmeter and ammeter plotting the current and voltage at each point, we should find that the data collected gave curves like these. In contrast, if the load matched the  $Z_0$  of the line, similar measurements along the line would show that the voltage is the same everywhere (and similarly for the current). The mismatch between load and line is responsible for the variations in amplitude which, because of their wave-like appearance, are called standing waves.

From the earlier discussion it should be clear that when  $R$  is greater than  $Z_0$ , the voltage will be largest and the current smallest at the load. This is just the reverse of the case shown in Fig. 3-12. In such case the curve labeled  $E$  would become the  $I$  (current) curve, while the current curve would become the voltage curve.

Some general conclusions can be drawn from inspection of the standing-wave curves: At a position 180 degrees ( $1/2$  wavelength) from the load, the voltage and current have the same values

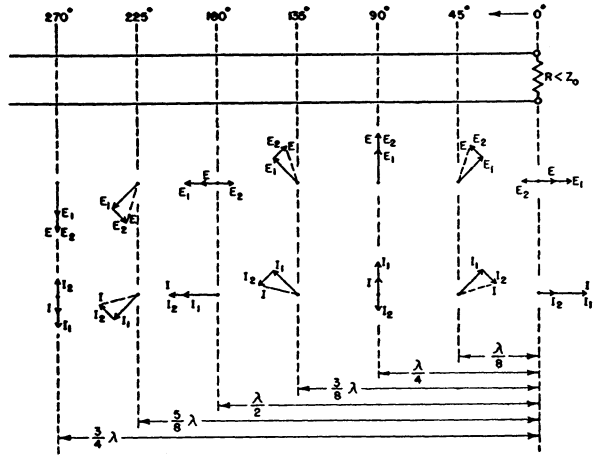

Fig. 3-11 — Incident and reflected components at various positions along the line, together with resultant voltages and currents at the same positions. The case shown is for  $R$  less than  $Z_0$ .

incident vectors,  $E_1$  and  $I_1$ , lead the vectors at the load according to their position along the line measured in electrical degrees. (The corresponding distances in fractions of a wavelength also are shown.) The vectors representing reflected voltage and current,  $E_2$  and  $I_2$ , successively lag the same vectors at the load. This lag and lead is the natural consequence of the direction in which the incident and reflected components are traveling, together with the fact that it takes time for the power to travel along the line. The resultant voltage,  $E$ , and current,  $I$ , at each of these positions are shown dotted. Although the incident and reflected components maintain their respective amplitudes (the reflected component is shown at half the incident-component amplitude in this drawing) their phase relationships vary with position along the line. The phase shifts cause both the amplitude and phase of the resultants to vary with position on the line.

If the amplitude variations (disregarding phase) of the resultant voltage and current are plotted

they do at the load. At a position 90 degrees from the load the voltage and current are "inverted." That is, if the voltage is lowest and the current highest at the load ( $R$  less than  $Z_0$ ), then 90 degrees or  $1/4$  wavelength from the load the voltage reaches its highest value and the current reaches its lowest value. In the case where  $R$  is greater than  $Z_0$ , so that the voltage is highest and the current lowest at the load, the voltage has its lowest value and the current its highest value at a point 90 degrees from the load.

Note that the conditions existing at the 90-degree point also are duplicated at the 270-degree point ( $3/4$  wavelength). If the graph were continued on toward the source of power it would be found that this duplication occurs at every point that is an odd multiple of 90 degrees (odd multiple of a quarter wavelength) from the load. Similarly, the voltage and current are the same at every point that is a multiple of 180 degrees (any multiple of one-half wavelength) as they are at the load.

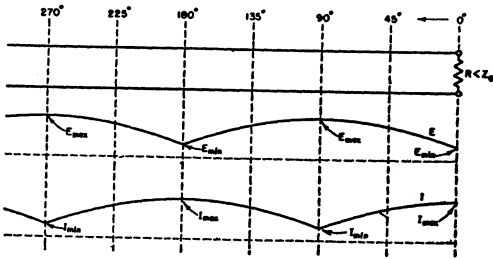

Fig. 3-12 - Standing waves of current and voltage along the line, for  $R$  less than  $Z_0$ .

**Standing-Wave Ratio**

The ratio of the maximum voltage along the line to the minimum voltage - that is, the ratio of  $E_{max}$  to  $E_{min}$  in Fig. 3-12 - is called the **voltage standing-wave ratio** (abbreviated VSWR) or simply the **standing-wave ratio (SWR)**. The ratio of the maximum current to the minimum current ( $I_{max}/I_{min}$ ) is the same as the VSWR, so either current or voltage can be measured to determine the standing-wave ratio.

The standing-wave ratio is an index of many of the properties of a mismatched line. It can be measured with good accuracy with fairly simple equipment, and so is a convenient quantity to use in making calculations on line performance. If the load contains no reactance, the SWR is numerically equal to the ratio between the load resistance,  $R$ , and the characteristic impedance of the line; that is,

$$SWR = \frac{R}{Z_0}$$

when  $R$  is greater than  $Z_0$ , and

$$SWR = \frac{Z_0}{R}$$

when  $R$  is less than  $Z_0$ . The smaller quantity is always used in the denominator of the fraction so the SWR will be a number larger than 1.

This relationship shows that the greater the mismatch - that is, the greater the difference between  $Z_0$  and  $R$  - the larger the SWR. In the case of open- and short-circuited lines the SWR becomes infinite. On such lines the voltage and current become zero at the minimum points ( $E_{min}$  and  $I_{min}$ ) since total reflection occurs at the end of the line and the incident and reflected components have equal amplitudes.

**INPUT IMPEDANCE**

The relationship between the voltage and current at any point along the line (including the effects of both the incident and reflected components) becomes more clear when only the resultant voltage and current are shown, as in Fig. 3-13. Note that the voltage and current are in phase not only at the load but also at the 90-degree point, the 180-degree point, and the 270-degree point. This is also true at every point that is a multiple of 90 degrees from the load.

Suppose the line were cut at one of these points and the generator or source of power were connected to that portion terminated in  $R$ . Then the generator would "see" a pure resistance, just as it would if it were connected directly to  $R$ . However, the value of the resistance it sees would depend on the line length. If the length is 90 degrees, or an odd multiple of 90 degrees, where the voltage is high and the current low, the resistance seen by the generator would be greater than  $R$ . If the length is 180 degrees or a multiple of 180 degrees, the voltage and current relationships are the same as in  $R$ , and therefore the generator "sees" a resistance equal to the actual load resistance at these line lengths.

The current and voltage are exactly in phase only at points that are multiples of 90 degrees

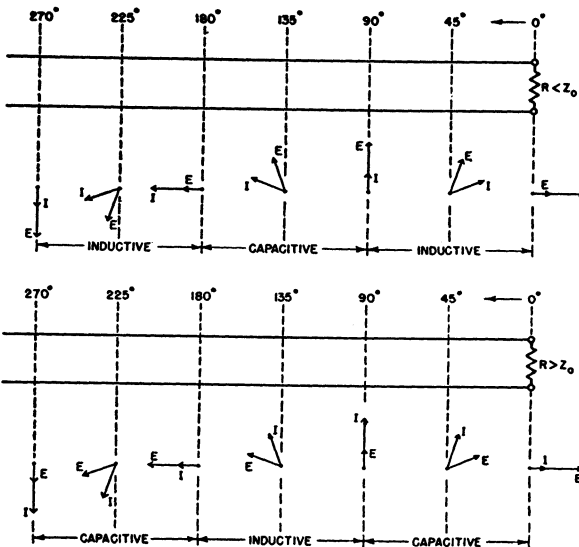

Fig. 3-13 - Resultant voltages and currents along a mismatched line. Above -  $R$  less than  $Z_0$ ; below -  $R$  greater than  $Z_0$ .

from the load. At all other points the current either leads or lags the voltage, and so the load seen by the generator when the line length is not an exact multiple of 90 degrees is not a pure resistance. The input impedance of the line – that is, the impedance seen by the generator connected to the line – in such a case has both resistive and reactive components. When the current lags behind the voltage the reactance is inductive; when it leads the voltage the reactance is capacitive. The upper drawing in Fig. 3-13 shows that when the line is terminated in a resistance smaller than  $Z_0$  the reactance is inductive in the first 90 degrees of line moving from the load toward the generator, is capacitive in the second 90 degrees, inductive in the third 90 degrees, and so on every 90 degrees or quarter wavelength. The lower drawing illustrates the case where  $R$  is greater than  $Z_0$ . The voltage and current vectors are merely interchanged, since, as explained in connection with Fig. 3-11, in this case the vector for the reflected current is the one that is reversed in phase on reflection. The reactance becomes capacitive in the first 90 degrees, inductive in the second, and so on.

**Factors Determining the Input Impedance**

The magnitude and phase angle of the input impedance depend on the SWR, the line length, and the  $Z_0$  of the line. If the SWR is small, the input impedance is principally resistive at all line lengths; if the SWR is high, the reactive component may be relatively large. The input impedance of the line can be represented by a series circuit of resistance and reactance, as shown in Fig. 3-14 where  $R_s$  is the resistive component and  $X_s$  is the reactive component. Frequently the “s” subscripts are omitted, and the series-equivalent impedance denoted as  $R + jX$ . The  $j$  is an operator function, used to indicate that the values for  $R$  and  $X$  cannot be added directly, but that vector addition must be used if the overall impedance is to be determined. (This is analogous to solving a right triangle for the length of its hypotenuse, where  $R$  and  $X$  represent the length of its two sides. The length of the hypotenuse represents  $Z$ , the overall impedance.) By convention, a plus sign is assigned to  $j$  when the reactance is inductive ( $R + jX$ ), and a minus sign is used when the reactance is capacitive ( $R - jX$ ).

**Equivalent Circuits for the Input Impedance**

The series circuits shown in Fig. 3-14 are equivalent to the actual input impedance of the line because they have the same total impedance and the same phase angle. It is also possible to form a circuit with resistance and reactance in parallel that will have the same total impedance and phase angle as the line. This equivalence is shown in Fig. 3-15. The individual values in the parallel circuit are not the same as those in the series circuit (although the overall result is the same) but are related to the series-circuit values by the equations shown in the drawing.

Either of the two equivalent circuits may be used, depending on which happens to be more convenient for the particular purpose. These cir-

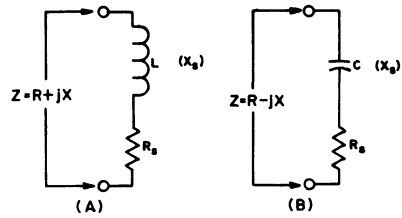

Fig. 3-14 – Series circuits which may be used to represent the input impedance of a length of transmission line.

cuits are important from the standpoint of designing coupling networks so that the desired amount of power will be taken from the source. Their practical application is described later in this chapter.

**REACTIVE TERMINATIONS**

So far the only type of load considered has been a pure resistance. In general, the actual load usually will be fairly close to being a pure resistance, since most transmission lines used by amateurs are connected to resonant antenna systems, which are principally resistive in nature. Consequently, the resistive load is an important practical case.

However, an antenna system is purely resistive only at one frequency, and when it is operated over a band of frequencies without readjustment – the usual condition – its impedance will contain a

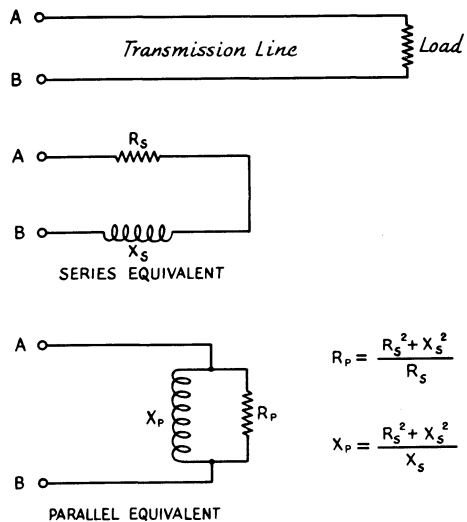

Fig. 3-15 – Input impedance of a line terminated in a pure resistance. The input impedance can be represented either by a resistance and reactance in series or a resistance and reactance in parallel. The relationship between the  $R$  and  $X$  values in the series and parallel equivalents is given by the formulas.  $X$  may be either inductive or capacitive, depending on the line length,  $Z_0$ , and the load.

certain amount of reactance along with resistance. The effect of such a combination is to increase the standing-wave ratio — that is, as between two loads, one having only resistance of, say, 100 ohms as compared with a reactive load having the same total impedance, 100 ohms, the SWR will be higher with the reactive load than with the purely resistive load. Also as between two loads containing the same value of resistance but one being without reactance while the other has a reactive component in addition, the SWR will be higher with the one having the reactance.

The effect of reactance in the load is to shift the phase of the current with respect to the voltage both in the load itself and in the reflected components of voltage and current. This in turn causes a shift in the phase of the resultant current with respect to the resultant voltage. The net result is to shift the points along the line at which the various effects already described will occur. With a load having inductive reactance the point of maximum voltage and minimum current is shifted toward the load. The reverse occurs when the reactance in the load is capacitive.

### SMITH-CHART TRANSMISSION-LINE CALCULATIONS

It has already been stated that the input impedance, or the impedance seen when “looking into” a length of line, is dependent upon the SWR, the length of the line, and the  $Z_0$  of the line. The SWR, in turn, is dependent upon the load which terminates the line. There are complex mathematical relationships which may be used to calculate the various values of impedances, voltages, currents, and SWR values which exist in the operation of a particular transmission line. However, it is much easier to determine such parameters graph-

ically, with the aid of a very useful device, the Smith Chart. If the terminating impedance is known, it is a simple matter to determine the input impedance of the line for any length by means of the Chart. Conversely, with a given line length and a known (or measured) input impedance, the load impedance may be determined by means of the Chart — a convenient method of remotely determining an antenna impedance, for example.

Named after its inventor, Phillip H. Smith, the Smith Chart was originally described in *Electronics* for January, 1939. Smith charts may be obtained at most university book stores. They may be ordered (50 for \$2.50, postpaid when remittance is enclosed) from Phillip H. Smith, Analog Instruments Co., P. O. Box 808, New Providence, NJ 07974. For 8-1/2 × 11-inch paper charts with normalized coordinates, request Form 82-BSPR. Smith charts with 50-ohm coordinates (Form 5301-7569) are available at the same price from General Radio Co., West Concord, MA 01781.

Although its appearance may at first seem somewhat formidable, the Smith Chart is really nothing more than a specialized type of graph, with curved, rather than rectangular, coordinate lines. The coordinate system consists simply of two families of circles — the resistance family and the reactance family. The resistance circles (Fig. 3-16) are centered on the resistance axis (the only straight line on the Chart), and are tangent to the outer circle at the bottom of the Chart. Each circle is assigned a value of resistance, which is indicated at the point where the circle crosses the resistance axis. All points along any one circle have the same resistance value.

The values assigned to these circles vary from zero at the top of the chart to infinity at the bottom, and actually represent a ratio with respect to the impedance value assigned to the center point of the Chart, indicated 1.0. This center point is called **prime center**. If prime center is assigned a value of 100 ohms, then 200 ohms resistance is represented by the 2.0 circle, 50 ohms by the 0.5 circle, 20 ohms by the 0.2 circle, and so on. If a value of 50 is assigned to prime center, the 2.0 circle now represents 100 ohms, the 0.5 circle 25 ohms, and the 0.2 circle 10 ohms. In each case, it may be seen that the value on the Chart is determined by dividing the actual resistance by the number assigned to prime center. This process is called **normalizing**. Conversely, values from the Chart are converted back to actual resistance values by multiplying the Chart value times the value assigned to prime center. This feature permits the use of the Smith Chart for any impedance values, and therefore with any type of uniform transmission line, whatever its impedance may be. As mentioned above, specialized versions of the Smith Chart may be obtained with a value of 50 ohms at prime center. These are intended for use with 50-ohm lines.

Now consider the reactance circles (Fig. 3-17) which appear as curved lines on the Chart because only segments of the complete circles are drawn. These circles are tangent to the resistance axis, which itself is a member of the reactance family

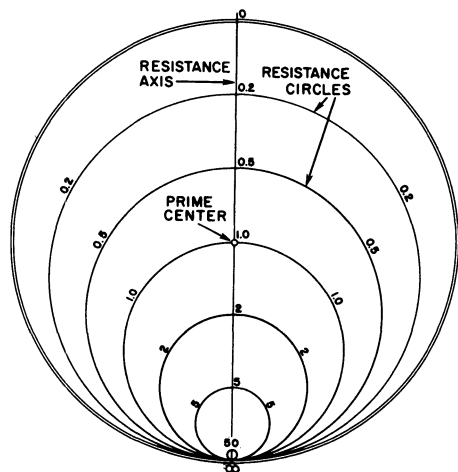

Fig. 3-16 — Resistance circles of the Smith Chart coordinate system.

(with a radius of infinity). The centers are displaced to the right or left on a line tangent to the bottom of the chart. The large outer circle bounding the coordinate portion of the Chart is the reactance axis.

Each reactance circle segment is assigned a value of reactance, indicated near the point where the circle touches the reactance axis. All points along any one segment have the same reactance value. As with the resistance circles, the values assigned to each reactance circle are normalized with respect to the value assigned to prime center. Values to the right of the reactance axis are positive (inductive), and those to the left of the reactance axis are negative (capacitive).

When the resistance family and the reactance family of circles are combined, the coordinate system of the Smith Chart results, as shown in Fig. 3-18. Complex series impedances can be plotted on this coordinate system.

### Impedance Plotting

Suppose we have an impedance consisting of 50 ohms resistance and 100 ohms inductive reactance ( $Z = 50 + j100$ ). If we assign a value of 100 ohms to prime center, we normalize the above impedance by dividing each component of the impedance by 100. The normalized impedance would then be  $\frac{50}{100} + j\frac{100}{100} = 0.5 + j1.0$ . This impedance would be plotted on the Smith Chart at the intersection of the 0.5 resistance circle and the +1.0 reactance circle, as indicated in Fig. 3-18. If a value of 50 ohms had been assigned to prime center, as for 50-ohm coaxial line, the same impedance would be plotted at the intersection of the  $\frac{50}{50} = 1.0$  resistance circle, and the  $\frac{100}{50} = 2.0$  positive reactance circle, or at  $1 + j2$  (also indicated in Fig. 3-18).

From these examples, it may be seen that the same impedance may be plotted at different points on the Chart, depending upon the value assigned to prime center. It is customary when solving transmission-line problems to assign to prime center a value equal to the characteristic impedance, or  $Z_0$ , of the line being used. This value should always be recorded at the start of calculations, to avoid possible confusion later. In using the specialized charts with the value of 50 at prime center, it is, of course, not necessary to normalize impedances when working with 50-ohm line. The resistance and reactance values may be plotted directly.

### Short and Open Circuits

On the subject of plotting impedances, two special cases deserve consideration. These are short circuits and open circuits. A true short circuit has zero resistance and zero reactance, or  $0 + j0$ . This impedance would be plotted at the top of the Chart, at the intersection of the resistance and the reactance axes. An open circuit has infinite resistance, and would therefore be plotted at the

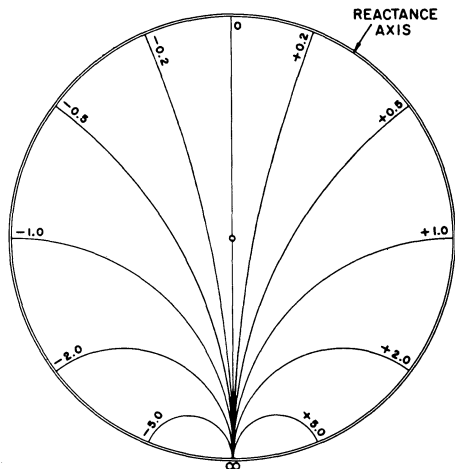

Fig. 3-17 – Reactance circles (segments) of the Smith Chart coordinate system.

bottom of the Chart, at the intersection of the resistance and reactance axes. These two special cases are sometimes used in matching stubs, described later in this chapter.

### Standing-Wave-Ratio Circles

Members of a third family of circles, which are not printed on the chart but which are added during the process of solving problems, are **standing-wave-ratio** or **SWR** circles. See Fig. 3-19. This family is centered on prime center, and appears as concentric circles inside the reactance axis. During calculations, one or more of these circles may be added with a drawing compass. Each circle repre-

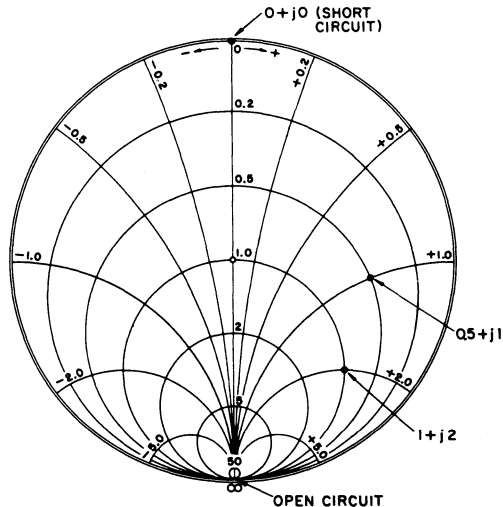

Fig. 3-18 – The complete coordinate system of the Smith Chart. For simplicity, only a few divisions are shown for the resistance and reactance values.

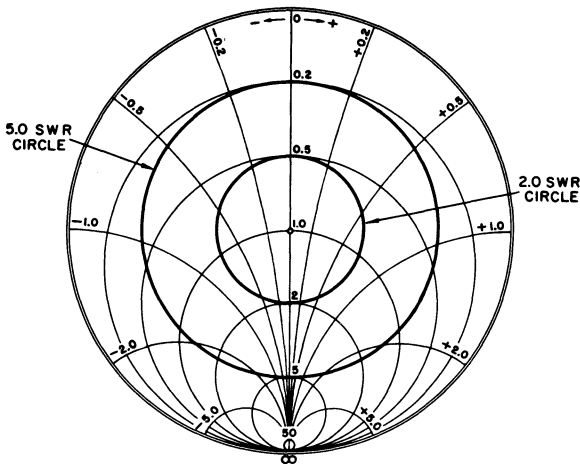

Fig. 3-19 — Smith Chart with SWR circles added.

sents a value of SWR, every point on a given circle representing the same SWR. The SWR value for a given circle may be determined directly from the chart coordinate system, by reading the resistance value where the SWR circle crosses the resistance axis, below prime center. (The reading where the circle crosses the resistance axis above prime center indicates the inverse ratio.)

Consider the situation where a load mismatch in a length of line causes a 3-to-1 standing-wave ratio to exist. If we temporarily disregard line losses, we may state that the SWR remains constant throughout the entire length of this line. This is represented on the Smith Chart by drawing a 3:1 constant-SWR circle (a circle with a radius of 3 on the resistance axis), as in Fig. 3-20. The design of the Chart is such that any impedance encountered anywhere along the length of this mismatched line will fall on the SWR circle, and may be read from the coordinates merely by progressing around the SWR circle by an amount corresponding to the length of the line involved.

This brings into use the wavelength scales, which appear, in Fig. 3-20, near the outer perimeter of the Smith Chart. These scales are calibrated in terms of portions of an electrical wavelength along a transmission line. One scale, running counterclockwise, starts at the generator or input end of the line and progresses toward the load, while the other scale starts at the load and proceeds toward the generator in a clockwise direction. The complete circle represents one half wavelength. The complete circle represents one half wavelength. Progressing once around the perimeter of these scales corresponds to progressing along a transmission line for a half wavelength. Because impedances will repeat themselves every half wavelength along a piece of line, the Chart may be used for any length of line by disregarding or subtracting from the line's total length an integral, or whole number, of half wavelengths.

Also shown in Fig. 3-20 is a means of transferring the radius of the SWR circle to the external

scales of the chart, by drawing lines tangent to the circle. Or, the radius of the SWR circle may be simply transferred to the external scale by placing the point of a drawing compass at the center, or 0, line and inscribing a short arc across the appropriate scale. It will be noted that when this is done in Fig. 3-20, the external STANDING-WAVE VOLTAGE-RATIO scale indicates the SWR to be 3.0 (at A) — our condition for initially drawing the circle on the Chart (and the same as the SWR reading on the resistance axis).

### Solving Problems with the Smith Chart

Suppose we have a transmission line with a characteristic impedance of 50 ohms, and an electrical length of 0.3 wavelength. Also, suppose we terminate this line with an impedance having a resistive component of 25 ohms and an inductive reactance of 25 ohms ( $Z = 25 + j25$ ), and desire to determine the input impedance to the line. Because the line is not terminated in its characteristic impedance, we know that standing waves will be present on the line, and that, therefore, the input impedance to the line will not be exactly 50 ohms. We proceed as follows: First, normalize the load impedance by dividing both the resistive and reactive components by 50 ( $Z_0$  of the line being used). The normalized impedance in this case is  $0.5 + j0.5$ . This is plotted on the Chart at the intersection of the 0.5 resistance and the  $+0.5$  reactance circles, as in Fig. 3-21. Then draw a constant-SWR circle passing through this plotted point. The radius of this circle may then be transferred to the external scales with the drawing compass. From the external S.W.V.R. scale, it may be seen (at A), that the voltage ratio of 2.6 exists for this radius, indicating that our line is operating with an SWR of 2.6 to 1. This figure is converted to decibels in the adjacent scale, where 8.4 dB may be read (at B), indicating that the ratio of the voltage maximum to the voltage minimum along the line is 8.4 dB.

Next, with a straightedge, draw a radial line from prime center through the plotted point to intersect the wavelengths scale, and read a value from the wavelengths scale. Because we are starting from the load, we use the TOWARD-GENERATOR or outermost calibration, and read 0.088 wavelength (at C). To obtain the line input impedance, we merely find the point on the SWR circle which is 0.3 wavelength toward the generator from the plotted load impedance. This is accomplished by adding 0.3 (the length of the line in wavelengths) to the reference or starting point,  $0.088$ ;  $0.3 + 0.088 = 0.388$ . Locate 0.388 on the TOWARD-GENERATOR scale (at D), and draw a second radial line from this point to prime center. The intersection of the new radial line with the SWR circle represents the line input impedance, in this case  $0.6 - j0.65$ . To find the actual line input

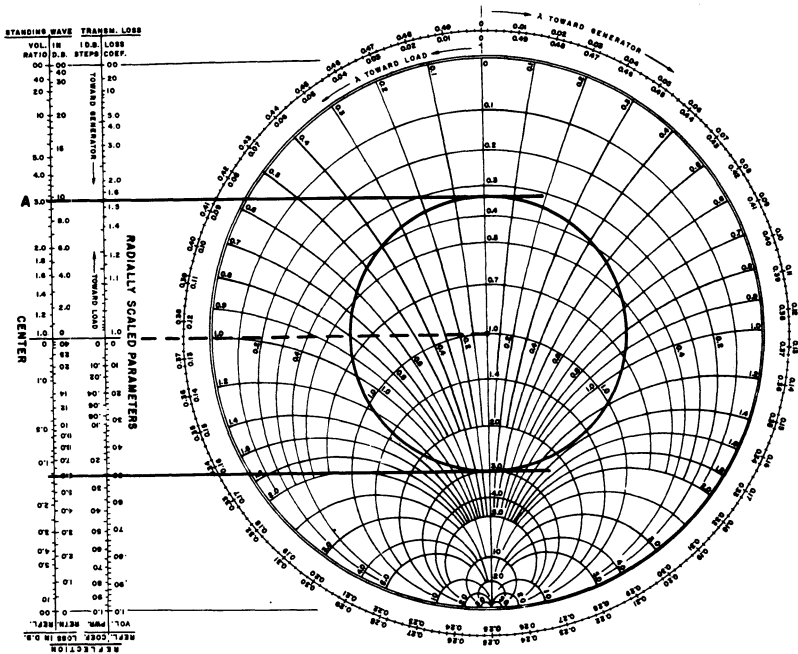

Fig. 3-20 – Example discussed in text.

impedance, multiply by 50 – the value assigned to prime center, which equals  $30 - j32.5$ , or 30 ohms resistance and 32.5 ohms capacitive reactance. This is the impedance which a transmitter must match if such a system were a combination of antenna and transmission line, or is the impedance which would be measured on an impedance bridge if the measurement were taken at the line input.

In addition to the line input impedance and the SWR, the Chart reveals several other operating characteristics of the above system of line and load, if a closer look is desired. For example, the voltage reflection coefficient, both magnitude and phase angle, for this particular load is given. The phase angle is read under the radial line drawn through the plot of the load impedance where the line intersects the ANGLE-OF-REFLECTION-COEFFICIENT scale. This scale is not included in Fig. 3-21, but will be found on the Smith Chart, just inside the wavelengths scales. In this example, the reading would be about 116.5 degrees. This indicates the angle by which the reflected voltage wave lags the incident wave at the load. It will be noted that angles on the left half, or capacitive-reactance side, of the Chart are negative angles, a “negative” lag indicating that the reflected voltage wave actually leads the incident wave.

The magnitude of the voltage-reflection-coefficient may be read from the external REFLECTION-COEFFICIENT-VOLTAGE scale, and is seen to be approximately 0.44 (at E) for this example, meaning 44 percent of the incident voltage is reflected. Adjacent to this scale on the POWER calibration, it is noted (at F) that the power reflection coefficient is 0.20, indicating that 20 percent of the incident power would be

reflected. (The amount of reflected power is proportional to the square of the reflected voltage.)

### Admittance Coordinates

Quite often it is desirable to convert impedance information to admittance data – conductance and susceptance. Working with admittances greatly simplifies determining the resultant when two complex impedances are connected in parallel, as in stub matching. The conductance values may be added directly, as may be the susceptance values, to arrive at the overall admittance for the parallel combination. This admittance may then be converted back to impedance data.

On the Smith Chart, the necessary conversion may be made very simply. The equivalent admittance of a plotted impedance value lies diametrically opposite the impedance point on the Chart. In the foregoing example, where the normalized line input impedance is  $0.6 - j0.65$ , the equivalent admittance lies at the intersection of the SWR circle and the extension of the straight line passing from point D to prime center. Although not shown in Fig. 3-21, the normalized admittance value may be read as  $0.76 + j0.84$  if the line is extended. (Capacitance is considered to be a positive susceptance and inductance a negative susceptance.) The admittance in mhos is determined by dividing the normalized values by the  $Z_0$  of the line. For this example the admittance would be  $0.76/50 + j0.84/50 = 0.0152 + j0.0168$  mho.

Of course admittance coordinates may be converted to impedance coordinates just as easily – by locating the point on the Smith Chart which is

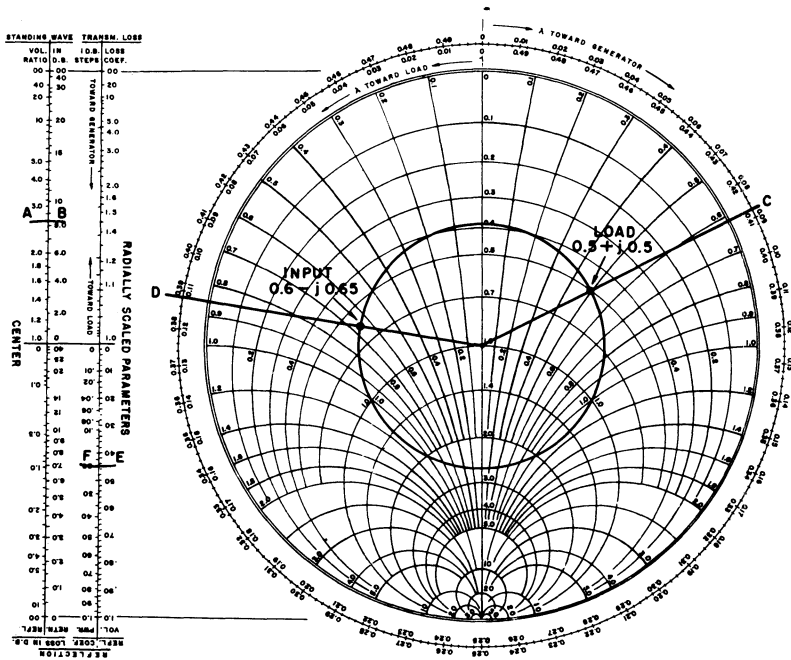

Fig. 3-21 — Example discussed in text.

diametrically opposite the point representing the admittance coordinates, on the same SWR circle.

#### Determining Actual Antenna Impedances

To determine an actual antenna impedance from the Smith Chart, the procedure is similar to the previous example. The electrical length of the feed line must be known and the impedance value at the input end of the line must be determined through measurement, such as with an impedance-measuring bridge like the Macromatcher, described in the Measurements chapter. In this case, the antenna is connected to the far end of the line and becomes the load for the line. Whether the antenna is intended purely for transmission of energy, or purely for reception makes no difference; the antenna is still the terminating or load impedance on the line as far as these measurements are concerned. The *input* or *generator* end of the line would be that end connected to the device for measurement of the impedance. In this type of problem, the measured impedance is plotted on the Chart, and the TOWARD-LOAD wavelengths scale is used in conjunction with the electrical line length to determine the actual antenna impedance.

For example, assume we have a measured input impedance to a 50-ohm line of  $70 - j25$  ohms. The line is 2.35 wavelengths long, and is terminated in an antenna. We desire to determine the actual antenna impedance. Normalize the input impedance with respect to 50 ohms, which comes out  $1.4 - j0.5$ , and plot this value on the Chart. See Fig. 3-22. Draw a constant-SWR circle through the point, and transfer the radius to the external scales.

The SWR of 1.7 may be read from the S.W.V.R. scale (at A). Now draw a radial line from prime center through this plotted point to the wavelengths scale, and read a reference value, which is 0.195 (at B), on the TOWARD-LOAD scale. Remember, we are starting at the *generator* end of the transmission line.

To locate the load impedance on the SWR circle, we add the line length, 2.35 wavelengths to the reference value from the wavelengths scale, and locate the new value on the TOWARD-LOAD scale;  $2.35 + 0.195 = 2.545$ . However, the calibrations extend only from 0 to 0.5, so we must subtract a whole number of half wavelengths from this value and use only the remaining value. In this situation, the largest integral number of half wavelengths that can be subtracted is 5, or 2.5 wavelengths. Thus,  $2.545 - 2.5 = 0.045$ , and the 0.045 value is located on the TOWARD-LOAD scale (at C). A radial line is then drawn from this value to prime center, and the coordinates at the intersection of the second radial line and the SWR circle represent the load impedance. To read this value closely, some interpolation between the printed coordinate lines must be made, and the value of  $0.62 - j0.18$  is read. Multiplying by 50, the actual load or antenna impedance is  $31 - j9$  ohms, or 31 ohms resistance with 9 ohms capacitive reactance.

Problems may be entered on the chart in yet another manner. Suppose we have a length of 50-ohm line feeding a base-loaded resonant vertical ground-plane antenna which is shorter than a quarter wave. Further, suppose we have an SWR



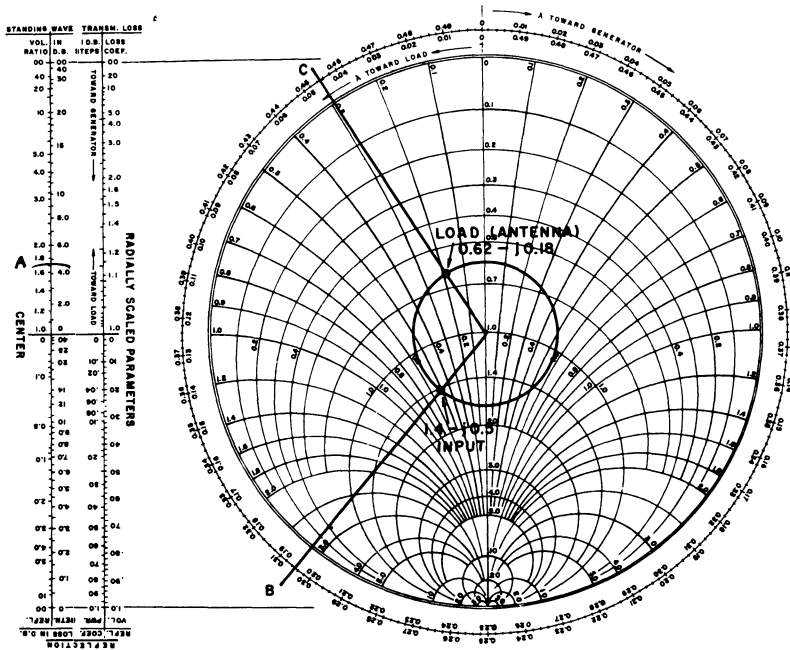

Fig. 3-22 – Example discussed in text.

monitor in the line, and that it indicates an SWR of 1.7 to 1. The line is known to be 0.95 wavelength long. We desire to know both the input and the antenna impedances.

From the data given, we have no impedances to enter onto the chart. We may, however, draw a circle representing the 1.7 SWR. We also know, from the definition of resonance, that the antenna presents a purely resistive load to the line; i.e., no reactive component. Thus, the antenna impedance must lie on the resistance axis. If we were to draw such an SWR circle and observe the Chart with only the circle drawn, we would see two points which satisfy the resonance requirement for the load. These points are  $0.59 + j0$  and  $1.7 + j0$ . Multiplying by 50, these values represent 29.5 and 85 ohms resistance. This may sound familiar, because, as was discussed earlier, when a line is terminated in a pure resistance, the SWR in the line equals  $Z_R/Z_0$  or  $Z_0/Z_R$ , where  $Z_R$  = load resistance and  $Z_0$  = line impedance.

If we consider antenna fundamentals described in Chapter Two, we know that the theoretical impedance of a quarter-wave ground-plane antenna is approximately 36 ohms. We therefore can quite logically discard the 85-ohm impedance figure in favor of the 29.5-ohm value. This is then taken as the actual load-impedance value for the Smith Chart calculations. The line input impedance is found to be  $0.64 - j0.21$ , or  $32 - j10.5$  ohms, after subtracting 0.5 wavelength from 0.95, and finding 0.45 wavelength on the TOWARD-GENERATOR scale. (The wavelength reference in this case is 0.)

### Determination of Line Length

In the example problems given so far in this section, the line length has conveniently been stated in wavelengths. The electrical length of a piece of line depends upon its physical length, the radio frequency under consideration, and the velocity of propagation in the line. If an impedance-measurement bridge is capable of quite reliable readings at high line-SWR values, the line length may be determined through line input-impedance measurements with short- or open-circuit terminations. A more direct method is to measure the line's physical length and apply the value to a formula. The formula is:

$$N = \frac{LF}{984K}$$

where

$N$  = Number of electrical wavelengths in the line,

$L$  = Line length in feet,

$F$  = Frequency in megahertz, and

$K$  = Velocity or propagation factor of the line.

The factor  $K$  may be obtained from transmission-line data tables which appear later in this chapter.

### ATTENUATION

The discussion in the preceding part of this chapter applies to all types of transmission lines, regardless of their physical construction. It is, however, based on the assumption that there is no power loss in the line. Every actual line will have

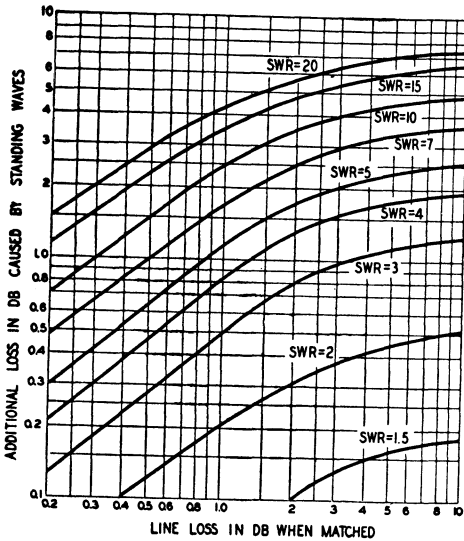

Fig. 3-23 — Increase in line loss because of standing waves (SWR measured at the load). To determine the total loss in decibels in a line having an SWR greater than 1, first determine the loss for the particular type of line, length and frequency, on the assumption that the line is perfectly matched (Table 3-1). Locate this point on the horizontal axis and move up to the curve corresponding to the actual SWR. The corresponding value on the vertical axis gives the additional loss in decibels caused by the standing waves.

some inherent loss, partly because of the resistance of the conductors, partly, because of the fact that power is consumed in every dielectric used for insulating the conductors, and partly because in many cases a small amount of power escapes from the line by radiation.

Losses in a line modify its characteristic impedance slightly, but usually not to a sufficient extent to be significant. They will also affect the input impedance; in this case the theoretical values will be modified only slightly if the line is short and has only a small loss, but may be changed considerably if an appreciable proportion of the power input to the line is dissipated by the line itself. A large loss may exist because the line is long, because it has inherently high loss per unit length, because the standing-wave ratio is high, or because of a combination of two or all three of these factors.

The reflected power returning to the input terminals of the line is less when the line has losses than it would be if there were none. The overall effect is that the SWR changes along the line, being highest at the load and smallest at the input terminals. A long, high-loss line therefore tends to act, so far as its input impedance is concerned, as though the impedance match at the load end were better than is actually the case.

#### Line Losses

The power lost in a transmission line is not directly proportional to the line length but varies

logarithmically with the length. That is, if 10% of the input power is lost in a section of line of certain length, 10% of the remaining power will be lost in the next section of the same length, and so on. For this reason it is customary to express line losses in terms of decibels per unit length, since the decibel is a logarithmic unit. Calculations are very simple because the total loss in a line is found by multiplying the dB loss per unit length by the total length of the line. Line loss is usually expressed in decibels per 100 feet. It is necessary to specify the frequency for which the loss applies, since the loss varies with frequency.

Conductor loss and dielectric loss both increase as the operating frequency is increased, but not in the same way. This, together with the fact that the relative amount of each type of loss depends on the actual construction of the line, makes it impossible to give a specific relationship between loss and frequency that will apply to all types of lines. Each line has to be considered individually. Actual loss values are given in a later section.

#### Effect of SWR

The power lost in a line is least when the line is terminated in a resistance equal to its characteristic impedance, and increases with an increase in the standing-wave ratio. This is because the effective values of both current and voltage become larger as the SWR becomes greater. The increase in effective current raises the ohmic losses in the conductors, and the increase in effective voltage increases the losses in the dielectric.

The increased loss caused by an SWR greater than 1 may or may not be serious. If the SWR at the load is not greater than 2, the *additional* loss caused by the standing waves, as compared with the loss when the line is perfectly matched, does not amount to more than about 1/2 dB even on very long lines. Since 1/2 dB is an undetectable change in signal strength, it can be said that from a practical standpoint an SWR of 2 or less is, so far as losses are concerned, every bit as good as a perfect match.

The effect of SWR on line loss is shown in Fig. 3-23. The horizontal axis is the attenuation, in decibels, of the line when perfectly matched. The vertical axis gives the *additional* attenuation, in decibels, caused by standing waves. For example, if the loss in a certain line is 4 dB when perfectly matched, an SWR of 3 on that same line will cause an additional loss of 1.1 dB, approximately. The total loss on the poorly matched line is therefore  $4 + 1.1 = 5.1$  dB. If the SWR were 10 instead of 3, the additional loss would be 4.3 dB, and the total loss  $4 + 4.3 = 8.3$  dB.

It is important to note that the curves in Fig. 3-23 which represent SWR are the values which exist *at the load*. In most cases of amateur operation, this will be at the antenna end of a length of transmission line. The SWR as measured at the *input* or transmitter end of the line will be less, depending on the line attenuation. It is not always convenient to measure SWR directly at the antenna. However, by using the graph shown in Fig. 3-24, the SWR at the load can be obtained by

measuring it at the input to the transmission line and using the known (or estimated) loss of the transmission line. (See later section on testing coaxial cable.) For example, if the SWR at the transmitter end of a line is measured as 3 to 1 and the line is known to have a total attenuation (under matched conditions) of 1 dB, the SWR at the load end of the line will be 4.5 dB. From Fig. 3-23, the additional loss is nearly 1 dB because of the presence of the SWR. The total line loss in this case is 2 dB.

It is of interest to note that when the line loss is high with perfect matching, the *additional* loss in dB caused by the SWR tends to be constant regardless of the matched line loss. The reason for this is that the amount of power available to be reflected from the load is reduced, because relatively little power reaches the load in the first place. For example, if the line loss with perfect matching is 6 dB, only 25% of the power originally put into the line reaches the load. If the mismatch at the load (the SWR at the load) is 4 to 1, 36% of the power reaching the load will be reflected. Of the power originally put into the line, then,  $0.25 \times 0.36 = 0.09$  or 9% will be reflected. This in turn will be attenuated 6 dB in traveling back to the input end of the line, so that only  $0.09 \times 0.25 = 0.0225$  or slightly over 2% of the original power actually gets back to the input terminals. With such a small proportion of power returning to the input terminals the SWR measured at the *input* end of the line would be only about 1.35 to 1 – although it is 4 to 1 at the load. In the presence of line losses the SWR always decreases along the line going from the load to the input end.

On lines having low losses when perfectly matched, a high standing-wave ratio may increase the power loss by a large factor. However, in this case the *total* loss may still be inconsequential in comparison with the power delivered to the load. An SWR of 10 on a line having only 0.3 dB loss when perfectly matched will cause an additional loss of 1 dB, as shown by the curves. This loss would produce a just-detectable difference in signal strength.

**LINE-LOSS CONSIDERATIONS WITH THE SMITH CHART**

The problems presented earlier ignored attenuation, or line losses. Quite frequently it is not even necessary to consider losses when making calculations; any difference in readings obtained would be almost imperceptible on the Smith Chart. When the line losses become appreciable, as described above, loss considerations may be warranted in making Smith Chart calculations. This involves only one simple step, in addition to the procedures previously presented.

Because of line losses, the SWR does not remain constant throughout the length of the line, as just discussed. As a result, there is a decrease in SWR as one progresses away from the load. To truly represent this situation on the Smith Chart, instead of drawing a constant-SWR circle, it would be

necessary to draw a spiral inward and clockwise from the load impedance toward the generator. The rate at which the curve spirals toward prime center is related to the attenuation in the line. Rather than drawing spiral curves, a simpler method is used in solving line-loss problems, by means of the external scale TRANSMISSION-LOSS, 1-DB STEPS in Fig. 3-25. Because this is only a relative scale, the dB steps are not numbered.

If we start at the top end of this external scale and proceed in the direction indicated toward generator, the first dB step is seen to occur at a radius from center corresponding to an SWR of about 9 (at A); the second dB step falls at an SWR of about 4.5 (at B), the third at 3.0 (at C), and so forth, until the 15th dB step falls at an SWR of about 1.05 to 1. This means that a line terminated in a short or open circuit (infinite SWR) and having an attenuation of 15 dB, would exhibit an SWR of only 1.05 at its input. It will be noted that the dB steps near the lower end of the scale are very close together, and a line attenuation of 1 or 2 dB in this area will have only slight effect on the SWR. But near the upper end of the scale, 1- or 2-dB loss has considerable effect on the SWR.

In solving a problem utilizing line-loss information, it is necessary only to modify the radius of the SWR circle by an amount indicated on the TRANSMISSION-LOSS, 1-DB-STEPS scale. This is accomplished by drawing a second SWR circle, of

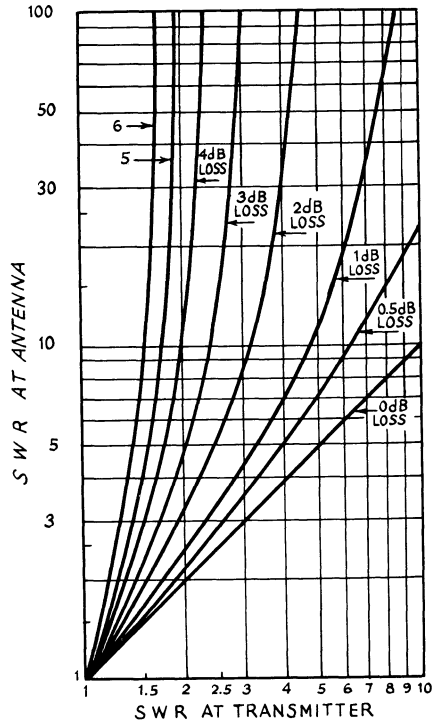

Fig. 3-24 – SWR at input end of transmission line vs. SWR at load end for various values of matched-line loss.

either greater or lesser radius than the first, as the case may be.

For example, assume that we have a 50-ohm line 0.282 wavelength long, with 1-dB inherent attenuation. The line input impedance is measured as  $60 + j35$  ohms. We desire to know the SWR at the input and at the load, and the load impedance. As before, we normalize the  $60 + j35$ -ohm impedance, plot it on the Chart, and draw a constant-SWR circle and a radial line through the point. In this case, the normalized impedance is  $1.2 + j0.7$ . From Fig. 3-25, the SWR at the line input is seen to be 1.9 (at D), and the radial line is seen to cross the TOWARD-LOAD scale at 0.328 (at E). To the 0.328 we add the line length, 0.282, and arrive at a value of 0.610. To locate this point on the TOWARD-LOAD scale, first subtract 0.500, and locate 0.110 (at F); then draw a radial line from this point to prime center.

To account for line losses, transfer the radius of the SWR circle to the external 1-DB-STEPS scale. This radius will cross the external scale at G, the fifth dB mark from the top. Since the line loss was given as 1 dB, we strike a new radius (at H), one "tick mark" higher (toward load) on the same scale. (This will be the fourth dB tick mark from the top of the scale.) Now transfer this new radius back to the main chart, and scribe a new SWR circle of this radius. This new radius represents the SWR at the load, and is read as about 2.3 on the external S.W.V.R. scale. At the intersection of the new circle and the load radial line, we read  $0.65 - j0.6$  as the normalized load impedance. Multiplying

by 50, the actual load impedance is  $32.5 - j30$  ohms. The SWR in this problem was seen to increase from 1.9 at the line input to 2.3 (at I) at the load, with the 1-dB line loss taken into consideration.

In the example above, values were chosen to fall conveniently on or very near the "tick marks" on the 1-DB scale. Actually, it is a simple matter to interpolate between these marks when making a radius correction. When this is necessary, the relative distance between marks for each dB step should be maintained while counting off the proper number of steps.

Adjacent to the 1-DB-STEPS scale lies a LOSS-COEFFICIENT scale. This scale provides a factor by which the matched-line loss in dB should be multiplied to account for the increased losses in the line when standing waves are present. These added losses do not affect the standing-wave ratio or impedance calculations; they are merely the additional dielectric and copper losses of the line caused by the fact that the line conducts more average current and must withstand more average voltage in the presence of standing waves. In the above example and in Fig. 3-25, the loss coefficient at the input end is seen to be 1.21 (at J), and 1.39 (at K) at the load. As a good approximation, the loss coefficient may be averaged over the length of line under consideration; in this case, the average is 1.3. This means that the total losses in the line are 1.3 times the matched loss of the line (1 dB), or 1.3 dB, the same result that may be obtained from Fig. 3-23 for the data of the above example.

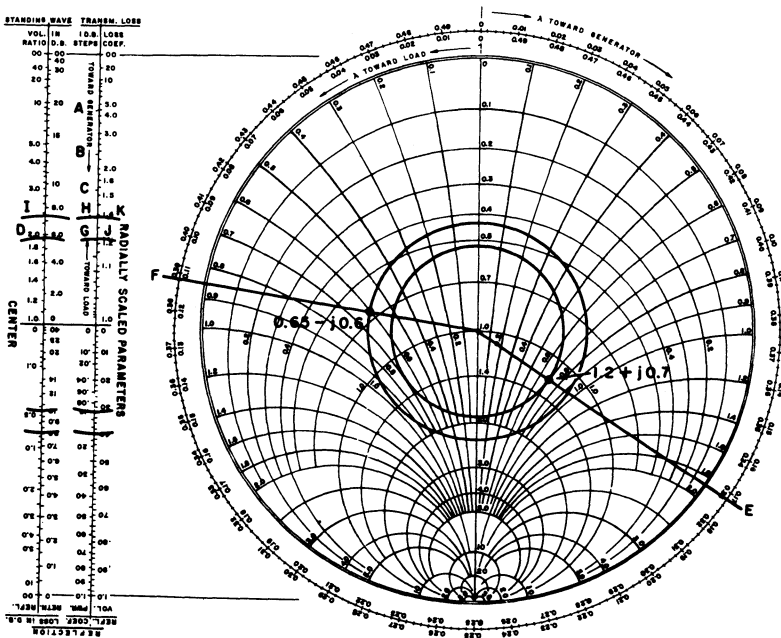

Fig. 3-25 — Example of Smith Chart calculations taking line losses into account.

**Smith Chart Procedure Summary**

To summarize briefly, any calculations made on the Smith Chart are performed in four basic steps, although not necessarily in the order listed.

- 1) Normalize and plot a line input (or load) impedance, and construct a constant-SWR circle.
- 2) Apply the line length to the wavelengths scales.
- 3) Determine attenuation or loss, if required, by means of a second SWR circle.
- 4) Read normalized load (or input) impedance, and convert to impedance in ohms.

The Smith Chart may be used for many types of problems other than those presented as examples here. The transformer action of a length of line – to transform a high impedance (with perhaps high reactance) to a purely resistive impedance of low value – was not mentioned. This is known as “tuning the line,” for which the Chart is very helpful, eliminating the need for cut-and-try procedures. The Chart may also be used to calculate lengths for shorted or open matching stubs in a system, described later in this chapter. In fact, in any application where a transmission line is not perfectly matched, the Smith Chart can be of value.

**VOLTAGES AND CURRENTS ON LINES**

The power reflected from a mismatched load does not represent an actual loss, except as it is attenuated in traveling back to the input end of the line. It merely represents power returned, and the actual effect is to reduce the power taken from the source. That is, it reduces the coupling between the power source and the line. This is easily overcome by readjusting the coupling until the actual power put into the line is the same as it would be with a matched load. In doing this, of course, the voltages and currents at loops along the line are increased.

As an example, suppose that a line having a characteristic impedance of 600 ohms is matched by a resistive load of 600 ohms and that 100 watts of power goes into the input terminals. The line simply looks like a 600-ohm resistance to the source of power. By Ohm’s Law the current and voltage in such a matched line are

$$I = \sqrt{P/R}$$

$$E = \sqrt{PR}$$

Substituting 100 watts for  $P$  and 600 ohms for  $R$ , the current is 0.408 ampere and the voltage is 245 volts. Assuming for the moment that the line has no losses, all the power will reach the load so the voltage and current at the load will be the same as at the input terminals.

Now suppose that the load is 60 ohms instead of 600 ohms. The SWR is 10, therefore. The reflection coefficient, or ratio of the reflected voltage or current to the voltage or current arriving at the load, is

$$\rho = \frac{SWR - 1}{SWR + 1}$$

In this case the reflection coefficient is  $(10 - 1)/(10 + 1) = 9/11 = 0.818$ , so that the reflected

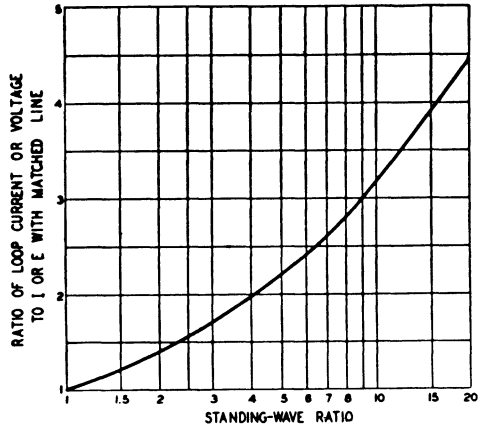

Fig. 3-26 – Increase in maximum value of current or voltage on a line with standing waves, as referred to the current or voltage on a perfectly matched line, for the same power delivered to the load. Voltage and current at minimum points are given by the reciprocals of the values along the vertical axis. The curve is plotted from the relationship, current (or voltage) ratio =  $\sqrt{SWR}$ .

voltage and current are both equal to 81.8% of the incident voltage and current. The reflected *power* is proportional to the square of either the current or voltage, and so is equal to  $(0.818)^2 = 0.67$  times the incident power, or 67 watts. Since we have assumed that the line has no losses, this amount of power arrives back at the input terminals and subtracts from the original 100 watts, leaving only 33 watts as the amount of power actually taken from the source.

In order to put 100 watts into the 60-ohm load the coupling to the source must be increased so that the incident power minus the reflected power equals 100 watts, and since the power absorbed by the load is only 33% of that reaching it, the incident power must equal  $100/0.33 = 303$  watts. In a perfectly matched line, the current and voltage with 303 watts input would be 0.71 ampere and 426 volts, respectively. The reflected current and voltage are 0.818 times these values, or 0.581 ampere and 348 volts. At current maxima or loops the current will therefore be  $0.71 + 0.58 = 1.29$  A, and at a minimum point will be  $0.71 - 0.58 = 0.13$  A. The voltage maxima and minima will be  $426 + 348 = 774$  volts and  $426 - 348 = 78$  volts. (Because of rounding off figures in the calculation process, the SWR does not work out to be exactly 10 in either the voltage or current case, but the error is very small.)

In the interests of simplicity this example has been based on a line with no losses, but the approximate effect of line attenuation could be included without much difficulty. If the matched-line loss were 3 dB, for instance, only half the input power would reach the load, so new values of current and voltage at the load would be computed accordingly. The reflected power would then be based on the attenuated figure, and then itself

attenuated 3 dB to find the power arriving back at the input terminals. The overall result would be, as stated before, a reduction in the SWR at the input terminals as compared with that at the load, along with less actual power delivered to the load for the same power input to the line.

Fig. 3-26 shows the ratio of current or voltage at a loop, in the presence of standing waves, to the current or voltage that would exist with the same power in a perfectly matched line. Strictly speaking, the curve applies only near the load in the case of lines with appreciable losses. However, the curve shows the maximum possible value of current or voltage that can exist along the line whether there are line losses or not, and so is useful in determining whether or not a particular line can operate safely with a given SWR.

**SPECIAL CASES**

Besides the primary purpose of transporting power from one point to another, transmission lines have properties that are useful in a variety of ways. One such special case is a line an exact multiple of one-quarter wavelength (90 degrees) long. As shown earlier, such a line will have a purely resistive input impedance when the termination is a pure resistance. Also, unterminated – i.e., short-circuited or open-circuited – lines can be used in place of conventional inductors and capacitors since such lines have an input impedance that is substantially a pure reactance when the line losses are low.

**The Half-Wavelength Line**

When the line length is an even multiple of 90 degrees (that is, a multiple of a half wavelength), the input resistance is equal to the load resistance. As a matter of fact, a line an *exact* multiple of a half wave in length (disregarding line losses)

simply repeats, at its input or sending end, whatever impedance exists at its output or receiving end; it does not matter whether the impedance at the receiving end is resistive, reactive, or a combination of both. Sections of line having such length can be cut in or out without changing any of the operating conditions, at least when the losses in the line itself are negligible.

**Impedance Transformation with Quarter-Wave Lines**

The input impedance of a line an odd multiple of a quarter wavelength long is

$$Z_s = \frac{Z_o^2}{Z_R}$$

where  $Z_s$  is the input impedance and  $Z_R$  is the load impedance. If  $Z_R$  is a pure resistance,  $Z_s$  also will be a pure resistance. Rearranging this equation gives

$$Z_o = \sqrt{Z_s Z_R}$$

This means that if we have two values of impedance that we wish to “match,” we can do so if we connect them together by a quarter-wave transmission line having a characteristic impedance equal to the square root of their product.

A quarter-wave line is, in effect, a transformer. It is frequently used as such in antenna work when it is desired, for example, to transform the impedance of an antenna to a new value that will match a given transmission line. This subject is considered in greater detail in a later section of this chapter.

**Lines as Circuit Elements**

An open- or short-circuited line does not deliver any power to a load, and for that reason is not, strictly speaking, a “transmission” line. However, the fact that a line of the proper length has inductive reactance makes it possible to substitute

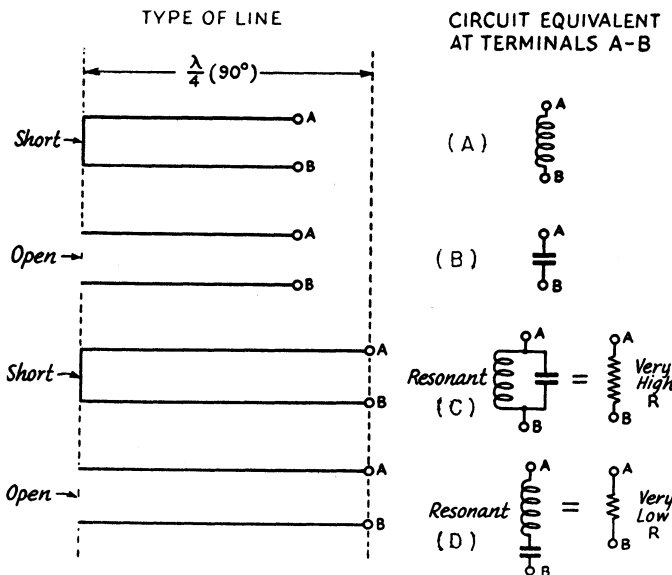

Fig. 3-27 — Lumped-constant circuit equivalents of open- and short-circuited transmission lines.

the line for a coil in an ordinary circuit. Likewise another line of appropriate length having capacitive reactance can be substituted for a capacitor.

Sections of lines used as circuit elements are usually a quarter wavelength or less long. The desired type of reactance (inductive or capacitive) or the desired type of resonance (series or parallel) is obtained by shorting or opening the far end of the line. The circuit equivalents of various types of line sections are shown in Fig. 3-27.

When a line section is used as a reactance, the amount of reactance is determined by the characteristic impedance and the electrical length of the line. The type of reactance exhibited at the input terminals of a line of given length depends on whether it is open- or short-circuited at the far end.

The equivalent "lumped" value for any "inductor" or "capacitor" may be determined with the aid of the Smith Chart. Line losses may be taken into account if desired, as explained in an earlier section. See Fig. 3-28. Remember that the right half of the Smith Chart coordinate system is used for impedances containing inductive reactances, and the left half for capacitive reactances. For example, a section of 600-ohm line  $3/16$ -wavelength long ( $0.1875 \lambda$ ) and short-circuited at the far end is represented by L1, drawn around a portion of the perimeter of the Chart. The "load" is a short-circuit,  $0 + j0$  ohms, and the TOWARD GENERATOR wavelengths scale is used for marking off the line length. At A in Fig. 3-28 may be read the normalized impedance as seen looking into the length of line,  $0 + j2.4$ . The reactance is therefore inductive, equal to  $600 \times 2.4 = 1440$  ohms. The same line open-circuited (termination impedance =  $\infty$ , the point at the bottom of the Chart) is represented by L2 in Fig. 3-28. At B the normalized line-input impedance may be read as  $0 - j0.41$ ; the reactance in this case is capacitive,  $600 \times 0.41 = 246$  ohms. (Line losses are disregarded in these examples.) From Fig. 3-28 it is easy to visualize that if L1 were to be extended by a quarter wavelength, represented by L3, the line-input impedance would be identical to that obtained in the case represented by L2 alone. In the case of L2, the line is open-circuited at the far end, but in the case of L3 the line is terminated in a short. The added quarter wavelength of line for L3 provides the "transformer action" discussed in the previous section.

The equivalent inductance and capacitance as determined above can be found by substituting these values in the formulas relating inductance and capacitance to reactance, or by using the various charts and calculators available. The frequency corresponding to the line length in degrees must be used, of course. In this example, if the frequency is 14 MHz the equivalent inductance and capacitance in the two cases are  $16.4 \mu\text{H}$  and  $46.2 \text{ pF}$ , respectively. Note that when the line length is 45 degrees ( $0.125$  wavelength) the reactance in

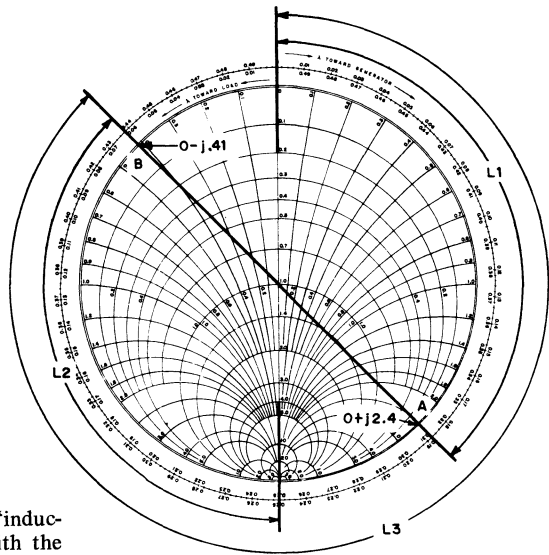

Fig. 3-28 — Smith Chart determination of input impedances for short- and open-circuited line sections, disregarding line losses.

either case is numerically equal to the characteristic impedance of the line. In using the Smith Chart it should be kept in mind that the electrical length of a line section depends on the frequency and velocity of propagation as well as on the actual physical length.

In the case of a line having no losses, and to a close approximation when the losses are small, the inductive reactance of a short-circuited line less than a quarter wave in length is

$$X_L \text{ (ohms)} = Z_0 \tan l$$

where  $l$  is the length of the line in electrical degrees and  $Z_0$  is the characteristic impedance of the line. The capacitive reactance of an open-circuited line less than a quarter wave in length is

$$X_C \text{ (ohms)} = Z_0 \cot l$$

At lengths of line that are exact multiples of a quarter wavelength, such lines have the properties of resonant circuits. At lengths where the input reactance passes through zero at the top of the Smith Chart, the line acts like a series-resonant circuit, as shown at D of Fig. 3-27. At lengths for which the reactances theoretically pass from "positive" to "negative" infinity at the bottom of the Smith Chart, the line simulates a parallel-resonant circuit, as at C of Fig. 3-27. The effective  $Q$  of such linear resonant circuits is very high if the line losses, both in resistance and by radiation, are kept down. This can be done without much difficulty, particularly in coaxial lines, if air insulation is used between the conductors. Air-insulated open-wire lines are likewise very good at frequencies for which the conductor spacing is very small in terms of wavelength.

Applications of line sections as circuit elements in connection with antenna and transmission-line systems are discussed later in this chapter.

## LINE CONSTRUCTION AND OPERATING CHARACTERISTICS

The two basic types of transmission lines, parallel-conductor and coaxial, can be constructed in a variety of forms. Both types can be divided into two classes: those in which the majority of the insulation between the conductors is air, only the minimum of solid dielectric necessary for mechanical support being used; and those in which the conductors are imbedded in and separated by a solid dielectric. The former class (air-insulated) has the lowest loss per unit length because there is no power loss in dry air so long as the voltage between conductors is below the value at which corona forms. At the maximum power permitted in amateur transmitters it is seldom necessary to consider corona unless the SWR on the line is very high.

### AIR-INSULATED LINES

A typical type of construction used for parallel-conductor or "two-wire" air-insulated transmission lines is shown in Fig. 3-29. The two line wires are supported a fixed distance apart by means of insulating rods called spacers. Spacers may be made from insulating material, such as phenolic, or can be purchased ready-made. Materials commonly used in manufactured spacers are isolantite, Lucite, and polystyrene. The spacers used vary from two to six inches, the smaller spacings being desirable at the higher frequencies (28 MHz) so that radiation will be minimized. It is necessary to use the spacers at small enough intervals along the line to prevent the two wires from swinging appreciably with respect to each other in a wind. For amateur purposes, lines using this construction ordinarily have No. 12 or No. 14 conductors, and the characteristic impedance is from 500 to 600 ohms.

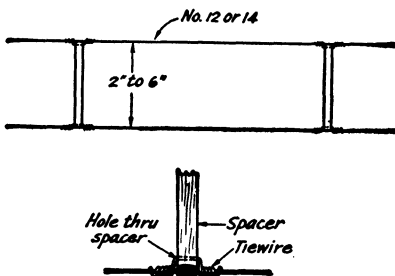

Fig. 3-29 — Typical open-wire line construction. Commercial spacers are usually provided with grooved ends for the line conductors. The conductor is held in place by a tie wire anchored in a hole near the groove.

Although once in universal use, such lines have now been largely superseded by prefabricated lines.

Prefabricated open-wire lines (sold principally for television receiving applications) are available in nominal characteristic impedances of 450 and 300 ohms. The spacers, of low-loss material such as polystyrene, are molded on the conductors at relatively small intervals so there is no tendency for

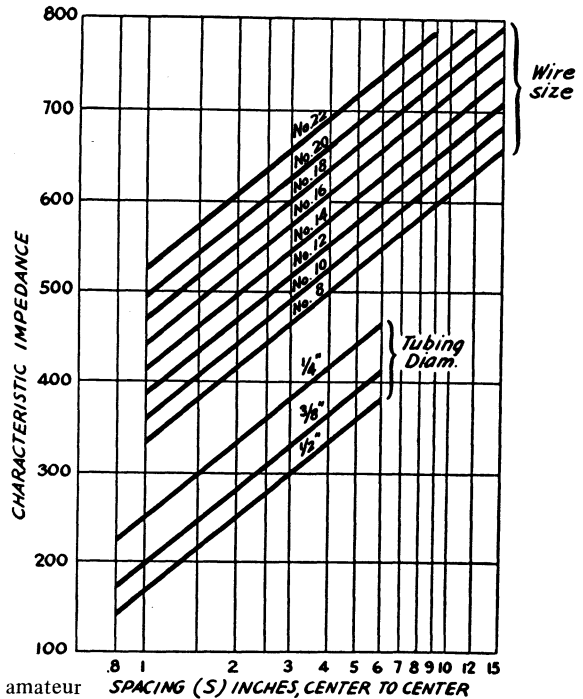

Fig. 3-30 — Characteristic impedance vs. conductor size and spacing for parallel-conductor lines.

the conductors to swing with respect to each other. A conductor spacing of one inch is used in the "450-ohm" line and 1/2 inch in the "300-ohm" line. The conductor size is usually about No. 18. The impedances of such lines are somewhat lower than given by Fig. 3-30 for the same conductor size and spacing, because of the effect of the dielectric constant of the numerous spacers used. The attenuation is quite low and lines of this type are entirely satisfactory for transmitting applications at amateur powers.

When an air-insulated line having still lower characteristic impedance is needed, metal tubing having a diameter from 1/4 to 1/2 inch is frequently used. With the larger conductor diameter and relatively close spacing it is possible to build a line having a characteristic impedance as low as about



200 ohms. This type of construction is used principally for quarter-wave matching transformers at the higher frequencies.

**Characteristic Impedance**

The characteristic impedance of an air-insulated parallel-conductor line, neglecting the effect of the insulating spacers, is given by:

$$Z_o = 276 \log \frac{b}{a}$$

- where  $Z_o$  = Characteristic impedance
- $b$  = Center-to-center distance between conductors
- $a$  = Radius of conductor (in same units as  $b$ )

It does not matter what units are used for  $a$  and  $b$  so long as they are the *same* units. Both quantities may be measured in centimeters, inches, etc. Since it is necessary to have a table of common logarithms to solve practical problems, the solution is given in graphical form in Fig. 3-30 for a number of common conductor sizes.

**Four-Wire Lines**

Another type of parallel-conductor line that is useful in some special applications is the four-wire line. In cross-section, the conductors of the four-wire line are at the corners of a square, the spacings being of the same order as those used in two-wire lines. The conductors at opposite corners of the square are connected together to operate in parallel. This type of line has a lower characteristic impedance than the simple two-wire type. Also, because of the more symmetrical construction it is better balanced, electrically, to ground and other objects that may be close to the line. The spacers for a four-wire line may be disks of insulating material, X-shaped members, etc.

**Coaxial Lines**

In coaxial lines of the air-insulated type a considerable proportion of the insulation between conductors may actually be a solid dielectric, because of the necessity for maintaining constant separation between the inner and outer conductors. This is particularly likely to be true in small-diameter lines, typical construction of which is shown in Fig. 3-31. The inner conductor, usually a solid copper wire, is supported by insulating beads at the center of the copper-tubing outer conductor. The beads usually are insulantite and the wire is generally crimped on each side of each bead to prevent the beads from sliding. The material of which the beads are made, and the number of them per unit length of line, will affect the characteristic impedance of the line. The greater the number of beads in a given length, the lower the characteristic impedance compared with the value that would be obtained with air insulation only. The presence of the solid dielectric also increases the losses in the line. On the whole, however, a coaxial line of this type tends to have lower actual loss, at frequencies up to about 100 MHz, than any other line

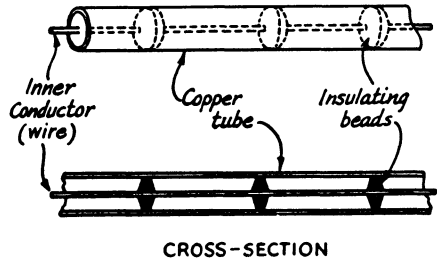

Fig. 3-31 — Construction of air-insulated coaxial lines.

construction, provided the air inside the line can be kept dry. This usually means that air-tight seals must be used at the ends of the line and at every joint.

The characteristic impedance of an air-insulated coaxial line is given by the formula

$$Z_o = 138 \log \frac{b}{a}$$

- where  $Z_o$  = Characteristic impedance
- $b$  = Inside diameter of outer conductors
- $a$  = Outside diameter of inner conductor (in same units as  $b$ )

Again it does not matter what units are used for  $b$  and  $a$ , so long as they are the same. Curves for typical conductor sizes are given in Fig. 3-32.

The formula and curves for coaxial lines are approximately correct for lines in which bead spacers are used, provided the beads are not too closely spaced.

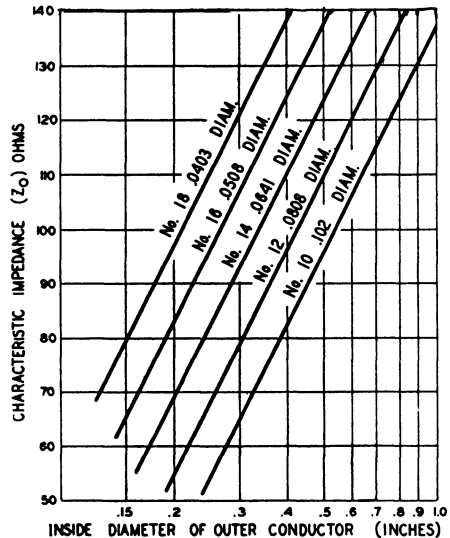

Fig. 3-32 — Characteristic impedance of typical air-insulated coaxial lines.

## FLEXIBLE LINES

Transmission lines in which the conductors are separated by a flexible dielectric have a number of advantages over the air-insulated type. They are less bulky, weigh less in comparable types, maintain more uniform spacing between conductors, are generally easier to install, and are neater in appearance. Both parallel-conductor and coaxial lines are available with this type of insulation.

The chief disadvantage of such lines is that the power loss per unit length is greater than in air-insulated lines. The power loss causes heating of the dielectric, and if the heating is great enough — as it may be with high power and a high standing-wave ratio — the line may break down both mechanically and electrically.

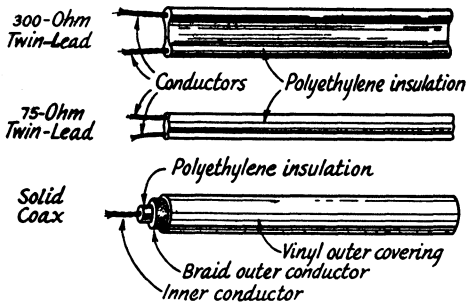

Fig. 3-33 — Construction of parallel-conductor and coaxial lines with solid dielectric.

### Parallel-Conductor Lines

The construction of a number of types of flexible lines is shown in Fig. 3-33. In the most common 300-ohm type ("Twin-Lead" is one trade name) the conductors are stranded wire equivalent to No. 20 in cross-sectional area and are molded in the edges of a polyethylene ribbon about a half inch wide. The effective dielectric is partly solid and partly air. The presence of the solid dielectric lowers the characteristic impedance of the line as compared with the same conductors in air, the result being that the impedance is approximately 300 ohms. The fact that part of the field between the conductors exists outside the solid dielectric leads to an operating disadvantage in that dirt or moisture on the surface of the ribbon tends to change the characteristic impedance. The operation of the line is therefore affected by weather conditions. The effect will not be very serious in a line terminated in its characteristic impedance, but if there is a considerable standing-wave ratio a small change in  $Z_0$  may cause wide fluctuations of the input impedance. Weather effects can be minimized by cleaning the line occasionally and giving it a thin coating of a water-repellent material such as silicone grease or automobile wax.

To overcome the effects of weather on the characteristic impedance and attenuation of ribbon-type line, another type of Twin-Lead is made using a polyethylene tube with the conduc-

tors molded diametrically opposite each other in the walls. This increases the leakage path across the dielectric surface. Also, much of the electric field between the conductors is in the hollow center of the tube, which can be protected from dirt and weather by closing the exposed end of the tube to make it watertight. This type of line is fairly impervious to weather effects. Care should be used when installing it, however, to make sure that any moisture that condenses on the inside with changes in temperature and humidity can drain out the bottom end of the tube and not be trapped in one section. This type of line is made in two conductor sizes (with different tube diameters), one for receiving applications and the other for transmitting.

The transmitting-type 75-ohm Twin-Lead uses stranded conductors about equivalent to solid No. 12 wire, with quite close spacing between conductors. Because of the close spacing most of the field is confined to the solid dielectric, very little existing in the surrounding air. This makes the 75-ohm line much less susceptible to weather effects than the 300-ohm ribbon type.

In addition to the parallel-conductor types described above, there are also lightweight two-wire lines of 150 and 75 ohms. These are useful for receiving antennas, but are not heavy enough to carry very much power.

### Coaxial Lines

Flexible "coax" is available in a rather large number of different types. However, the basic construction is the same in all, and is typified in the drawing in Fig. 3-33. The overall diameter varies from a little less than 1/4 inch to somewhat over an inch, depending chiefly on the power requirements for which the cable was designed. In some cables the inner conductor is stranded; in others, solid wire is used. In some the outer conductor is a single braid; in others it is double. The outer jacket, usually vinyl plastic, plays no part in the electrical performance of the cable, but is simply a waterproof covering.

The dielectric material used in these cables is polyethylene, a flexible plastic having low losses at radio frequencies. In many types of cable (particularly the RG series) the dielectric is solid polyethylene. The losses in the solid dielectric are relatively low, if the operating frequency is not too high. A few types of cable (RG-62/U is an example) use a polyethylene thread wound around the inner conductor; this makes the insulation partly air, effecting a reduction in both loss and capacitance per unit length. A popular type of dielectric in the more recently developed cables is "foamed" polyethylene, which has a cellular structure similar to a honeycomb so that a large part of the dielectric is air. The loss per unit length in such cables is appreciably less than in those using solid dielectric. The foam-polyethylene dielectric is susceptible to moisture penetration, which will cause an increase in the attenuation.

Solid coaxial cables are available in two principal characteristic impedances, approximately 50 and 75 ohms.

TABLE 3-1 — TRANSMISSION LINES

Type of Line	Nominal Imp., ohms	RG/U Type	Mfrs. No.	Outside Dia inches	Jacket	Inner Cond. Size	Dielectric	Cap. per ft. pF	Velocity Factor	Max. rms Voltage	Power Rating, Watts Up to		Connector Series	
											30 MHz	400 MHz		
Flexible Coaxial Medium	52	8		.405	I	7/21	SP	29.5	.66	5000	1720	465	UHF, N	
	52	8A	621-111	.405	IIA	7/21	FP	29.5	.66	5000	1720	465	UHF, N	
	50		T-4-50	.407	X	10	FP	24.5	.80	1500			UHF	
	50	11		.405	I	7/26	SP	20.5	.66	5000	1400	340	UHF, N	
	75	11A		.405	IIA	7/26	SP	20.5	.66	5000	1400	340	UHF, N	
	75		621-100	.405	I	14	FP	16.5	.80	3000			UHF	
	75		JT-204	.407	X	14	FP						UHF	
	Small	53.5	58		.195	I	20	SP	28.5	.66	1900	580	135	UHF, BNC, N
		50	58A		.195	I	19/.0071	SP	30	.66	1900	550	105	UHF, BNC, N
		53.5	58B		.195	IIIA	20	SP	28.5	.66	1900	580	135	UHF, BNC, N
50		58C		.195	IIA	19/.0071	SP	30	.66	1900	550	105	UHF, BNC, N	
73		59		.242	I	22 cw	SP	21.5	.66	2300	720	185	UHF, BNC, N	
75		59B		.242	IIA	.023 cw	SP	21	.66	2300	720	185	UHF, BNC, N	
73			621-186	.242	P	20 cw	FP	17.3	.80	1000			UHF, BNC	
93		62		.242	I	22 cw	SSP	13.5	.84	750	850	230	UHF, BNC, N	
Parallel Conductor Flat or Oval		75		214-023			7/21	SP	20	.71		1000		
		300		214-056			7/28	SP	5.8	.82				
Tubular	300		214-022			16 cw	SP	3.0	.82					
	300		214-271			7/28	PA		.82		500			
	300		214-076			7/26	PA		.82		1000			
			214-103			7/28	FP*	3.9						

Column 3: T-4-50 and JT-204 are manufactured by Times Wire & Cable, Wallingford, Conn. Other numbers are types made by Amphenol, Chicago, Ill.

Column 5: I — Polyvinyl chloride (PVC), black. IIA — Noncontaminating PVC, black or gray. IIIA — Polyethylene, black. Noncontaminating and abrasion-resistant. Recommended when cable is to be buried underground. P — Polyethylene. X — Xelon.

Column 6: Conductors are copper unless followed by CW (copper-weld). Decimal numbers give wire diameter in inches; others are standard copper-wire gauge except when preceding a virgule, when the figure indicates number of strands: e.g., 7/21 means 7 strands of No. 21 copper wire.

Column 7: SP — Solid polyethylene. SSP — Polyethylene strand wound around inner conductor; enclosed in solid tube of same material. FP — Foamed polyethylene. FP\* — Foamed polyethylene surrounding each conductor; outer en-

closure solid polyethylene. Type 214-103 is intended for use under adverse moisture and salt-spray conditions. PA — Polyethylene tube with air core.

Column 9: Open parallel-conductor line has a velocity factor of 0.95 to 0.975, depending on number of spacers and dielectric material of which they are made. Polyethylene spacers used in types listed.

Column 12: Only connectors in common use by amateurs are included.

If the entire field between the two conductors of a line is in a solid dielectric, as in the case of solid coaxial lines, the characteristic impedance of the line is reduced by the factor  $1/\sqrt{k}$  as compared with the impedance of an air-insulated line having the same conductor size and spacing. The quantity  $k$  is the effective dielectric constant of the insulating material. In ribbon or tubular type parallel-conductor lines and in the special coaxial types mentioned above, the field is partly in air and partly in the dielectric, so the reduction factor above cannot be applied directly.

The attenuation and other characteristics of the various types of lines commonly used by amateurs are shown in Table 3-1 and Fig. 3-34.

A whole series of fittings for making detachable connections to flexible coaxial cable is available. These include general-purpose connectors, some of which are quite inexpensive, and "constant-impedance" units especially designed so that lengths of cable can be spliced together or terminated without causing a change in the characteristic impedance. Such impedance "bumps" along a line correspond in a general way to having a load that is not matched to the line; that is, they will cause some of the outgoing power to be reflected back toward the input end. In most amateur applications it is not necessary to worry about such impedance discontinuities when using ordinary connectors because their effect at frequencies below 300 or 400 MHz is too small to be of practical consequence.

## SINGLE-WIRE LINE

There is one type of line, in addition to those already described, that deserves some mention since it is still used to a limited extent. This is the **single-wire line**, consisting simply of a single conductor running from the transmitter to the antenna. The "return" circuit for such a line is the earth; in fact, the second conductor of the line can be considered to be the image of the actual conductor in the same way that an antenna strung above the earth has an image (see Chapter Two). The characteristic impedance of the single-wire line depends on the conductor size and the height of the wire above ground, ranging from 500 to 600 ohms for No. 12 or No. 14 conductors at heights of 10 to 30 feet. By connecting the line to the antenna at a point that represents a resistive impedance of 500 to 600 ohms the line can be matched and will operate without standing waves.

Although the single-wire line is very simple to install, it has at least two outstanding disadvantages. Since the return circuit is through the earth, the behavior of the system depends on the kind of ground over which the antenna and transmission line are erected. In practice, it may not be possible to get the necessary good connection to actual ground that is required at the transmitter. Second, the line always radiates since there is no nearby second conductor to cancel the fields. The radiation will be minimum when the line is properly terminated because the line current is lowest under those conditions. However, the line is always a part

of the radiating antenna system to a greater or lesser extent.

## ELECTRICAL LENGTH

Whenever reference is made to a line as being so many wavelengths (such as a "half wavelength" or "quarter wavelength") long, it is to be understood that the *electrical* length of the line is meant. The physical length corresponding to an electrical wavelength is given by

$$\text{Length (feet)} = \frac{984}{f} V$$

where  $f$  = Frequency in megahertz  
 $V$  = Velocity factor

The **velocity factor** is the ratio of the actual velocity along the line to the velocity in free space. Values of  $V$  for several common types of lines are given in Table 3-1.

Because a quarter-wavelength line is frequently used as an impedance transformer, it is convenient to calculate the length of a quarter-wave line directly. The formula is

$$\text{Length (feet)} = \frac{246}{f} V$$

## LINE INSTALLATION

One great advantage of coaxial line, particularly the flexible dielectric type, is that it can be installed with almost no regard for its surroundings. It requires no insulation, can be run on or in the ground or in piping, can be bent around corners with a reasonable radius, and can be "snaked" through places such as the space between walls where it would be impracticable to use other types of lines. However, coax lines always should be operated in systems that permit a low standing-wave ratio, and precautions must be taken to prevent rf currents from flowing on the *outside* of the line. This point is discussed later in this chapter.

### Coaxial Fittings

There is a wide variety of fittings and connectors designed to go with various sizes and types of solid-dielectric coaxial line. The "UHF" series of fittings is by far the most widely used type in the amateur field, largely because they have been available for a long time and have been quite inexpensive on the surplus market. These fittings, typified by the PL-259 plug and SO-239 chassis fitting (Armed Services numbers) are quite adequate for vhf and lower frequency applications, but are not weatherproof.

The "N" series fittings are designed to maintain constant impedance at cable joints. They are a bit harder to assemble than the "UHF" type, but are better for frequencies above 300 MHz or so. These fittings are weatherproof.

The "BNC" fittings are for small cable such as RG-58/U, RG-59/U and RG-62/U. They feature a bayonet-locking arrangement for quick connect and disconnect, and are weatherproof.

Methods of assembling the connectors to the cable are shown on accompanying pages.

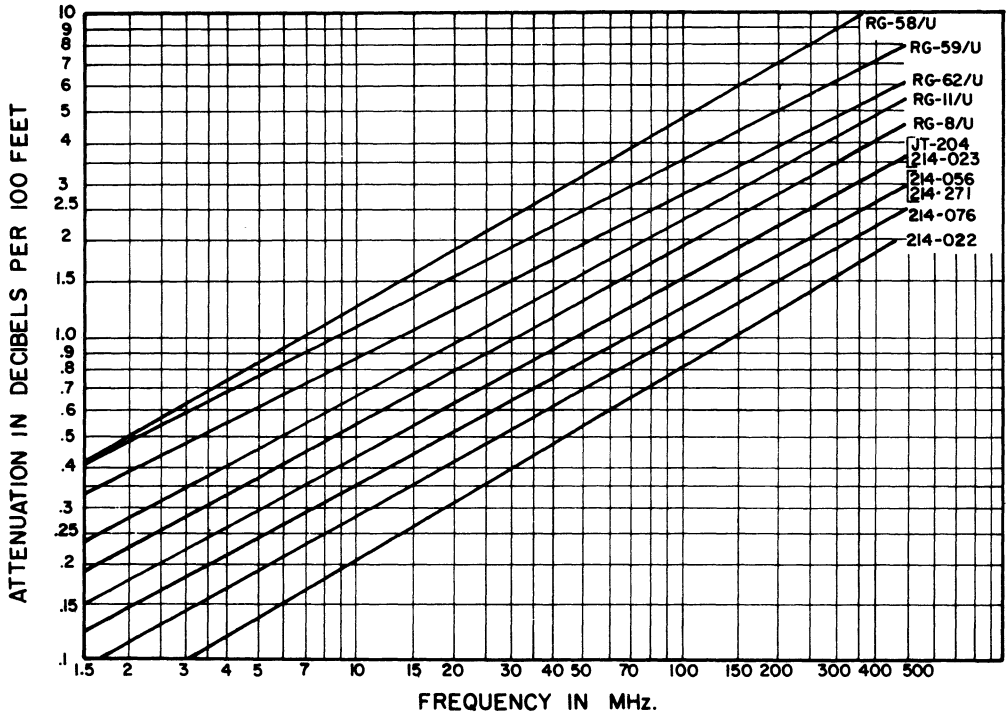

Fig. 3-34 — Nominal attenuation in decibels per 100 feet of various types of transmission line. Total attenuation is directly proportional to length. Attenuation will vary somewhat in actual cable samples, and generally increases with age in coaxial cables having a type I jacket. Cables grouped together in the above chart have approximately the same attenuation. Types having foam polyethylene dielectric have slightly lower loss than equivalent solid dielectric types, when not specifically shown above. The curve for RG-58/U also applies to RG-58B/U. For RG-58A/U and RG-58C/U add 10 percent to the loss in decibels given by the curve. RG-8A/U has the same loss as RG-8/U; RG-59B/U has the same loss as RG-59.

### Parallel-Wire Lines

In installing a parallel-wire line, care must be used to prevent it from being affected by moisture, snow and ice. In home construction, only spacers that are impervious to moisture and are unaffected by sunlight and the weather should be used on air-insulated lines. Steatite spacers meet this requirement adequately, although they are somewhat heavy. The wider the line spacing the longer the leakage path across the spacers, but this cannot be carried too far without running into line radiation, particularly at the higher frequencies. Where an open-wire line must be anchored to a building or other structure, standoff insulators of a height comparable with the line spacing should be used if mounted in a spot that is open to the weather. Lead-in bushings for bringing the line into a building also should have a long leakage path.

The line should be kept away from other conductors, including downspouting, metal window frames, flashing, etc., by a distance equal to two or three times the line spacing. Conductors that are very close to the line will be coupled to it in greater or lesser degree, and the effect is that of placing an additional load across the line at the

point where the coupling occurs. Reflections take place from this coupled "load," raising the standing-wave ratio. The effect is at its worst when one line wire is closer than the other to the external conductor. In such a case one wire carries a heavier load than the other, with the result that the line currents are no longer equal. The line then becomes "unbalanced."

Solid-dielectric two-wire lines have a relatively small external field because of the small spacing and can be mounted within a few inches of other conductors without much danger of coupling between the line and such conductors. Standoff insulators are available for supporting lines of this type when run along walls or similar structures.

Sharp bends should be avoided in any type of transmission line, because such bends cause a change in the characteristic impedance. The result is that reflections take place from each bend. This is of less importance when the SWR is high than when an attempt is being made to match the load to the line's characteristic impedance. It may be impossible to get the SWR down to a desired figure until the necessary bends in the line are made more gradual.

### BNC (UG-88/U) CONNECTORS

Connectors bearing suffix letters (UG-88C/U, etc.) differ slightly in internal construction; assembly and dimensions must be varied accordingly.

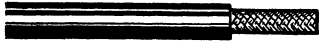

1) Cut end square and trim jacket 5/16" for RG-58/U.



2) Fray shield and strip inner dielectric 1/8". Tin center conductor.

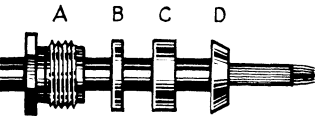

3) Taper braid and slide nut (A), washer (B), gasket (C), and clamp (D), over braid. Clamp is inserted so that its inner shoulder fits squarely against end of cable jacket.

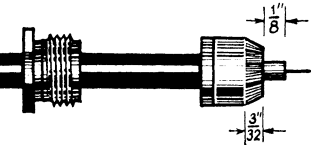

4) With clamp in place, comb out braid, fold back smooth as shown, and trim 3/32" from end.

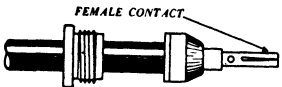

5) Tin center conductor of cable. Slip female contact in place and solder. Remove excess solder. Be sure cable dielectric is not heated excessively and swollen so as to prevent dielectric entering body.

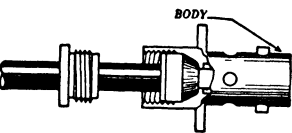

6) Push into body as far as it will go. Slide nut into body and screw into place with wrench until tight. Hold cable and shell rigidly and rotate nut.

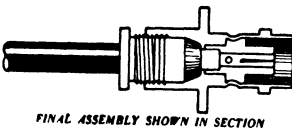

FINAL ASSEMBLY SHOWN IN SECTION

7) This assembly procedure applies to BNC jacks. The assembly for plugs is the same except for the use of male contacts and a plug body.

### 83-1SP (PL-259) PLUG

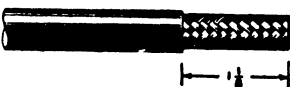

1) Cut end of cable even. Remove vinyl jacket 1-1/8" — don't nick braid.

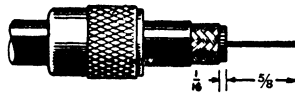

2) Bare 5/8" of center conductor — don't nick conductor. Trim braided shield 9/16" and tin. Slide coupling ring on cable.

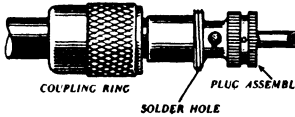

3) Screw the plug assembly on cable. Solder plug assembly to braid through solder holes. Solder conductor to contact sleeve. Screw coupling ring on assembly.

### N (UG-21/U) CONNECTORS

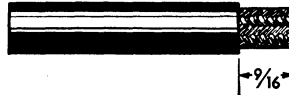

1) Remove 9/16" of vinyl jacket. When using double-shielded cable remove 5/8".

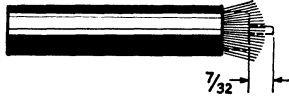

2) Comb out copper braid as shown. Cut off dielectric 7/32" from end. Tin center conductor.



3) Taper braid as shown. Slide nut, washer and gasket over vinyl jacket. Slide clamp over

braid with internal shoulder of clamp flush against end of vinyl jacket. When assembling connectors with gland, be sure knife-edge is toward end of cable and groove in gasket is toward the gland.



4) Smooth braid back over clamp and trim. Soft-solder contact to center conductor.

Avoid use of excessive heat and solder. See that end of dielectric is clean. Contact must be flush against dielectric. Outside of contact must be free of solder. Female contact is shown; procedure is similar for male contact.

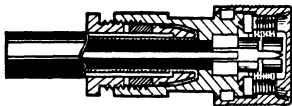

5) Slide body into place carefully so that contact enters hole in insulator (male contact

shown). Face of dielectric must be flush against insulator. Slide completed assembly into body by pushing nut. When nut is in place, tighten with wrenches. In connectors with gland, knife edge should cut gasket in half by tightening sufficiently.

**83 SERIES (SO-239) WITH HOODS**

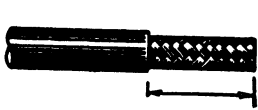

1) Cut end of cable even. Remove vinyl jacket to dimension appropriate for type of hood. Tin exposed braid.



2) Remove braid and dielectric to expose center conductor. Do not nick conductor.



3) Remove braid to expose dielectric to appropriate dimension. Tin center conductor. Soldering and assembly depends on the hood used, as illustrated.

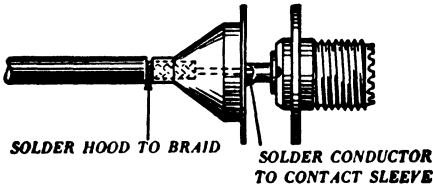

4) Slide hood over braid. Solder conductor to contact. Slide hood flush against receptacle and bolt both to chassis. Solder hood to braid as illustrated. Tape this junction if necessary. (For UG-177/U.)

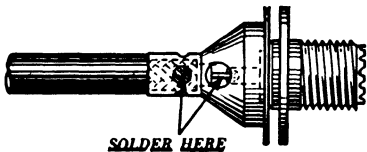

5) Slide hood over braid. Bring receptacle flush against hood. Solder hood to braid and conductor to contact sleeve through solder holes as illustrated. Tape junction if necessary. (For UG-372/U.)

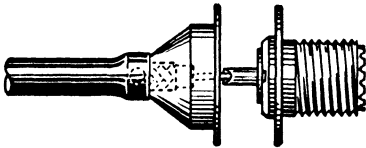

6) Slide hood over braid and force under vinyl. Place inner conductor in contact sleeve and solder. Push hood flush against receptacle. Solder hood to braid through solder holes. Tape junction if necessary. (For UG-106/U.)

**83-1SP (PL-259) PLUG WITH ADAPTERS (UG-176/U OR UG-175/U)**

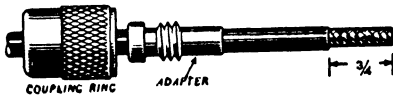

1) Cut end of cable even. Remove vinyl jacket 3/4" — don't nick braid. Slide coupling ring and adapter on cable.



2) Fan braid slightly and fold back over cable.



3) Position adapter to dimension shown. Press braid down over body of adapter and trim to 3/8". Bare 5/8" of conductor. Tin exposed center conductor.

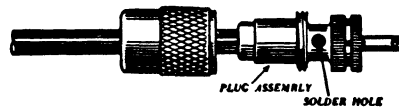

4) Screw the plug assembly on adapter. Solder braid to shell through solder holes. Solder conductor to contact sleeve.



5) Screw coupling ring on plug assembly.

### TESTING COAXIAL CABLE

Unknown coaxial cable or cable that has been exposed to the weather may have losses above the published figures for the cable type. A simple method for checking the losses in a cable is to use an rf ammeter (mounted in a metal box with coax fittings). Connect one end of the cable to a nonreactive dummy load of the *same impedance* as the coax. At the other end of the line insert the rf ammeter and connect it to a transmitter. Tune up the transmitter and make a note of the exact amount of current. Without touching the transmitter tuning, move the ammeter to the other end of the line, at the dummy load, and note the meter reading. Using Fig. 3-35, compare the readings to determine the decibel loss that is present in the line. Keep in mind that the cable must be terminated in its characteristic impedance (SWR of 1); otherwise, the data from Fig. 3-35 will not be accurate.

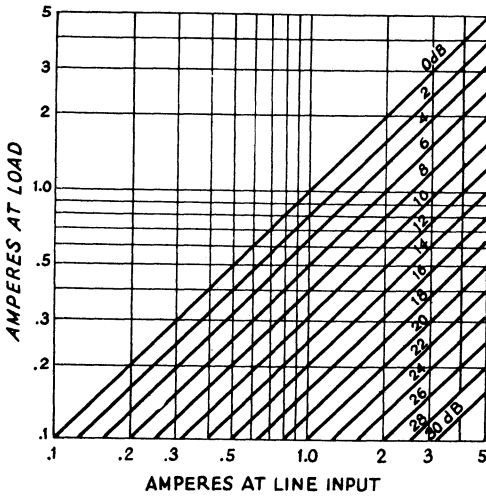

Fig. 3-35 — Graph for determining losses in transmission lines with an SWR of 1.

### COUPLING THE TRANSMITTER TO THE LINE

In any system using a transmission line to feed the antenna the load that the transmitter “sees” is the input impedance of the line. As shown earlier, this impedance is completely determined by the line length, the  $Z_0$  of the line, and the impedance of the load (the antenna) at the output end of the line. The line length and  $Z_0$  are generally matters of choice regardless of the type of antenna used. The antenna impedance, which may or may not be known accurately, is (with  $Z_0$ ) the factor that determines the standing-wave ratio.

The SWR can be measured with relative ease, and from it the limits of variation in the line input impedance can be determined with little difficulty. It may be said, therefore, that the problem of transferring power from the transmitter to the line can be approached purely on the basis of the known  $Z_0$  of the line and the maximum SWR that may be encountered.

So far as the transmitter itself is concerned, the requirements of present-day amateur operation almost invariably include complete shielding and provision for the use of low-pass filters to prevent harmonic interference with television reception. In almost all cases this means that the use of coaxial cable at the output of the transmitter is mandatory because it is inherently shielded. Thus the transmitter output circuit should be designed to deliver full power into 50-75 ohms, with enough leeway to take care of reasonable variations in load —

equivalent to the line input-impedance range associated with a 2-to-1 or perhaps as high as 3-to-1 SWR in the line. This does not mean that a coaxial line must be used to feed the *antenna*; any type of line can be used.

#### The Matching System

The basic system then is as shown in Fig. 3-36. Assuming that the transmitter is capable of delivering its rated power into a load of the order of 50 to 75 ohms, the coupling problem is one of designing a matching circuit that will transform the actual line input impedance into a resistance of 50 or 75 ohms. This resistance will be unbalanced — that is, one side will be grounded — but the actual line to the antenna probably will be balanced (parallel-conductor line) when a matching circuit is required. Unbalanced (coaxial) line should not require a matching circuit, since it should be used only when it is sufficiently well matched by the antenna to operate at a low SWR — one well within the coupling capabilities of the transmitter itself.

Several types of matching circuits are available. With some, such as an  $L$  network using fixed-value components, it is necessary to know the actual line-input impedance with fair accuracy in order to arrive at a proper design. This information is not essential with the circuits described in the next section, since they are capable of adjustment over a wide range.

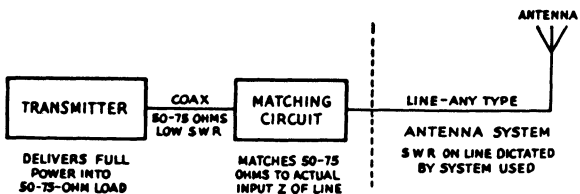

Fig. 3-36 — Essentials of coupling system between transmitter and transmission line.



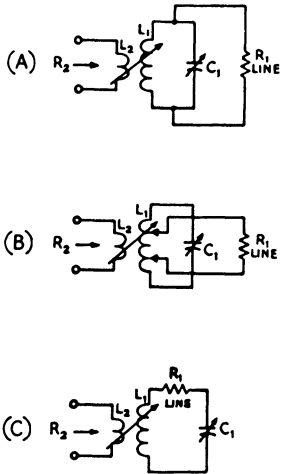

Fig. 3-37 - Circuit arrangements for inductively coupled impedance-matching circuit. A and B use a parallel-tuned coupling tank; B is equivalent to A when the taps are at the ends of L1. The series-tuned circuit at C is useful for very low values of load resistance, R1.

**MATCHING WITH INDUCTIVE COUPLING**

Inductively coupled matching circuits are shown in basic form in Fig. 3-37. R1 is the actual load resistance to which the power is to be delivered, and R2 is the resistance seen by the power source, R2 depends on the circuit design and adjustment; in general, the objective is to make it equal to 50 or 75 ohms. L1 and C1 form a resonant circuit capable of being tuned to the operating frequency. The coupling between L1 and L2 is adjustable.

The circuit formed by C1, L1 and L2 is equivalent to a transformer having a primary-to-secondary impedance ratio adjustable over wide limits. The resistance "coupled into" L2 from L1 depends on the effective Q of the circuit L1-C1-R1, the reactance of L2 at the operating frequency, and the coefficient of coupling, k, between the two coils. The approximate relationship is (assuming C1 is properly tuned)

$$R2 = k^2 X_{L2} Q$$

where  $X_{L2}$  is the reactance of L2 at the operating frequency. The value of L2 is optimum when  $X_{L2} = R2$ , in which case the desired value of R2 is obtained when

$$k = \frac{1}{\sqrt{Q}}$$

This means that the desired value of R2 may be obtained by adjusting either the coupling, k, between the two coils, or by changing the Q of the circuit L1-C1-R1 - or, if necessary, by doing both. If the coupling is fixed, as is often the case, Q must be adjusted to attain a match. Note that increasing

the value of Q is equivalent to tightening the coupling, and vice versa.

If L2 does not have the optimum value, the match may still be obtained by adjusting k and Q, but one or the other - or both - must have a larger value than is needed when  $X_{L2}$  is equal to R2. In general, it is desirable to use as low a value of Q as is practicable, since low Q values mean that the circuit requires little or no readjustment when shifting frequency within a band (provided R1 does not vary appreciably with frequency).

**Circuit Q**

In Fig. 3-37A, Q is equal to R1 in ohms divided by the reactance of C1 in ohms, assuming L1-C1 is tuned to the operating frequency. This circuit is suitable for comparatively high values of R1 - from several hundred to several thousand ohms. In Fig. 3-37C, Q is equal to the reactance of C1 divided by the resistance of R1, L1-C1 again being tuned to the operating frequency. This circuit is suitable for low values of R1 - from a few ohms up to a hundred or so ohms. In Fig. 3-37B the Q depends on the placement of the taps on L1 as well as on the reactance of C1. This circuit is suitable for matching all values of R1 likely to be encountered in practice.

Note that to change Q in either A or C, Fig. 3-37, it is necessary to change the reactance of C1. Since the circuit is tuned essentially to resonance at the operating frequency, this means that the L/C ratio must be varied in order to change Q. In Fig. 3-37B a fixed L/C ratio may be used, since Q can be varied by changing the tap positions. The Q will increase as the taps are moved closer together, and will decrease as they are moved farther apart on L1.

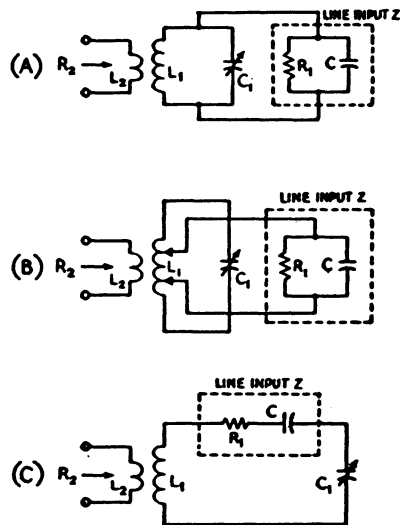

Fig. 3-38 - Line input impedances containing both resistance and reactance can be represented as shown enclosed in dotted lines, for capacitive reactance. If the reactance is inductive, a coil is substituted for the capacitance C.

**Reactive Loads – Series and Parallel Coupling**

More often than not, the load represented by the input impedance of the transmission line is reactive as well as resistive. In such a case the load cannot be represented by a simple resistance, such as  $R_1$  in Fig. 3-37. As stated earlier in this chapter, we have the option of considering the load to be a resistance in parallel with a reactance, or as a resistance in series with a reactance (Fig. 3-15). In Figs. 3-37A and B it is convenient to use the parallel equivalent of the line input impedance. The series equivalent is more suitable for Fig. 3-37C.

Thus in Fig. 3-38 at A and B the load might be represented by  $R_1$  in parallel with the capacitive reactance  $C$ , and in Fig. 3-38C by  $R_1$  in series with a capacitive reactance  $C$ . In A, the capacitance  $C$  is in parallel with  $C_1$  and so the total capacitance is the sum of the two. This is the effective capacitance that, with  $L_1$ , tunes to the operating frequency. Obviously the setting of  $C_1$  will be at a lower value of capacitance with such a load than it would with a purely resistive load such as is shown in Fig. 3-37A.

In Fig. 3-38B the capacitance of  $C$  also increases the total capacitance effective in tuning the circuit. However, in this case the increase in effective tuning capacitance depends on the positions of the taps; if the taps are close together the effect of  $C$  on the tuning is relatively small, but it increases as the taps are moved farther apart.

In Fig. 3-38C, the capacitance  $C$  is in series with  $C_1$  and so the total capacitance is less than either. Hence the capacitance of  $C_1$  has to be increased in order to resonate the circuit, as compared with the purely resistive load shown in Fig. 3-37C.

If the reactive component of the load impedance is inductive, similar considerations apply. In such case an inductance would be substituted for the capacitance  $C$  shown in Fig. 3-38. The effect in Figs. 3-38A and B would be to decrease the effective inductance in the circuit, so  $C_1$  would have to have a larger value of capacitance in order to resonate the circuit to the operating frequency. In Fig. 3-38C the effective inductance would be increased, thus making it necessary to set  $C_1$  at a lower value of capacitance for resonating the circuit.

**Effect of Line Reactance on Circuit  $Q$**

The presence of reactance in the line input impedance can affect the  $Q$  of the matching circuit. If the reactance is capacitive, the  $Q$  will not change if resonance can be maintained by adjustment of  $C_1$  without changing either the value of  $L_1$  or the position of the taps in Fig. 3-38B (as compared with the  $Q$  when the load is purely resistive and has the same value of resistance,  $R_1$ ). If the load reactance is inductive the  $L/C$  ratio changes because the effective inductance in the circuit is changed and, in the ordinary case,  $L_1$  is not adjustable. This increases the  $Q$  in all three circuits of Fig. 3-38.

When the load has appreciable reactance it is not always possible to adjust the circuit to res-

onance by readjusting  $C_1$ , as compared with the setting it would have with a purely resistive load. Such a situation may occur when the load reactance is low compared with the resistance in the parallel-equivalent circuit, or when the reactance is high compared with the resistance in the series-equivalent circuit. The very considerable detuning of the circuit that results is often accompanied by an increase in  $Q$ , sometimes to values that lead to excessively high circulating currents in the circuit. This causes the efficiency to suffer. (Ordinarily the power loss in matching circuits of this type is inconsequential, if the  $Q$  is below 10 and a good coil is used.) An unfavorable ratio of reactance to resistance in the input impedance of the line can exist if the SWR is high and the line length is near an odd multiple of one-eighth wavelength (45 degrees).

**$Q$  of Line Input Impedance**

The ratio between reactance and resistance in the equivalent input circuit – that is, the  $Q$  of the line input impedance – is a function of line length and SWR. There is no specific value of this  $Q$  of which it can be said that lower values are satisfactory while higher values are not. In part, the maximum tolerable value depends on the tuning range available in the matching circuit. If the tuning range is restricted (as it will be if the variable capacitor has relatively low maximum capacitance), compensating for the line input reactance by absorbing it in the matching circuit – that is, by retuning  $C_1$  in Fig. 3-38 – may not be possible. Also, if the  $Q$  of the matching circuit is low the effect of the line input reactance will be

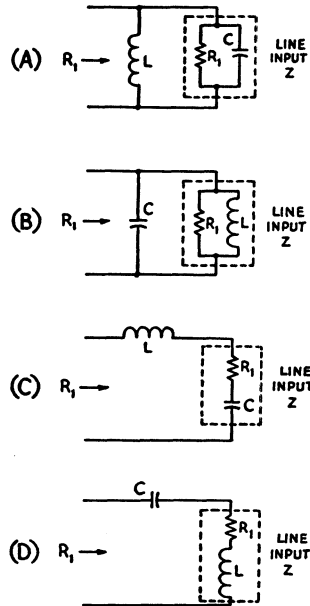

Fig. 3-39 – Compensating for reactance present in the line input impedance.

greater than it will when the matching-circuit  $Q$  is high.

As stated earlier, the optimum matching-circuit design is one in which the  $Q$  is low, i.e., a low reactance-to-resistance ratio.

### Compensating for Input Reactance

When the reactance/resistance ratio in the line input impedance is unfavorable it is advisable to take special steps to compensate for it. This can be done as shown in Fig. 3-39. Compensation consists of supplying external reactance of the same numerical value as the line reactance, but of the opposite kind. Thus in A, where the line input impedance is represented by resistance and capacitance in parallel, an inductance  $L$  having the same numerical value of reactance as  $C$  can be connected across the line terminals to "cancel out" the line reactance. (This is actually the same thing as tuning the line to resonance at the operating frequency.) Since the parallel combination of  $L$  and  $C$  is equivalent to an extremely high resistance at resonance, the input impedance of the line becomes a pure resistance having essentially the same resistance as  $R_1$  alone.

The case of an inductive line is shown at B. In this case the external reactance required is capacitive, of the same numerical value as the reactance of  $L$ .

Where the series equivalent of the line input impedance is used the external reactance is connected in series, as shown at C and D in Fig. 3-39.

In general, these methods need not be used unless the matching circuit does not have sufficient range of adjustment to provide compensation for the line reactance as described earlier, or when such a large readjustment is required that the matching-circuit  $Q$  becomes undesirably high. The latter condition usually is accompanied by heating of the coil used in the matching network.

### Methods for Variable Coupling

The coupling between  $L_1$  and  $L_2$ , Figs. 3-37 and 3-38, preferably should be adjustable. If the coupling is fixed, such as with a fixed-position link, the placement of the taps on  $L_1$  for proper matching becomes rather critical. The additional matching adjustment afforded by adjustable coupling between the coils facilitates the matching procedure considerably.  $L_2$  should be coupled to the center of  $L_1$  for the sake of maintaining balance, since the circuit is used with balanced lines.

If adjustable inductive coupling such as a swinging link is not feasible for mechanical reasons, an alternative is to use a variable capacitor in series with  $L_2$ . This is shown in Fig. 3-40. Varying  $C_2$  changes the total reactance of the circuit formed by  $L_2$ - $C_2$ , with much the same effect as varying the actual mutual inductance between  $L_1$  and  $L_2$ . The capacitance of  $C_2$  should be such as to resonate with  $L_2$  at the lowest frequency in the band of operation. This calls for a fairly large value of capacitance at low frequencies (about 1000 pF at 3.5 MHz for 50-ohm line) if the reactance of  $L_2$

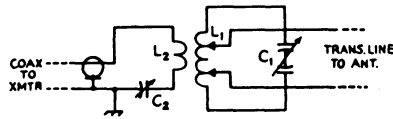

Fig. 3-40 — Using a variable capacitance,  $C_2$ , as an alternative to variable mutual inductance between  $L_1$  and  $L_2$ .

is equal to the line  $Z_0$ . To utilize a capacitor of more convenient size — maximum capacitance of perhaps 250-300 pF — a value of inductance may be used for  $L_2$  that will resonate at the lowest frequency with the maximum capacitance available.

On the higher frequency bands the problem of variable capacitors does not arise since a reactance of 50 to 75 ohms is within the range of conventional components.

### Circuit Balance

Fig. 3-40 shows  $C_1$  as a balanced or split-stator capacitor. This type of capacitor is desirable in a practical matching circuit to be used with a balanced line, since the two sections are symmetrical. In the ordinary single-section capacitor there is more capacitance to ground (or metal objects, such as a chassis, in the vicinity) from the frame and rotor assembly than from the stator assembly. The rotor assembly of the balanced capacitor may be grounded, if desired, or it may be left "floating" and the center of  $L_1$  may be grounded; or both may "float." Which method to use depends on considerations discussed later in connection with antenna currents on transmission lines.

As an alternative to using a split-stator type of capacitor, a single-section capacitor may be used, and a balun employed to couple the matching network to the load. Baluns are discussed in a later section of this chapter.

## A UNIVERSAL MATCHING NETWORK

The circuit shown at A in Fig. 3-41, named the Ultimate Transmatch, may be used as a "universal" matching network. With reasonable component values it will match impedances from quite low values, an ohm or two, to quite high values, several thousand ohms, whether or not reactances are present in the load. Construction details for this type of circuit are given in Chapter Six.

Depending upon the settings of  $C_1$ ,  $C_2$ , and  $L_1$ , the circuit may have a number of equivalents. A basic equivalent is shown at B of Fig. 3-41, where  $R$  and  $C_1$ , together, represent  $C_1$  alone in the drawing at A.  $L_1$  and  $C_1$  form a parallel-resonant circuit; if tuned to resonance at the operating frequency, they may be represented by a pure resistance.  $C_1$ , a differential capacitor, provides the capability of a continuously adjustable tap across the parallel combination of  $C_1$  and  $L_1$ , represented by  $R$  at B.

When the terminating impedance is low, optimum settings for a match will result when the

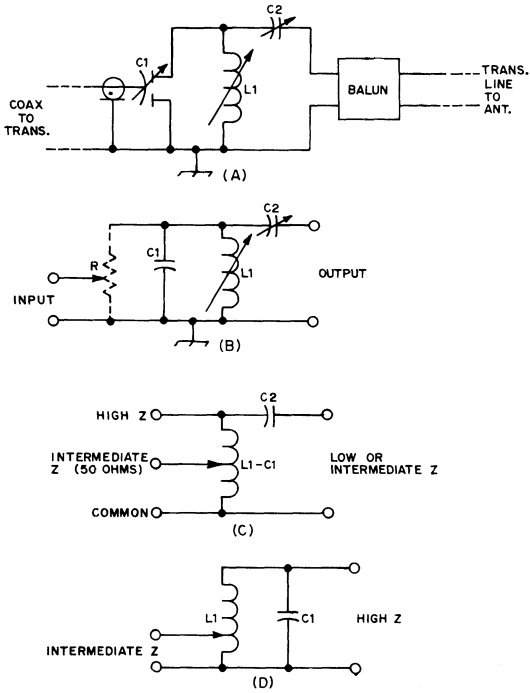

Fig. 3-41 — At A, the Ultimate Transmatch, a universal matching network. At B, C, and D, the various circuit-equivalent configurations which the circuit at A may take, depending on the adjustment settings.

L1-C1 combination is tuned for resonance at a frequency below that of the operating frequency. When so tuned, the combination will be inductive at the operating frequency, represented by a coil in C of Fig. 3-41. The circuit thus takes the equivalent form of an  $L$  network with the input being tapped down on the coil, as shown. (In  $L$ -network matching, the higher of the two impedances to be matched is connected to the shunt-arm side of the network, and the lower impedance to the series-arm side.) Reactances in the load, either inductive or capacitive, may be tuned out with C2. If the load itself contains capacitive reactance, less capacitive reactance (greater capacitance) will be required at C2 than if the load were purely resistive. Conversely, less capacitance will be required for the final setting of C2 if the load contains inductive reactance.

For intermediate values of impedance, such as 50 or 75 ohms, a matching network would not ordinarily be required for most modern transmitters. However, it would be a nuisance in a multiband-antenna and matching-network system if it were necessary to disconnect and remove the matching network for one or two of the bands of operation and reinstall it for the others. If the combination of antenna impedance and feed-line characteristics should happen to present a load to the matching network in this intermediate-impedance range, the circuit of 3-41 may still be

adjusted for a "match." As shown at C, the load impedance is transformed up to a somewhat higher value in the equivalent of an  $L$  network, with the setting of C1 providing the proper "tap" point for the coax-termination impedance to be in the 50-ohm range.

With high-impedance resistive loads, correct matching will be obtained with L1 and C1 resonated near the frequency of operation and with C2 adjusted for maximum capacitance. If the reactance of C2 at the operating frequency is low, less than the total load impedance, the effects of C2 in the circuit may, for the moment, be disregarded. The resulting equivalent circuit is shown at D of Fig. 3-41. The  $Q$ , and thus the impedance of the parallel-resonant circuit, L1-C1, may be adjusted by altering the  $L/C$  ratio of the circuit while maintaining resonance. At the proper settings of L1 and C1, the impedance of the loaded parallel-resonant circuit will equal that of the terminating impedance,  $Z$ , while the effective tap point of differential capacitor C1 will provide a 50-ohm termination for the coax line. Reactances in the load, including the practical effects of having C2 in the circuit, may be tuned out with appropriate settings of L1 and C1 to maintain overall system resonance.

From the above paragraphs, it is easy to visualize that with proper settings of L1, C1, and C2, the circuit of 3-41A will provide a match over the continuous range of impedances between low and high.

## ADJUSTMENT OF MATCHING CIRCUITS

Adjustment of the matching circuit consists in finding the proper settings for the taps on L1 (Fig. 3-40) or for the total inductance (Fig. 3-41), and the proper settings of C1 and C2 (both circuits) so that the line input impedance is transformed into a 50- or 75-ohm load to match the  $Z_0$  of the particular type of coaxial cable used between the transmitter and matching circuit. The surest and by far the simplest way to arrive at the correct adjustments is to use an SWR indicator designed for the type of coax used.

The setup using the SWR bridge is shown in Fig. 3-42. The matching circuit may be that of Fig. 3-40 or 3-41. Adjustments may be made at any convenient power level within the power-handling capabilities of the type of bridge used. Adjust the transmitter output for a "forward" reading on the bridge indicator well up on the indicator scale. Then switch to read reflected power (or voltage, depending on the instrument calibration).

### Adjustment Procedure

To adjust the circuit of Fig. 3-40, set the taps at trial positions equidistant from the center of the coil, then vary C1 for minimum reading on the bridge indicator. Next adjust C2 for the lowest possible reading, then touch up C1 again with the same objective. Continue until the indicator reads zero, or as close to it as possible. If a good null is not obtained, try the taps at another position and

Fig. 3-42 — Adjustment setup using SWR indicator.

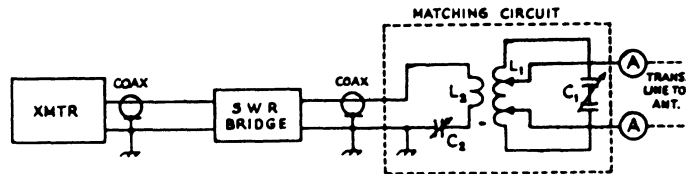

go through the procedure again. In most cases, it will not be necessary to try many tap positions; in fact, it is usually found that the tap positions are not at all critical. If  $C_2$  is not used but the coupling between  $L_1$  and  $L_2$  can be varied, the coupling adjustment takes the place of varying  $C_2$  in the above procedure. If neither  $C_2$  nor adjustable coupling between the coils is used, the tap positions become rather critical. After the initial adjustment of the circuit, try moving the tap positions out toward the ends of  $L_1$  until it is just possible to obtain a match by means of  $C_1$  and  $C_2$  at all frequencies within the band. This will result in the lowest possible operating  $Q$  and thus minimize the necessity for readjustment of the circuit when shifting frequency.

A similar procedure is followed for adjustment of the circuit of Fig. 3-41A. First set  $C_1$  at its midposition and  $C_2$  at maximum capacitance. Then vary  $L_1$ . At some point, a sharp dip will be noted in the reflected power indication. Once this point is found, readjust  $C_1$  and  $C_2$ , with possibly a slight readjustment of  $L_1$ , for zero reflected power. For most loads, the settings will be found to be quite broad for a perfect match. The settings which will result in the lowest operating  $Q$  are those of minimum inductance for  $L_1$  and maximum capacitance for  $C_2$ .

During the course of adjustments of either of the above circuits, switch the SWR indicator back to "forward" occasionally to make sure that this reading is staying well up on the scale. It sometimes happens that an adjustment which apparently reduces the reflected reading to zero or near zero is simply detuning the circuit and the forward reading becomes quite low. The objective is to get a zero reflected reading at matching-circuit settings that also give a high forward reading.

With low  $Q$ , these circuits will work over an entire band without readjustment if the load is constant over the same frequency range. The load seldom stays constant, however, since the input impedance of the line changes with frequency with most antennas. Readjustment becomes necessary whenever the input impedance changes enough to result in poor operation. Evidence of this is either the inability to adjust the transmitter output circuit for proper loading of the final amplifier, or such a high SWR in the coax that it shows signs of heating from the power lost in it.

#### Measurement of Line Input Current

The rf ammeters shown in Fig. 3-42 are not essential to the adjustment procedure but they, or some other form of output indicator, are useful accessories. In most cases the circuit adjustments that lead to a match as shown by the SWR

indicator will also result in the most efficient power transfer to the transmission line. However, it is possible that a good match will be accompanied by excessive loss in the matching circuit. This is unlikely to happen if the steps described for obtaining a low  $Q$  are taken. If the settings are highly critical and/or it is impossible to obtain a match, the use of additional reactance compensation as described earlier is indicated.

Rf ammeters are useful for showing the comparative output obtained with various matching-network settings, and also for showing the improvement in output resulting from the use of reactance compensation when it seems to be required. Providing no basic circuit changes (such as grounding or ungrounding some part of the matching circuit) are made during such comparisons, the current shown by the ammeters will increase whenever the power put into the line is increased. Thus, the highest reading indicates the greatest transfer efficiency, assuming that the power input to the transmitter is kept constant.

If the line  $Z_0$  is matched by the antenna, the current can be used to determine the actual power input to the line. The power at the input terminals is then equal to  $I^2 Z_0$ , where  $I$  is the current and  $Z_0$  is the characteristic impedance of the line. If there are standing waves on the line this relationship does not hold. In such a case the current that will flow into the line is determined by the line length, SWR, and whether the antenna impedance is higher or lower than the line impedance. Fig. 3-26 shows how the maximum current to be expected will vary with the standing-wave ratio. This information can be used in selecting the proper ammeter range.

Two ammeters, one in each line conductor, are shown in Fig. 3-42. The use of two instruments gives a check on the line balance, since the currents should be the same. However, a single meter can be switched from one conductor to the other. If only one instrument is used it is preferably left out of the circuit except when adjustments are being made, since it will add capacitance to the side in which it is inserted and thus cause some unbalance. This is particularly important when the instrument is mounted on a metal panel.

Since the resistive component of the input impedance of a line operating with an appreciable SWR is seldom known accurately, the rf current is of little value as a check on power input to such a line. However, it shows in a relative way the efficiency of the system as a whole. The set of coupling adjustments that results in the largest line current with the least final-amplifier plate current is the one that delivers the greatest power to the antenna with the lowest plate-power input.

For adjustment purposes, it is possible to substitute small flashlamps, shunted across a

few inches of the line wires, for the rf ammeters. Their relative brightness shows when the current increases or decreases. They have the advantage of being inexpensive and of such small physical size that they do not unbalance the circuit,

**Coaxial-Line Feed**

As mentioned earlier, a matching circuit should not be necessary when coaxial line is used to feed the antenna, since the SWR on such lines already should be low enough to permit satisfactory adjustment of the coupling by the normal transmitter controls. However, there are cases where the additional frequency selectivity provided by the matching circuit is desirable. For example, a coax-fed multiband antenna system will not discriminate against transmitter harmonics, since the system is designed to accept harmonically related amateur frequencies without individual tuning adjustments.

The circuit of Fig. 3-40 may be altered slightly for use with coaxial lines. C1 may be made a single-section capacitor, and the lower tap on L1 is connected to the lower junction of L1 and C1. It is this junction where the shield of the coaxial line is connected, with the center conductor of the line connected to the upper, moveable tap.

The circuit of Fig. 3-41A may be used without the balun for coaxial lines. In either circuit, adjustment is made in the same way as described for the case of a balanced line.

**BALUN COILS**

In Fig. 3-43, L1 is a bifilar winding with an air core. When considered as a pair of parallel conductors, it is equivalent to a transmission line. To a voltage applied between the two terminals at one

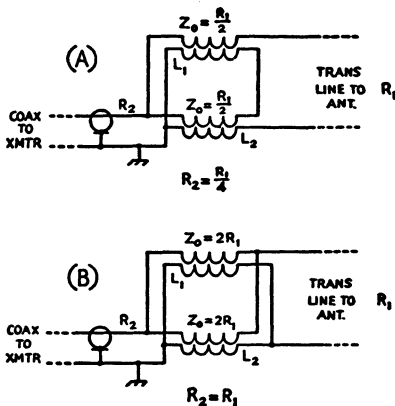

Fig. 3-43 — Air-core balun coils as an impedance-matching device for coupling between balanced and unbalanced lines. A properly designed set of coils will work over the 3.5-30-MHz range without adjustment. However, only the fixed impedance ratios shown are available and the input impedance of the transmission line must be a pure resistance that will match the Z0 of the coils.

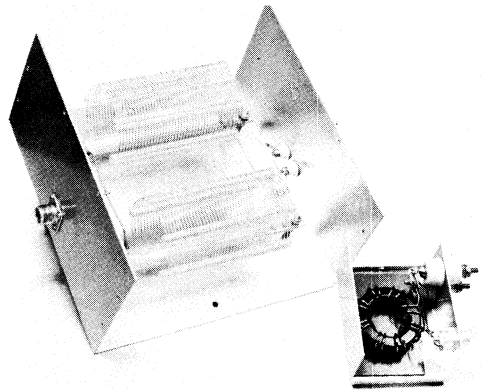

Fig. 3-44 — Air-core balun and toroidal transformer balun. The enclosure for the air-core version measures five inches high by nine inches square; this balun is rated to handle 250 watts. The toroidal balun is built into a 2 X 3 X 3-1/2-inch enclosure, and will handle a full kilowatt. An Amidon T-200-2 core is used in this toroidal balun; a piece of phenolic insulating board is epoxy cemented between the transformer and the enclosure to prevent short-circuiting. (Amidon Associates, 12033 Otsego St., N. Hollywood, CA 91601.)

end of the winding, the inductance of the winding considered as a plain coil is unimportant, since the currents in the two conductors will be equal and opposite and there is substantially complete cancellation of the external field just as in a normal transmission line. The parallel conductors have a characteristic impedance dependent on their diameter and spacing, L2 is an identical winding.

If the two windings are connected as shown at A, the two transmission lines are in series at the right-hand end and in parallel at the left-hand end. If each has a characteristic impedance equal to half the input resistance of the balanced transmission line to the antenna, their Z0 will be matched by the line input resistance, and the resistance looking into the left-hand end of each will be equal to its own Z0. Since they are in parallel at the left-hand end, the total resistance looking into the windings toward the antenna is equal to half the Z0 of either line, or one-fourth R1.

This arrangement therefore acts as an impedance transformer having a fixed ratio of 4 to 1, balanced on the high-impedance side and unbalanced on the low-impedance side. Since a ratio of 4 to 1 happens also to be the ratio between matched 300-ohm twin line and 75-ohm coaxial line, such a balancing circuit or balun is useful for matching a flat 300-ohm line to 75-ohm coax.

For parallel or "antenna" currents on the transmission line to the antenna (see later section in this chapter) the two pairs of windings act as normal inductances, since such currents are in phase in the two line wires. They thus tend to choke off parallel currents. This choking action also is essential to keep the right-hand end of the lower conductor of L2 properly above ground for a

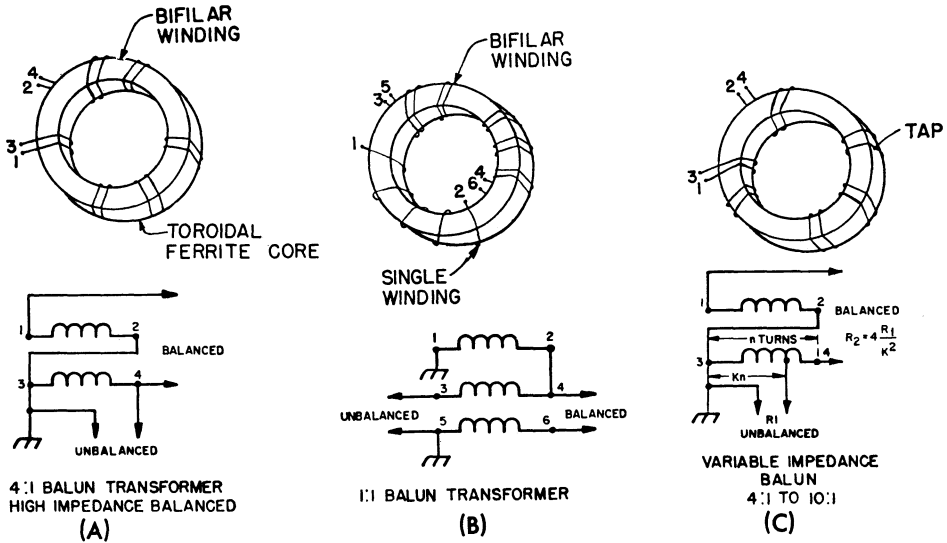

Fig. 3-45 — Basic broad-band balun transformers.

balanced output. Thus the coils must be sufficiently large to give good isolation between the balanced and unbalanced ends at the lowest frequency to be used. The upper frequency limit is that at which the winding, considered as an inductance rather than a transmission line, begins to show distributed-capacitance effects. In practice, a single set of coils can be designed to work over the 3.5- to 30-MHz range. Design is complicated because there is mutual coupling between turns, which modifies the characteristic impedance. However, suitable units are available commercially (B&W 3975).

### Balun Transformers

Because of their smaller physical size for comparable power-handling capability, bifilar-wound baluns on a toroidal core are preferred in practice over air-core baluns. The two types are pictured in Fig. 3-44. Typically, ferrite toroidal-core baluns have bandwidths of 10 to 1, such as for the frequency range from 3 to 30 MHz, and may be constructed sufficiently large to handle the full legal amateur power. Toroidal or transformer baluns are shown in Fig. 3-45. At A is a basic 4:1 transformer balun, with the high impedance balanced. Only two windings are required for this type of balun.

Transformer baluns having a 1:1 impedance ratio are usually trifilar wound — three windings interlaced on the core. The 1:1 balun shown in B of Fig. 3-45 has been modified slightly from that design in that the third winding on the core has been separated from the bifilar winding. This modification results in improved balance at the higher frequencies with no change in other characteristics. The third winding is a core-magnetizing winding which is effective only in extending the low-frequency range of the balun. The third winding may be omitted entirely if operation is confined to frequencies above about 10 MHz.

At C of Fig. 3-45 is shown how the basic 4:1 balun may be altered for impedance matching in the range between 4:1 and 10:1. This is accomplished by tapping the unbalanced input down on one of the two windings. In the formula associated with Fig. 3-45C for determining the impedance ratio,  $k$  equals the ratio of the number of tapped turns to the total number of turns in the tapped winding.

Bifilar windings for balun transformers should be from six to ten turns, depending on the ferrite-core permeability. A suitable ferrite material is Ferramic Q1 (Indiana General), with a permeability of 125. Very small size cores may be used for receiving and low-power applications. For full-power use, 2-1/2-inch OD Ferramic Q1 core with 1/2-inch cross section wound with No. 14 Formex copper wire, seven turns per winding, is recommended.

### Balun Terminations

The principles on which baluns operate should make it obvious that the termination must be essentially a pure resistance in order for the proper impedance transformation to take place. If the termination is not resistive, the input impedance of each bifilar winding will depend on its electrical characteristics and the input impedance of the main transmission line; in other words, the impedance will vary just as it does with any transmission line, and the transformation ratio likewise will vary over wide limits.

Baluns alone are convenient as matching devices when the above condition can be met, since they require no adjustment. When used with a matching network as described earlier, however, the impedance-transformation ratio of a balun becomes of only secondary importance, and loads containing reactance may be tolerated so long as the losses in the balun itself do not become excessive.

## "TUNED" AND "UNTUNED" LINES

In the past, transmission lines frequently have been classified as "tuned" or "untuned," depending on whether or not the line had to be cut to a certain length in order to have a substantially resistive input impedance. As shown earlier, when the SWR is high, the input impedance is resistive (or mostly so) only at line lengths that are a multiple of a quarter wavelength, assuming the load represented by the antenna is itself a substantially pure resistance. (If it is not, the resistive-input points correspond to the current and voltage loops, the first of which may occur at any distance up to a quarter wavelength from the antenna,

depending on the antenna impedance. After the first loop, the remaining ones are at quarter-wavelength intervals.)

Such a classification tends to be arbitrary, since there is no well-defined value of SWR below which a line may be "untuned" and above which it must be "tuned." It is possible to couple power into *any* length of line, regardless of the standing-wave ratio, if the principles already outlined are followed. If the SWR is high, special methods of reactance compensation may be required if the line length is unfavorable, as explained earlier, but it is not *necessary* to cut the line to a particular length (which may be an inconvenient length for installation) in order to put power into it.

## COUPLING THE LINE TO THE ANTENNA

Throughout the discussion of transmission-line principles in the first part of this chapter the operation of the line has been described in terms of an abstract "load." This load had the electrical properties of resistance and, sometimes, reactance. It did not, however, have any physical attributes that associated it with a particular electrical device. That is, it could be anything at all that exhibits electrical resistance and/or reactance. The fact is that so far as the line is concerned, it does not matter what the load *is*, just so long as it will accept power.

Many amateurs make the mistake of confusing transmission lines with antennas, believing that because two identical antennas have different kinds of lines feeding them, or the same kind of line with different methods of coupling to the antenna, the "antennas" are different. There may be practical reasons why one system (including antenna, transmission line, and coupling method) may be preferred over another in a particular application. But to the transmission line, an antenna is just a load that terminates it, and the important thing is what that load looks like to the line in terms of resistance and reactance.

*Any* kind of transmission line can be used with *any* kind of antenna, if the proper measures are taken to couple the two together.

### Frequency Range and SWR

Probably the principal factor that determines the way a transmission line is operated is the frequency range over which the antenna is to work. Very few types of antennas will present essentially the same load impedance to the line on harmonically related frequencies. As a result, the builder often is faced with choosing between (1) an antenna system that will permit operating the transmission line with a low standing-wave ratio, but is confined to one operating frequency or a narrow band of frequencies, and (2) a system that will permit operation in several harmonically related bands but with a large SWR on the line. (There are "multiband" systems which, in principle, make one antenna act as though it were a half-wave dipole on each of several amateur bands, by using

"trap" circuits or multiple wires. Information on these is given in later chapters. Such an antenna can be assumed to be equivalent to a resonant half-wave dipole on each of the bands for which it is designed, and may be fed through a line, coaxial or otherwise, that has a  $Z_0$  matching the antenna impedance, as described later in this chapter for simple dipoles.)

Methods of coupling the line to the antenna therefore divide, from a practical standpoint, into two classes. In the first, operation on several amateur bands is the prime consideration and the standing-wave ratio is secondary. The SWR is normally rather large and the input impedance of the line depends on the line length and the operating frequency.

In the second class, a conscious attempt is made, when necessary, to transform the antenna impedance to a value that matches the characteristic impedance of the line. When this is done the line operates with a very low standing-wave ratio and its input impedance is essentially a pure resistance, regardless of the line length. A transmission line can be considered to be "flat," within practical limits, if the SWR is not more than about 1.5 to 1.

### Losses

A principal reason for matching the antenna to the line impedance is that a flat line operates with the least power loss. While it is always desirable to reduce losses and thus increase efficiency, the effect of standing waves in this connection can be overemphasized. This is particularly true at the lower amateur frequencies, where the inherent loss in most types of lines is quite low even for runs that, in the average amateur installation, are rather long.

For example, 100 feet of 300-ohm receiving-type Twin-Lead has a loss of only 0.18 dB at 3.5 MHz, as shown by Table 3-1. Even with an SWR as high as 10 to 1 the additional loss caused by standing waves is less than 0.7 dB, from Fig. 3-23. Since 1 dB represents the minimum detectable change in signal strength, it does not matter from this standpoint whether the line is flat or not. But



at 144 MHz the loss in the same length of line perfectly matched is 2.8 dB, and an SWR of 10 to 1 would mean an *additional* loss of 4 dB. At the higher frequency, then, it is worthwhile to match the antenna and line as closely as possible.

#### Power Limitations

Another reason for matching is that certain types of lines, particularly those with solid dielectric, have definite voltage and current limitations. At the lower frequencies this is a far more compelling reason than power loss for at least approximate matching. Where the voltage and current must not exceed definite maximum values, the amount of power that the line can handle is inversely proportional to the standing-wave ratio. If the safe rating on the 300-ohm line in the example above is 500 watts when perfectly matched, the line can handle only 50 watts with equal safety when the SWR is 10 to 1. Thus, despite the fact that the line losses are low enough to make no appreciable difference in the signal strength, the high SWR could be tolerated only with low-power transmitters.

#### Line Radiation

Aside from power considerations, there is a more-or-less common belief that a flat line "does not radiate" while one with a high SWR does radiate. This impression is quite unjustified. It is true that the radiation from a parallel-conductor line increases with the current in the line, and that the effective line current increases with the SWR. However, the loss by radiation from a properly balanced line is so small (and is, furthermore, independent of the line length) that multiplying it several times still does not bring it out of the "negligible" classification.

Whenever a line radiates it is because of faulty installation (resulting in unbalance with parallel-conductor lines) or "antenna currents" on the line. Radiation from the latter cause can take place from either resonant or nonresonant lines, parallel-conductor or coaxial.

#### UNMATCHED SYSTEMS

In many multiband systems or simple antennas where no attempt is made to match the antenna impedance to the characteristic impedance of the line, the customary practice is to connect the line either to the center of the antenna (center feed) as indicated in Fig. 3-46A, or to one end (end feed) as shown in Fig. 3-46B.

Because the line operates at a rather high standing-wave ratio, the best type to use is the open-wire line. Solid Twin-Lead of the 300-ohm receiving variety can also be used, but the power limitations discussed in the preceding section should be kept in mind. Although the manufacturers have placed no power rating on receiving-type 300-ohm line, it seems reasonable to make the assumption, based on the conductor size, that a current of 2 A can readily be carried by a line installed so that there is free air circulation about it. This corresponds to a power of 1200 watts in a

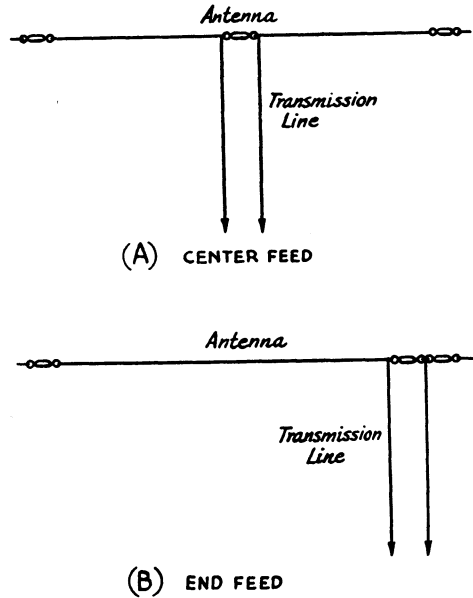

Fig. 3-46 — Center and end feed as used in simple antenna systems.

matched 300-ohm line. When there are standing waves, the safe power can be found by dividing 1200 by the SWR. In a center-fed half-wave antenna, as in Fig. 3-46A, the SWR should not exceed about 5 to 1 (at the fundamental frequency), so receiving type 300-ohm Twin-Lead would appear to be safe for power outputs up to 250 watts or so.

Since there is little point in using a mismatched line to feed an antenna that is to operate on one amateur band only, the discussion to follow will be based on the assumption that the antenna is to be operated on its harmonics for multiband work.

#### "Current" and "Voltage" Feed

Usual practice is to connect the transmission line to the antenna at a point where either a current or voltage loop occurs. If the feed point is at a current loop the antenna is said to be current fed; if at a voltage loop the antenna is voltage fed.

These terms should not be confused with center feed and end feed, because they do not necessarily have corresponding meanings. There is always a voltage loop at the end of a resonant antenna, no matter what the number of half wavelengths, so a resonant end-fed antenna is always voltage fed. This is illustrated at D and E in Fig. 3-47 for end-fed antennas a half wavelength long (antenna fundamental frequency) and one wavelength long (second harmonic). It would continue to be true for an end-fed antenna operated on any harmonic. However, Fig. 3-47F shows voltage feed at the *center* of the antenna; in this case the antenna has a total length of two half wavelengths, each of which is voltage fed. Voltage feed is determined not by the physical position of the transmission

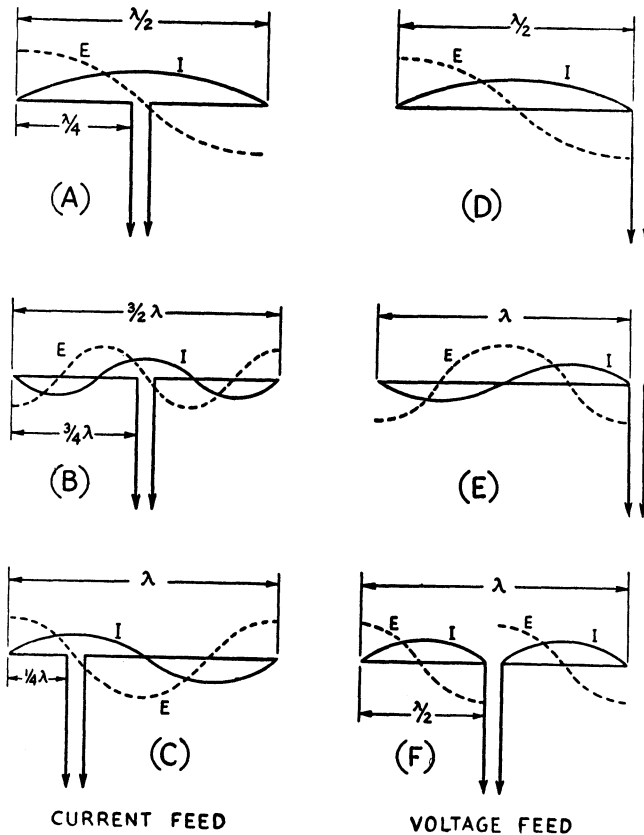

Fig. 3-47 — Current and voltage feed in antennas operated at the fundamental frequency, 2 times the fundamental, and 3 times the fundamental. The current and voltage distribution on the antenna are identical with both methods only at the fundamental frequency.

line on the antenna, but by the fact that a voltage loop occurs on the antenna at the feed point. Since voltage loops always occur at integral multiples of a half wavelength from either end of a resonant antenna, feeding the antenna at any half-wavelength point constitutes voltage feed.

Typical cases of current feed are shown at A, B and C in Fig. 3-47. The feed point is at a current loop, which always occurs at the midpoint of a half-wave section of the antenna. In order to feed at a current loop the transmission line must be connected at a point that is an odd multiple of quarter wavelengths from either end of the resonant antenna. A center-fed antenna is also current fed *only* when the antenna length is an *odd* multiple of half wavelengths. Thus the antenna in Fig. 3-47B is both center fed and current fed since it is three half wavelengths long. It would also be center fed and current fed if it were five, seven, etc., half wavelengths long.

To current feed a one-wavelength antenna, or any resonant antenna having a length that is an *even* multiple of one-half wavelength, it is necessary to shift the feed point from the center of the antenna (where a voltage loop always occurs in such a case) to the middle of one of the half-wave sections. This is indicated in Fig. 3-47C in the case of a one-wavelength antenna; current feed can be used if the line is connected to the antenna at a point  $1/4$  wavelength from either end.

### Operation on Harmonics

In the usual case of an antenna operated on several bands, the point at which the transmission line is attached is of course fixed. The antenna length is usually such that it is resonant at some frequency in the lowest frequency band to be used, and the transmission line is connected either to the center or the end. The current and voltage distribution along antennas fed at both points is shown in Fig. 3-48. With end feed, A to F inclusive, there is always a voltage loop at the feed point. Also, the current distribution is such that in every case the antenna operates as a true harmonic radiator of the type described in Chapter Two.

With center feed, the feed point is always at a current loop on the fundamental frequency and all *odd* multiples of the fundamental. In these cases the current and voltage distribution are identical with the distribution on an end-fed antenna. This can be seen by comparing A and G, C and I, and E and K, Fig. 3-48. (In I, the phase is reversed as compared with C, but this is merely for convenience in drawing; the actual phases of the currents in each half-wave section reverse each half cycle so it does not matter whether the current curve is drawn above or below the line, so long as the *relative* phases are properly shown in the same antenna.) On odd multiples of the fundamental frequency, therefore, the antenna operates as a true harmonic antenna.

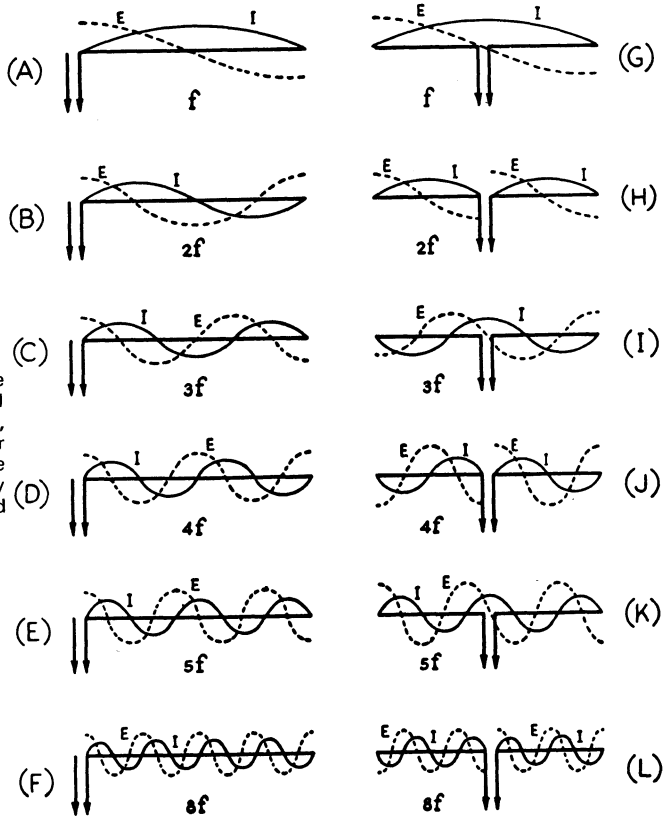

Fig. 3-48 — Current and voltage distribution at the fundamental frequency and various multiples, with both end feed and center feed. The distributions are the same with both types of feed only when the frequency is an odd multiple of the fundamental.

On *even* multiples of the fundamental frequency the feed point with center feed is always at a voltage loop. This is shown at H, J and L in Fig. 3-48. Comparing B and H, it can be seen that the current distribution is different with center feed than with end feed. With center feed the currents in both half-wave sections of the antenna are in the same phase, but with end feed the current in one half-wave section is in reverse phase to the current in the other. This does not mean that one antenna is a better radiator than the other, but simply that the two will have different directional characteristics. The center-fed arrangement is commonly known as “two half-waves in phase,” while the end-fed system is a “one-wavelength antenna” or “second-harmonic” antenna.

Similarly, the system at J has a different current and voltage distribution than the system at D, although both resonate at four times the fundamental frequency. A similar comparison can be made between F and L. The center-fed arrangement at J really consists of two one-wavelength antennas, while the arrangement at L has two 2-wavelength antennas. These have different directional characteristics than the 2-wavelength and 4-wavelength antennas (D and F) that resonate at the same multiple, respectively, of the fundamental frequency.

The reason for this difference between odd and even multiples of the fundamental frequency in the

case of the center-fed antenna can be explained with the aid of Fig. 3-49. It will be recalled from Chapter Two that the direction of current flow reverses in each half wavelength of wire. Also, in any transmission line the currents in the two wires always must be equal and flowing in opposite directions at any point along the line. Starting from the end of the antenna, the current must be flowing in one direction throughout the first half-wavelength section, whether this section is entirely antenna or partly antenna and partly one wire of the transmission line. Thus, in A, Fig. 3-49, the current flows in the same direction from P to Q, since this is all the same conductor. However, one quarter wave is in the antenna and one in the transmission line. The current in the other line wire, starting from R, must flow in the opposite direction in order to balance the current in the first wire, as shown by the arrow. And since the distance from R to S is 1/2 wavelength, the current continues to flow in the same direction all the way to S. The currents in the two halves of the *antenna* are therefore flowing in the same direction. Furthermore, the current is maximum 1/4 wavelength from the ends of the antenna, as previously explained, and so both the currents are maximum at the junction of the antenna and transmission line. This makes the current distribution along the length of the antenna exactly the same as with an end fed antenna.

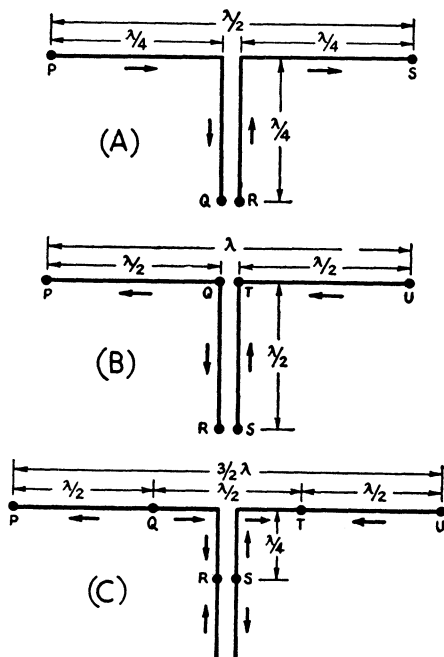

Fig. 3-49 — Showing how the type of feed changes from current to voltage, with a center-fed antenna, on twice the fundamental frequency, and back to current feed on three times the fundamental. The same change occurs between all even and odd frequency multiples.

Fig. 3-49B shows the case where the overall length of the antenna is one wavelength, making a half wave on each side. A half wavelength along the transmission line also is shown. If we assume that the current is flowing downward in the line conductor from  $Q$  to  $R$ , it must be flowing upward from  $S$  to  $T$  if the line currents are to balance. However, the distance from  $Q$  to  $P$  is  $1/2$  wavelength, and so the current in this section of the antenna must flow in the opposite direction to the current flowing in the section from  $Q$  to  $R$ . The current in section  $PQ$  is therefore flowing away from  $Q$ . Also, the current in section  $TU$  must be flowing in the opposite direction to the current in  $ST$ , and so is flowing toward  $T$ . The currents in the two half-wave sections of the antenna are therefore flowing in the same direction. That is, they are in the same phase.

With the above in mind, the direction of current flow in a  $1\text{-}1/2$ -wavelength antenna, Fig. 3-49C, should be easy to follow. The center half-wave section  $QT$  corresponds to the half-wave antenna in A. The currents in the end sections,  $PQ$  and  $TU$  simply flow in the opposite direction to the current in  $QT$ . Thus the currents are out of phase in alternate half-wave sections.

The shift in voltage distribution between odd and even multiples of the fundamental frequency can be demonstrated by a similar method, making allowance for the fact that the voltage is maximum where the current is minimum, and vice versa. On

all even multiples of the fundamental frequency there is a current minimum at the junction of the line and antenna, with center feed, because there is an integral number of half wavelengths in each side of the antenna. The voltage is maximum at the junction in such a case, and we have voltage feed. Where the multiple of the fundamental is odd, there is always a current maximum at the junction of the transmission line and antenna, as demonstrated by A and C in Fig. 3-49. At these points the voltage is minimum and we therefore have current feed.

### “Zepp” or End Feed

In the early days of short-wave communication an antenna consisting of a half-wave dipole, ended through a  $1/4$ -wavelength transmission line, was developed as a trailing antenna for Zeppelin airships. In its utilization by amateurs, over the years, it has become popularly known as the “Zeppelin” or “Zepp” antenna. The term is now applied to practically any resonant antenna fed at the end by a two-wire transmission line.

The mechanism of end feed is perhaps somewhat difficult to visualize, since only one of the two wires of the transmission line is connected to the antenna while the other is simply left free. The difficulty lies in the natural tendency to think in terms of current flow in ordinary electrical circuits, where it is necessary to have a complete loop between both terminals of the power source before any current can flow at all. But as explained earlier, this limitation applies only to circuits in which the electromagnetic fields reach the most distant part of the circuit in a time interval that is negligible in comparison with the time of one cycle. When the circuit dimensions are comparable with the wavelength, no such complete loop is necessary. *The antenna itself is an example of an “open” circuit in which large currents can flow.*

One way of looking at end feed is to consider the entire length of wire, including both antenna and feeder, as a single unit. For example, suppose we have a wire one wavelength long, as in Fig. 3-50A, fed at a current loop by a source of rf power. The current distribution will be as shown by the curves, with the assumed directions indicated by the arrows. If we now fold back the  $1/4$ -wavelength section to the left of the power source, as shown at B, the overall current distribution will be similar, but the currents in the two wires of the folded section will be flowing in opposite directions. The amplitudes of the currents at any point along the folded-back portion will be equal in the two wires. The folded section, therefore, has become a  $1/4$ -wavelength transmission line, since the fields from the equal and opposite currents cancel. There is, however, nothing to prevent current from continuing to flow in the right-hand half-wavelength section, since there was current there before the left-hand section was folded.

This picture, although showing how power can flow from the transmission line to an antenna through end feed, lacks completeness. It does not take into account the fact that the current  $I_1$  in

the transmission line is greatly different from the current  $I$  in the antenna. A more basic viewpoint is the one already mentioned in Chapter Two: The current is caused by electromagnetic fields traveling along the wire and simply constitutes a measurable manifestation of those fields; the current does not cause the fields. From this standpoint the transmission-line conductors merely serve as "guides" for the fields so the electromagnetic energy will go where we want it to go. When the energy reaches the end of the transmission line it meets another guide, in the form of the antenna, and continues along it. However, the antenna is a different form of guide; it has a single conductor while the line has two; it has no provision for preventing radiation while the line is designed for that very purpose. This is simply another way of saying that the impedance of the antenna differs from that of the transmission line, so there will be reflection when the energy traveling along the line arrives at the antenna. We are then back on familiar ground, in that we have a transmission line terminated in an impedance different from its characteristic impedance.

### Feeder Unbalance

With end feed, the currents in the two line wires do not balance exactly and there is therefore some radiation from the line. The reason for this is that the current at the end of the free wire is zero (neglecting a small charging current in the insulator at the end) while the current does not go to zero at the junction of the "active" line wire and the antenna. This is because not all the energy going into the antenna is reflected back from the far end, some being radiated; hence the incident and reflected currents cannot completely cancel at a node.

In addition to this unavoidable line radiation a further unbalance will occur if the antenna is not exactly resonant at the operating frequency. If the frequency is too high (antenna too long) the current node does not occur at the junction of the antenna and "live" feeder, but moves out on the antenna. When the frequency is too low the node moves down the active feeder. Since the node on the free feeder has to occur at the end, either case is equivalent to shifting the position of the standing wave along one feeder wire but not the other. The further off resonance the antenna is operating, the greater the unbalance and the greater the line radiation. With center feed this unbalance does not occur, because the system is symmetrical with respect to the line.

To avoid line radiation it is always best to feed the antenna at its center of symmetry. In the case of simple antennas for operation in several bands, this means that center feed should be used. End feed is required only when the antenna is operated on an even harmonic to obtain a desired directional characteristic, and then only when it must be used on more than one band. For single-band operation it is always possible to feed an even-harmonic antenna at a current loop in one of the half-wave sections nearest the center.

### SWR with Wire Antennas

When a line is connected to a single-wire antenna at a current loop the standing-wave ratio can be estimated with good-enough accuracy with the aid of the curve in Fig. 2-20. Although the actual value of the radiation resistance, as measured at a current loop, will vary with the height of the antenna above ground, the theoretical values given in Fig. 2-20 will at least serve to establish whether the SWR will be high or low.

With center feed the line will connect to the antenna at a current loop on the fundamental frequency and all odd multiples, as shown by Fig. 3-48. At the fundamental frequency and usual antenna heights, the antenna resistance should lie between 50 and 100 ohms, so with a line having a characteristic impedance of 450 ohms the SWR will be  $Z_0/R_L = 450/50 = 9$  to 1 as one limit, and  $450/100 = 4.5$  to 1 as the other. On the third harmonic the theoretical resistance as given by Fig. 2-20 is near 100 ohms, so the SWR should be about 4.5 to 1. For 300-ohm line the SWR can be expected to be between 3 and 6 on the antenna fundamental and about 3 to 1 on the third harmonic.

The impedances to be expected at voltage loops are less readily determined. Theoretical values are in the neighborhood of 5000 to 8000 ohms, depending on the antenna conductor size and the number of half wavelengths along the wire. Such experimental figures as are available indicate a lower order of resistance, with measurements and estimates running from 1000 to 5000 ohms. In any event, there will be some difference between end feed and center feed, since the current distribution on the antenna is different in these two cases at any given even multiple of the fundamental frequency. Also, the higher the multiple the lower the resistance at a voltage loop, so the SWR can be expected to decrease when an antenna is operated at a high multiple of its fundamental frequency. Assuming 4000 ohms for a wire antenna two half waves long, the SWR would be about 6 or 7 with a 600-ohm line and around 12 with a 300-ohm line. However, considerable variation is to be expected.

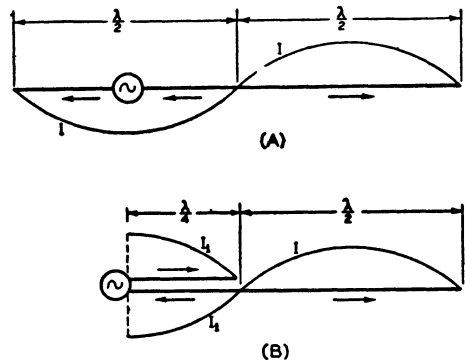

Fig. 3-50 — Folded-antenna analogy of transmission line for an end-fed antenna.

## ANTENNA CURRENTS ON TRANSMISSION LINES

In any discussion of transmission-line operation it is always assumed that the two conductors carry equal and opposite currents throughout their length. This is an ideal condition that may or may not be realized in practice. In the average case the chances are rather good that the currents will *not* be balanced unless special precautions are taken. Whether the line is matched or not has little to do with the situation.

Consider the half-wave antenna shown in Fig. 3-51 and assume that it is somehow fed by a source of power at its center, and that the instantaneous direction of current flow is as indicated by the arrows. In the neighborhood of the antenna is a group of conductors disposed in various ways with respect to the antenna itself. All of these conductors are in the field of the antenna and are therefore coupled to it. Consequently, when current flows in the antenna a voltage will be induced in each conductor. This causes a current flow determined by the induced voltage and the impedance of the conductor.

The degree of coupling depends on the position of the conductor with respect to the antenna, assuming that all the conductors in the figure are the same length. The coupling between the antenna and conductor *IJ* is greater than in any other case, because *IJ* is close to and parallel with the antenna. Ideally, the coupling between conductor *GH* and the antenna is zero, because the voltage induced by current flowing in the left-hand side of the antenna is exactly balanced by a voltage of opposite polarity induced by the current flowing in the right-hand side. This is because the two currents are flowing in opposite directions with respect to *GH*. Complete cancellation of the induced voltages can occur, of course, only if the currents in the two halves of the antenna are symmetrically distributed with respect to the center of the antenna, and also only if every point along *GH* is equidistant from any two points along the antenna that are likewise equidistant from the center. This cannot be true of any of the other conductors shown, so a finite voltage will be induced in any conductor in the vicinity of the antenna except one perpendicular to the antenna at its center.

### Transmission Line in the Antenna Field

Now consider the two conductors *EF* and *KL*, which are parallel and very close together. Except

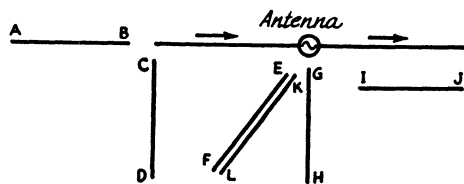

Fig. 3-51 — Coupling between antenna and conductors in the antenna's field.

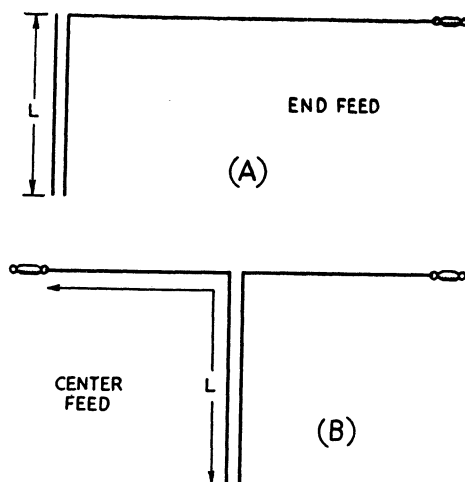

Fig. 3-52 — The important length for resonance to antenna currents coupled from the antenna to the line. In the center-fed system one side of the antenna is part of the "parallel"-resonant system.

for the negligible spacing between them, the two conductors lie in the same position with respect to the antenna. Therefore, identical voltages will be induced in both, and the resulting currents will be flowing *in the same direction in both conductors*. It is only a short step to visualizing conductors *EF* and *KL* as the two conductors of a section of transmission line in the vicinity of the antenna. Because of coupling to the antenna, it is not only possible but *certain* that a voltage will be induced in the two conductors of the transmission line in parallel. The resulting current flow is in the same direction in both conductors, whereas the true transmission line currents are always flowing in opposite directions at each point along the line. These "parallel" currents are of the same nature as the current in the antenna itself, and hence are called "antenna" currents on the line. They are responsible for most of the radiation that takes place from transmission lines.

When there is an antenna current of appreciable amplitude on the line it will be found that not only are the line currents unbalanced but the apparent SWR is different in each conductor, and that the loops and nodes of current in one wire do not occur at corresponding points in the other wire. Under these conditions it is impossible to measure the true SWR.

It should be obvious from Fig. 3-51 that only in the case of a center-fed antenna can the coupling between the line and antenna be reduced to zero. There is always some such coupling when the antenna is end fed, so there is always the possibility that antenna currents of appreciable amplitude will exist on the line, contributing further to the inherent line unbalance in the end-fed arrangement. But the center-fed system also will have appreciable antenna-to-line coupling if the line is not brought off at right angles to the antenna for a distance of at least a half wavelength.

Antenna currents will be induced on lines of any type of construction. If the line is coax, the antenna current flows only on the *outside* of the outer conductor; no current is induced *inside* the line. However, an antenna current on the outside of coax is just as effective in causing radiation as a similar current induced in the two wires of a parallel-conductor line.

### Detuning the Line for Antenna Currents

The antenna current flowing on the line as a result of voltage induced from the antenna will be small if the overall circuit, considering the line simply as a single conductor, is not resonant at the operating frequency. The frequency (or frequencies) at which the system is resonant depends on the total length and whether the transmission line is grounded or not at the transmitter end.

If the line is connected to a coupling circuit that is not grounded, either directly or through a capacitance of more than a few picofarads, it is necessary to consider only the length of the antenna and line. In the end-fed arrangement, shown at A in Fig. 3-52, the line length,  $L$ , should not be an integral multiple or close to such a multiple of a half wavelength. In the center-fed system, Fig. 3-52B, the length of the line plus *one side* of the antenna should not be a multiple of a half wavelength. In this case the two halves of the antenna are simply in parallel so far as resonance for the induced "antenna" current on the line is concerned, because the line conductors themselves act in parallel. When the antenna is to be used in several bands, resonance of this type should be avoided at all frequencies to be used. Fig. 3-53 shows, as solid lines along the length scale, the lengths that avoid exact resonance on frequencies from 3.5 to 29.7 MHz. These are based on the usual antenna-length formulas; the velocity factor of the line plays no part in establishing such resonances since it applies only to true transmission-line currents.

Whenever possible, it is best to choose line lengths, such as those indicated by the arrows, that fall midway in the nonresonant range. This is

because the resonances are not extremely sharp. Working close to resonance, although not exactly on it, will allow an appreciable "antenna" current to flow even though it may not be as large as it would if the line were exactly resonant for it. For the same reason the line length should be chosen to fall in a range where there is a considerable distance between resonances. A length of 76 feet, for example, would be definitely less susceptible to resonance effects than a length of 96 feet.

The lengths shown in Fig. 3-53 are subject to some modification in practice. Transmission lines usually have bends, are at varying heights above ground, etc., all of which will modify the resonant frequency. It is advisable to check the system for resonance at and near all operating frequencies before assuming that the line is safely detuned for antenna currents. This can be done by temporarily connecting the ends of the line together and coupling them through a small capacitance (not more than a few pF) to a resonance indicator such as a grid-dip meter. Very short leads should be used between the meter and antenna. Fig. 3-54 shows the method. Once the resonance points are known it is a simple matter to prune the feeders to get as far away as possible from resonance at any frequency to be used.

Resonances in systems in which the coupling apparatus is grounded at the transmitter are not so easily predicted. The "ground" in such a case is usually the metal chassis of the transmitter itself, not actual ground. In the average amateur station it is not possible to get a connection to real ground without having a lead that is an appreciable fraction of wavelength long. At the higher frequencies, and particularly in the vhf region, the distance from the transmitter to ground may be one wavelength or more. Probably the best plan in such cases is to make the length  $L$  in Fig. 3-52 equal to a multiple of a half wavelength. If the transmitter has fairly large capacitance to ground, a system of this length will be effectively detuned for the fundamental and all even harmonics when grounded to the transmitter at the coupling apparatus. However, the resonance frequencies will depend on the arrangement and constants of the coupling

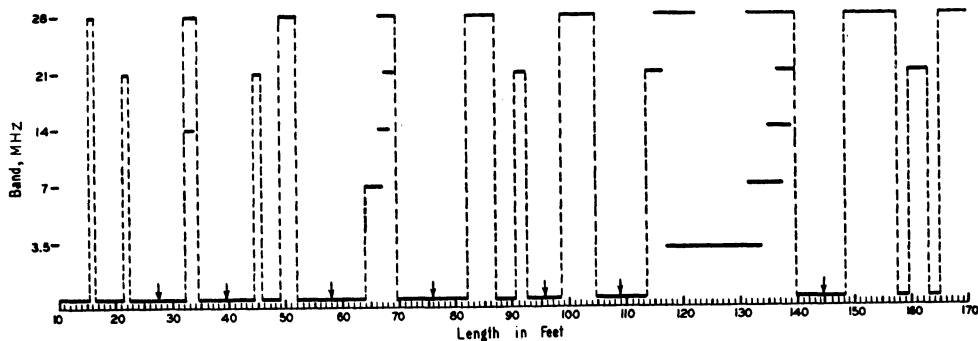

Fig. 3-53 — Lengths shown by solid lines along the horizontal axis avoid exact resonance at frequencies in all amateur bands from 3.5 to 29.7 MHz, in systems where the coupling apparatus is not grounded. Best operating lengths are at the centers of the wider ranges, as shown by the arrows. These lengths correspond to  $L$  in Fig. 3-52.

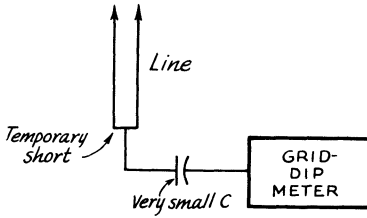

Fig. 3-54 — Using a grid-dip meter to check resonance of the antenna system for antenna currents on the transmission line. The small capacitance may be a short length of wire connected to the feed line, coupled lightly to the grid-dip-oscillator coil with a 1-turn loop.

system even in such a case, and preferably should be checked by means of the grid-dip meter. If this test shows resonance at or near the operating frequency, alternative grounds (to a heating radiator, for example) should be tried until a combination is found that detunes the whole system.

It should be quite clear, from the mechanism that produces antenna currents on a transmission line, that such currents are entirely independent of the normal operation as a true transmission line. It does not matter whether the line is perfectly matched or is operated with a high standing-wave ratio. Nor does it matter what kind of line is used, air-insulated or solid-dielectric, parallel-conductor or coax. In every case, the antenna currents should be minimized by detuning the line if the line is to fulfill only its primary purpose of transferring power to the antenna.

#### Other Causes of Unbalance

Unbalance in center-fed systems can arise even when the line is brought away at right angles to the antenna for a considerable distance. If both halves of the antenna are not symmetrically placed with respect to nearby conductors (such as power and telephone wires, downspouting, etc.) the antenna itself becomes unbalanced and the current distribution is different in the two halves. Because of this unbalance a voltage will be induced in the line even if the line is symmetrical with respect to the antenna.

### MATCHED LINES

Operating the transmission line at a low standing-wave ratio requires that the line be terminated, at its output end, in a resistive load matching the characteristic impedance of the line as closely as possible. The problem can be approached from two standpoints: (1) selecting a transmission line having a characteristic impedance that matches the antenna resistance at the point of connection; or (2) transforming the antenna resistance to a value that matches the  $Z_0$  of the line selected.

The first approach is simple and direct, but its application is limited because the antenna impedance and line impedance are alike only in a few special cases. The second approach provides a good

deal of freedom in that the antenna and line can be selected independently. Its disadvantage is that it is more complicated constructionally. Also, it sometimes calls for a somewhat tedious routine of measurement and adjustment before the desired match is achieved.

#### Operating Considerations

As pointed out earlier in this chapter, most antenna systems show a marked change in resistance when going from the fundamental to multiples of the fundamental frequency. For this reason it is usually possible to match the line impedance only on one frequency. A matched antenna system is consequently a one-band affair, in most cases. It can, however, usually be operated over a fair frequency range in a given band. The frequency range over which the standing-wave ratio is low is determined by the impedance-vs.-frequency characteristic of the antenna. If the change in impedance is small for a given change in frequency, the SWR will be low over a fairly wide band of frequencies. However, if the impedance change is rapid (a sharply resonant or high- $Q$  antenna — see discussion of  $Q$  later in this chapter) the SWR will also rise rapidly as the operating frequency is shifted to one side or the other of the frequency for which the antenna is resonant and for which the line is matched.

#### Antenna Resonance

A point that needs emphasis in connection with matching the antenna to the line is that, with the exception of a few special cases discussed later in this chapter, the impedance at the point where the line is connected must be a *pure resistance*. This means that the antenna system must be resonant at the frequency for which the line is to be matched. (Some types of long-wire antennas are exceptions, in that their input impedances are resistive over a wide band of frequencies. Such systems are essentially nonresonant.) The higher the  $Q$  of the antenna system, the more essential it is that exact resonance be established before an attempt is made to match the line. This is particularly true of close-spaced parasitic arrays. With simple dipole and harmonic antennas, the tuning is not so critical and it is usually sufficient to cut the antenna to the

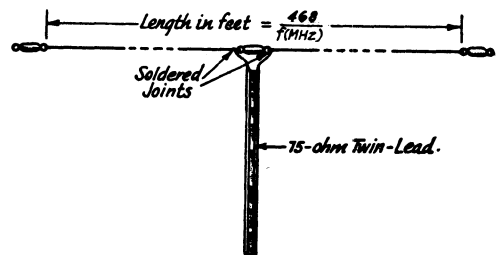

Fig. 3-55 — Half-wave dipole fed with 75-ohm Twin-Lead, giving a close match between antenna and line impedance. The leads in the "Y" from the end of the line to the ends of the center insulator should be as short as possible.



length given by the appropriate formula in Chapter Two. The frequency should be selected to be at the center of the range of frequencies (which may be the entire width of an amateur band) over which the antenna is to be used.

### DIRECT MATCHING

As discussed in Chapter Two, the impedance at the center of a resonant half-wave antenna at heights of the order of  $1/4$  wavelength and more is resistive and is in the neighborhood of 70 ohms. This is fairly well matched by transmitting-type Twin-Lead having a characteristic impedance of 75 ohms. It is possible, therefore, to operate with a low SWR using the arrangement shown in Fig. 3-55. No precautions are necessary beyond those already described in connection with antenna-to-line coupling.

This system is badly mismatched on *even* multiples of the fundamental frequency, since the feed in such cases is at a high-impedance point. However, it is reasonably well matched at *odd* multiples of the fundamental. For example, an antenna resonant near the low-frequency end of the 7-MHz band will operate with a low SWR over the 21-MHz band (three times the fundamental).

The same method may be used to feed a harmonic antenna at any current loop along the wire. For lengths up to three or four wavelengths the SWR should not exceed 2 to 1 if the antenna is  $1/4$  or  $1/2$  wavelength above ground.

At the fundamental frequency the SWR should not exceed about 2 to 1 within a frequency range  $\pm 2\%$  from the frequency of exact resonance. Such a variation corresponds approximately to the entire width of the 7-MHz band, if the antenna is resonant at the center of the band. A wire antenna is assumed. Antennas having a greater ratio of diameter to length will have a lower change in SWR with frequency.

#### Coaxial Cable

Instead of using Twin-Lead as just described, the center of a half-wave dipole may be fed through 75-ohm coaxial cable such as RG-11/U, as shown in Fig. 3-56. Cable having an impedance of approximately 50 ohms, such as RG-8/U, also may be used, particularly in those cases where the antenna height is such as to lower the radiation resistance of the antenna, below  $1/4$  wavelength. (See Chapter Two.) The principle is exactly the same as with Twin-Lead, and the same remarks as to SWR apply. However, there is a considerable practical difference between the two types of line. With the parallel-conductor line the system is symmetrical, but with coaxial line it is inherently unbalanced.

Stated broadly, the unbalance with coaxial line is caused by the fact that the outside of the outer conductor is not coupled to the antenna in the same way as the inner conductor and the inside of the outer conductor. The overall result is that current will flow on the outside of the outer conductor in the simple arrangement shown in Fig. 3-56. The unbalance is rather small if the line diameter is very small compared with the length of

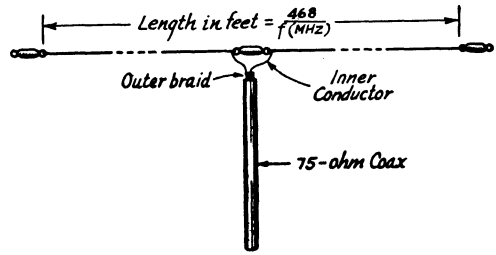

Fig. 3-56 — Half-wave antenna fed with 75-ohm coaxial cable. The outside of the outer conductor of the line may be grounded for lightning protection.

the antenna, a condition that is met fairly well at the lower amateur frequencies. However, it is not negligible in the vhf and uhf range, nor should it be ignored at 28 MHz. The current that flows on the outside of the line because of this unbalance, it should be noted, does not arise from the same type of coupling as the “antenna” current previously discussed. The coupling pictured in Fig. 3-51 can still occur, *in addition*. However, the remedy is the same in both cases — the system must be detuned for currents on the outside of the line. This can be done by choosing one of the recommended lengths in Fig. 3-53, or by an actual resonance check using the method shown in Fig. 3-54.

#### Balancing Devices

The unbalanced coupling described in the preceding paragraph can be nullified by the use of devices that prevent the unwanted current from flowing on the outside of the coaxial line. This may be done either by making the current cancel itself out or by choking it off. Devices of this type fall in a class of circuits usually termed *baluns*, a contraction for “balanced to unbalanced.” The baluns described in an earlier section under “Coupling the Transmitter to the Line” perform the same function, but the techniques described here are generally more suitable for mechanical reasons in coupling the line to the antenna.

The voltages at the antenna terminals in Fig. 3-56 are equal in amplitude with respect to ground but opposite in phase. Both these voltages act to cause a current to flow on the outside of the coax, and if the currents produced by both voltages were equal, the resultant current on the outside of the line would be zero since the currents are out of phase and would cancel each other. But since one antenna terminal is directly connected to the cable shield while the other is only weakly coupled to it, the voltage at the directly connected terminal produces a much larger current, and so there is relatively little cancellation.

The two currents could be made equal in amplitude by making a direct connection between the outside of the line and the antenna terminal that is connected to the inner conductor, but if it were done right at the antenna terminals the line and antenna would be short-circuited. However, if the connection is made through a conductor

parallel to the line and a quarter wavelength long, as shown in Fig. 3-57A, the second conductor and the outside of the line act as a quarter-wave "insulator" for the normal voltage and current at the antenna terminals. (This is because a quarter-wave line short-circuited at the far end exhibits a very high resistive impedance, as explained earlier in this chapter.) On the other hand, any unbalance current flowing on the outside of the line because of the direct connection between it and the antenna has a counterpart in an equal current flowing on the second conductor, because the latter is directly connected to the *other* antenna terminal. Where the two conductors are joined together at the bottom, the resultant of the two currents is zero, since they are of opposite phase. Thus, no current flows on the remainder of the transmission line.

Note that the length of the extra conductor has no particular bearing on its operation in balancing out the undesired current. The length is critical only in respect to preventing the normal operation of the antenna from being upset.

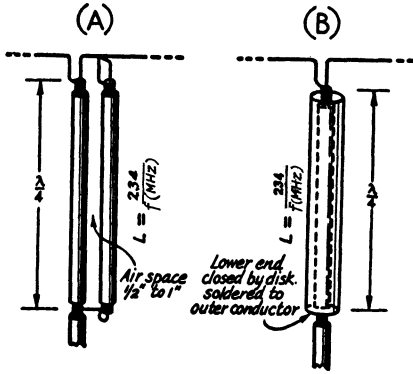

Fig. 3-57 — Methods of balancing the termination when a coaxial cable is connected to a balanced antenna.

**Combined Balun and Matching Stub**

In certain antenna systems the balun length can be considerably shorter than a quarter wavelength; the balun is, in fact, used as part of the matching system. This requires that the radiation resistance be fairly low as compared with the line  $Z_0$  so that a match can be brought about by first shortening the antenna to make it have a capacitive reactance, and then using a shunt inductance across the antenna terminals to resonate the antenna and simultaneously raise the impedance to a value equal to the line  $Z_0$ . (See later section on matching stubs.) The balun is then made the proper length to exhibit the desired value of inductive reactance.

The basic matching method is shown at A in Fig. 3-58, and the balun adaptation to coaxial feed is shown at B. The matching stub in the latter case is a parallel-line section, one conductor of which is the outside of the coax between point X and the antenna; the other stub conductor is an equal

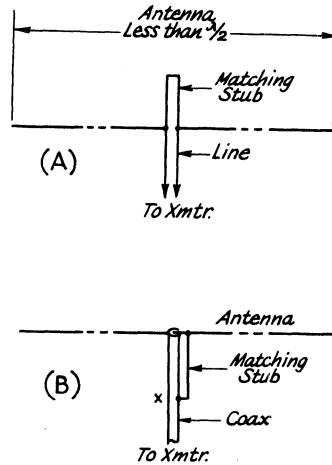

Fig. 3-58 — Combined matching stub and balun. A — Basic arrangement; B — Balun arrangement achieved by using a section of the outside of the coax feed line as one conductor of a matching stub.

length of wire. (A piece of coax may be used instead, as in the balun in Fig. 3-57A.) The spacing between the stub conductors can be two to three inches. The stub of Fig. 3-58 is ordinarily much shorter than a quarter wavelength, and the impedance match can be adjusted by adjusting the stub length along with the antenna length. With simple coax feed, even with a quarter-wave balun as in Fig. 3-57, the match depends entirely on the actual antenna impedance and the  $Z_0$  of the cable; no adjustment is possible.

**Adjustment**

When a quarter-wave balun is used it is advisable to resonate it before connecting the antenna. This can be done without much difficulty if a grid-dip meter is available. In the system shown in Fig. 3-57A, the section formed by the two parallel pieces of line should first be made slightly longer than the length given by the formula. The shorting connection at the bottom may be installed permanently. With the grid-dip meter coupled to the shorted end, check the frequency and cut off small lengths of the shield braid (cutting both lines equally) at the open ends until the stub is resonant at the desired frequency. In each case leave just enough inner conductor remaining to make a short connection to the antenna. After resonance has been established, solder the inner and outer conductors of the second piece of coax together and complete the connections indicated in Fig. 3-57A.

An alternative method is first to adjust the antenna length to the desired frequency, with the line and stub disconnected, then connect the balun and recheck the frequency. Its length may then be adjusted so that the overall system is again resonant at the desired frequency.

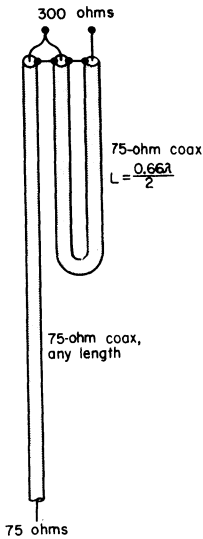

Fig. 3-59 — A balun which provides an impedance step-up ratio of 4:1.

### Construction

In constructing a balun of the type shown in Fig. 3-57A, the additional conductor and the line should be maintained parallel by suitable spacers. It is convenient to use a piece of coax for the second conductor; the inner conductor can simply be soldered to the outer conductor at both ends since it does not enter into the operation of the device. The two cables should be separated sufficiently so that the vinyl covering represents only a small proportion of the dielectric between them. Since the principal dielectric is air, the length of the quarter-wave section is based on a velocity factor of 0.95, approximately.

### Detuning Sleeves

The detuning sleeve shown in Fig. 3-57B also is essentially an air-insulated quarter-wave line, but of the coaxial type, with the sleeve constituting the outer conductor and the outside of the coax line being the inner conductor. Because the impedance at the open end is very high, the unbalanced voltage on the coax line cannot cause much current to flow on the outside of the sleeve. Thus the sleeve acts like a choke coil in isolating the remainder of the line from the antenna. (The same viewpoint can be used in explaining the action of the quarter-wave arrangement shown at A, but is less easy to understand in the case of baluns less than  $1/4$  wavelength long.)

A sleeve of this type may be resonated by cutting a small longitudinal slot near the bottom, just large enough to take a single-turn loop which is, in turn, link-coupled to the grid-dip meter. If the sleeve is a little long to start with, a bit at a time can be cut off the top until the stub is resonant.

The diameter of the coaxial detuning sleeve in B should be fairly large compared with the diameter of the cable it surrounds. A diameter of two inches or so is satisfactory with half-inch cable. The sleeve should be symmetrically placed with respect to the center of the antenna so that it will be equally coupled to both sides. Otherwise a current will be induced from the antenna to the outside of the sleeve. This is particularly important at vhf and uhf.

In both the balancing methods shown in Fig. 3-57 the quarter-wave section should be cut to be resonant at exactly the same frequency as the antenna itself. These sections tend to have a beneficial effect on the impedance-frequency characteristic of the system, because their reactance varies in the opposite direction to that of the antenna. For instance, if the operating frequency is slightly below resonance the antenna has capacitive reactance, but the shorted quarter-wave sections or stubs have inductive reactance. Thus the reactances tend to cancel, which prevents the impedance from changing rapidly and helps maintain a low standing-wave ratio on the line over a band of frequencies.

### Impedance Step-up Balun

A coax-line balun may also be constructed to give an impedance step-up ratio of 4:1. This form of balun is shown in Fig. 3-59. If 75-ohm line is used, as indicated, the balun will provide a match for a 300-ohm terminating impedance. The U-shaped section of line must be an electrical half wave in length, taking the velocity factor of the line into account. In most installations using this type of balun, it is customary to roll up the length of line represented by the U-shaped section into a coil of several inches in diameter. The coil turns may be bound together with electrical tape. Because of the bulk and weight of the balun, this type is seldom used with wire-line antennas suspended by insulators at the antenna ends. More commonly it is used with multielement antennas, where its weight may be supported by the boom of the antenna system.

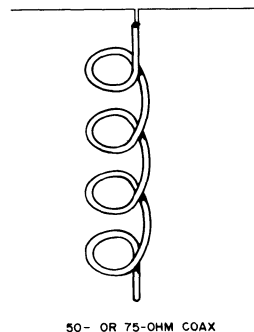

Fig. 3-60 — An rf choke formed by coiling the feed line at the point of connection to the antenna.

### Coax-Line RF Choke

As was discussed earlier in this section, the unbalanced coupling which results from connecting coaxial line to a balanced antenna may be nullified by choking off the current from flowing on the outside of the feed line. A direct approach to this objective is shown in Fig. 3-60, where the line itself is formed into a coil at the antenna feed point. Ten turns of coax line coiled at a diameter of 6 inches has been found effective for the hf bands. The turns may be secured in a tight coil with electrical tape. This approach offers the advantage of requiring no pruning adjustments. The effectiveness of a choke of this sort decreases at the higher frequencies, however, because of the distributed capacitance among the turns.

### QUARTER-WAVE TRANSFORMERS

The impedance-transforming properties of a quarter-wave transmission line can be used to good advantage in matching the antenna impedance to the characteristic impedance of the line. As described earlier, the input impedance of a quarter-wave line terminated in a resistive impedance  $Z_R$  is

$$Z_S = \frac{Z_0^2}{Z_R}$$

Rearranging this equation gives

$$Z_0 = \sqrt{Z_R Z_S}$$

This means that any value of load impedance  $Z_R$  can be transformed into any desired value of impedance  $Z_S$  at the input terminals of a quarter-wave line, provided the line can be constructed to have a characteristic impedance  $Z_0$  equal to the square root of the product of the two impedances. The factor that limits the range of impedances that can be matched by this method is the range of values for  $Z_0$  that is physically realizable. The latter range is approximately 50 to 600 ohms.

Practically any type of line can be used for the matching section, including both air-insulated and

solid-dielectric lines. Such a matching arrangement is popularly known as the "Q" matching system.

One application of this type of matching section is in matching a half-wave antenna to a 600-ohm line, as shown in Fig. 3-61. Assuming that the antenna has a resistive impedance in the vicinity of 65 to 70 ohms, the required  $Z_0$  of the matching section is approximately 200 ohms. A section of this type can be constructed of parallel tubing, from the data in Fig. 3-30.

The 1/4-wave transformer may be adjusted to resonance before being connected to the antenna by short-circuiting one end and coupling it inductively at that end to a grid-dip meter. The length of the short-circuiting conductor lowers the frequency slightly, but this can be compensated for by adding half the length of the shorting bar to each conductor after resonating, measuring the shorting-bar length between the centers of the conductors.

### Driven Beam Elements

Another application for the quarter-wave "linear transformer" is in matching the very low antenna impedances encountered in close-spaced directional arrays to a transmission line having a characteristic impedance of 300 to 600 ohms. The observed impedances at the antenna feed point in such cases range from about 8 to 20 ohms. A matching section having a  $Z_0$  of 75 ohms is useful with such arrays. The impedance at its input terminals will vary from approximately 700 ohms with an 8-ohm load to 280 ohms with a 20-ohm load.

Transmitting Twin-Lead is suitable for this application; such a short length is required that the loss in the matching section should not exceed about 0.6 dB even though the SWR in the matching section may be almost 10 to 1 in the extreme case.

### DELTA MATCHING

Among the properties of a coil-and-capacitor resonant circuit is that of transforming impedances. If a resistive impedance,  $Z_1$  in Fig. 3-62, is connected across the outer terminals  $AB$  of a resonant  $LC$  circuit, the impedance  $Z_2$  as viewed looking into another pair of terminals such as  $BC$  will also be resistive, but will have a different value depending on the mutual coupling between the parts of the coil associated with each pair of terminals.  $Z_2$  will be less than  $Z_1$  in the circuit shown. Of course this relationship will be reversed if  $Z_1$  is connected across terminals  $BC$  and  $Z_2$  is viewed from terminals  $AB$ .

A resonant antenna has properties similar to those of a tuned circuit. The impedance presented between any two points symmetrically placed with respect to the center of a half-wave antenna will depend on the distance between the points. The greater the separation, the higher the value of impedance, up to the limiting value that exists between the open ends of the antenna. This is also suggested in Fig. 3-62. The impedance  $Z_A$  between terminals 1 and 2 is lower than the impedance  $Z_B$

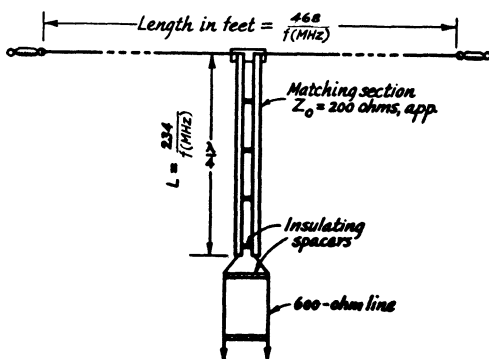

Fig. 3-61 — Matching a half-wave antenna to a 600-ohm line through a quarter-wave linear transformer. This arrangement is popularly known as the "Q" matching system.

## Transmission Lines

between terminals 3 and 4. Both impedances, however, are purely resistive if the antenna is resonant.

This principle is utilized in the delta matching system shown in Fig. 3-63. The center impedance of a half-wave dipole is too low to be matched directly by any practicable type of air-insulated parallel-conductor line. However, it is possible to find, between two points, a value of impedance that can be matched to such a line when a "fanned" section or delta is used to couple the line and antenna. The antenna length,  $L$ , should be based on the formula in Chapter Two, using the appropriate factor for the length/diameter ratio. The ends of the delta or "Y" should be attached at points equidistant from the center of the antenna. When so connected, the terminating impedance for the line will be essentially purely resistive.

Based on experimental data for the case of a simple half-wave antenna coupled to a 600-ohm line, the total distance,  $A$ , between the ends of the delta should be  $0.120\lambda$  for frequencies below 30 MHz, and  $0.115\lambda$  for frequencies above 30 MHz. The length of the delta, distance  $B$ , should be  $0.150\lambda$ . These values are based on a wavelength in air, and on the assumption that the center impedance of the antenna is approximately 70 ohms. The dimensions will require modification if the actual impedance is very much different.

The delta match can be used for matching the driven element of a directive array to a transmission line, but if the impedance of the element is low — as is frequently the case — the proper dimensions for  $A$  and  $B$  must be found by experimentation.

The delta match is somewhat awkward to adjust when the proper dimensions are unknown, because both the length and width of the delta must be varied. An additional disadvantage is that there is always some radiation from the delta. This is because the conductors are not close enough together to meet the requirement (for negligible radiation) that the spacing should be very small in comparison with the wavelength.

## FOLDED DIPOLES

Basic information on the folded dipole antenna appears in Chapter Two. The two-wire system in Fig. 2-86 is an especially useful one because the input impedance is so close to 300 ohms that it can be fed directly with 300-ohm Twin-Lead or with open line without any other matching arrangement, and the line will operate with a low standing-wave ratio. The antenna itself can be built like an open-wire line; that is, the two conductors can be held apart by regular feeder spreaders. TV "ladder" line is quite suitable. It is also possible to use 300-ohm line for the antenna, in addition to using it for the transmission line. Additional construction information is contained in Chapter Thirteen. Since the antenna section does not operate as a transmission line, but simply as two wires in parallel, the velocity factor of Twin-Lead can be ignored in computing the antenna length. The reactance of the folded-dipole antenna varies

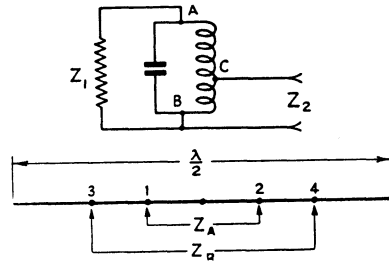

Fig. 3-62 — Impedance transformation with a resonant circuit, together with antenna analogy.

less rapidly with frequency changes away from resonance than a single-wire antenna. Therefore it is possible to operate over a wide band of frequencies, while maintaining a low SWR on the line, than with a simple dipole. This is partly explained by the fact that the two conductors in parallel form a single conductor of greater effective diameter.

For reasons described in Chapter Two, a folded dipole will not accept power at twice the fundamental frequency. However, the current distribution is correct for harmonic operation on odd multiples of the fundamental. Because the radiation resistance is not greatly different for a three-half-wave antenna and a single half wave, a folded dipole can be operated on its third harmonic with a low SWR in a 300-ohm line. A 7-MHz folded dipole, consequently, can be used for the 21-MHz band as well.

### Length Adjustment of Multi- and Unequal-Conductor Dipoles

Figs. 2-87 and 2-88 of Chapter Two show how a wide range of impedance step-up ratios is available by varying the size of the conductors and/or by using more than two. Because the relatively large effective thickness of the antenna reduces the rate of change of reactance with frequency, the tuning becomes relatively broad. It is a good idea, however, to check the resonant frequency with a grid-dip meter in making length adjustments. The transmission line should be disconnected and the antenna terminals temporarily short-circuited when this check is being made.

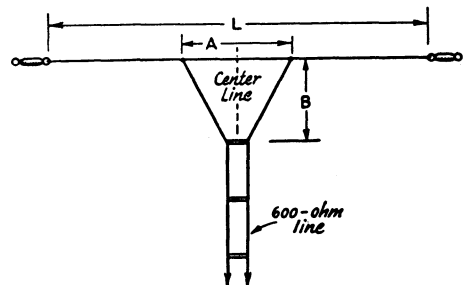

Fig. 3-63 — The "delta" matching system.

As shown by the charts of Figs. 2-87 and 2-88, there are two special cases where the impedance ratio of the folded dipole is independent of the spacing between conductors. These are for a ratio of 4:1 with the two-conductor dipole and a ratio of 9:1 in the three-conductor case. In all other cases, the impedance ratio can be varied by adjustment of the spacing. The adjustment range is quite limited when ratios near 4 and 9, respectively, are used, but increases with the departure in either direction from these "fixed" values. This offers a means for final adjustment of the match to the transmission line when the antenna resistance is known approximately but not exactly.

If a suitable match cannot be obtained by adjustment of spacing, there is no alternative but to change the ratio of conductor diameters. The impedance ratio decreases with an increase in spacing, and vice versa. Hence, if a match cannot be brought about by changing the spacing, such a change will at least indicate whether the ratio of  $d_2/d_1$  should be increased or decreased.

### THE T AND GAMMA

The "T" matching system shown in Fig. 3-64 has a considerable resemblance to the folded dipole; in fact, if the distance  $A$  is extended to the full length of the antenna the system becomes an ordinary folded dipole. The T has considerable flexibility in impedance ratio and is more convenient, constructionally, than the folded dipole when used with the driven element of a rotatable parasitic array. Since it is a symmetrical system it is inherently balanced, and so is well suited to use with parallel-conductor transmission lines. If coaxial line is used, some form of balun, as described earlier, should be installed. Alternatively, the gamma form described below can be used with unbalanced lines.

The current flowing at the input terminals of the T consists of the normal antenna current divided between the radiator and the T conductors in a way that depends on their relative diameters and the spacing between them, with a superimposed transmission-line current flowing in each half of the T and its associated section of the antenna. Each such T conductor and the associated antenna conductor can be looked upon as a section of transmission line shorted at the end. Since it is shorter than  $1/4$  wavelength it has inductive

reactance; as a consequence, if the antenna itself is exactly resonant at the operating frequency, the input impedance of the T will show inductive reactance as well as resistance. The reactance must be tuned out if a good match to the transmission line is to be secured. This can be done either by shortening the antenna to obtain a value of capacitive reactance that will reflect through the matching system to cancel the inductive reactance at the input terminals, or by inserting a capacitance of the proper value in series at the input terminals as shown in Fig. 3-65, upper drawing.

A theoretical analysis has shown that the part of the impedance step-up arising from the spacing and ratio of conductor diameters is approximately the same as given for the folded dipole in Fig. 2-87. The actual impedance ratio is, however, considerably modified by the length  $A$  of the matching section (Fig. 3-64). The trends can be stated as follows:

- 1) The input impedance increases as the distance  $A$  is made larger, but not indefinitely. There is in general a distance  $A$  that will give a maximum value of input impedance, after which further increase in  $A$  will cause the impedance to decrease.
- 2) The distance  $A$  at which the input impedance reaches a maximum is smaller as  $d_2/d_1$  (using the notation of Fig. 2-87) is made larger, and becomes smaller as the spacing between the conductors is increased.
- 3) The maximum impedance values occur in the region where  $A$  is 40 to 60 percent of the antenna length in the average case.
- 4) Higher values of input impedance can be realized when the antenna is shortened to cancel the inductive reactance of the matching section.

### Simple Dipole Matching

For a dipole having an approximate impedance of 70 ohms, the T matching-section dimensions for matching a 600-ohm line are given by the following formulas:

$$A \text{ (feet)} = \frac{180.5}{f(\text{MHz})}$$

$$B \text{ (inches)} = \frac{114}{f(\text{MHz})}$$

These formulas apply for wire antennas with the matching section made of the same size wire. With an antenna element of different impedance, or for matching a line having a  $Z_0$  other than 600 ohms, the matching-section dimensions can be determined experimentally.

### The Gamma

The gamma arrangement shown in Fig. 3-66 is an unbalanced version of the T, suitable for use with coaxial lines. Except for the fact that the matching section is connected between the center and one side of the antenna, the remarks above about the behavior of the T apply equally well. The inherent reactance of the matching section can be canceled either by shortening the antenna appropriately or by using the resonant length and

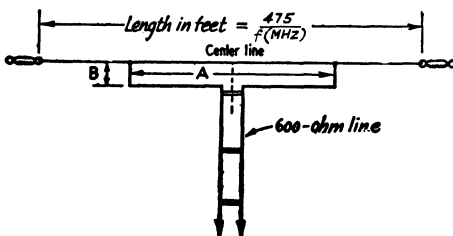

Fig. 3-64 — The T matching system, applied to a half-wave antenna and 600-ohm line.

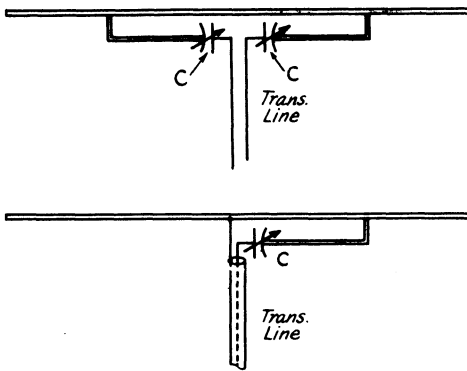

Fig. 3-65 — Series capacitors for tuning out residual reactance with the T and gamma matching systems. A maximum capacitance of 150 pF in each capacitor should provide sufficient adjustment range, in the average case, for 14-MHz operation. Proportionately smaller capacitance values can be used on higher frequency bands. Receiving-type plate spacing will be satisfactory for power levels up to a few hundred watts.

installing a capacitor  $C$ , as shown in the lower drawing of Fig. 3-65.

The gamma match has been widely used for matching coaxial cable to all-metal parasitic beams for a number of years. Because it is well suited to “plumber’s delight” construction, where all the metal parts are electrically and mechanically connected, it has become quite popular for amateur arrays.

Because of the many variable factors — driven-element length, gamma rod length, rod diameter, spacing between rod and driven element, and value of series capacitor — there are a number of combinations which will provide the desired match. However, the task of finding a proper combination can be a tedious one, as the settings are interrelated. A few “rules of thumb” have evolved which provide a starting point for the various factors. For matching a multielement array made of aluminum tubing to 52-ohm line, the length of the rod should be  $0.04$  to  $0.05 \lambda$ , its diameter  $1/3$  to  $1/2$  that of the driven element, and its spacing (center to center from the driven element), approximately  $0.007 \lambda$ . The capacitance value should be approximately 7 pF per meter of wavelength, i.e., about 140 pF for 20-meter operation. The exact gamma dimensions and value for the capacitor will depend upon the radiation resistance of the driven element, and whether or not it is resonant. These starting-point dimensions are for an array having a feed-point impedance of about 25 ohms, with the driven element shortened approximately 3% from resonance.

#### Calculating Gamma Dimensions

D. J. Healey, W3PG, has developed a method of determining by calculations whether or not a particular set of parameters for a gamma match will be suitable for obtaining the desired impe-

dance transformation. (See bibliography at the end of this chapter.) The procedure uses mathematical equations and the Smith Chart (see earlier section of this chapter), and consists of the following basic steps.

1) Find the impedance step-up ratio for the gamma rod and element diameters and spacing. (See Fig. 2-87; use the rod diameter as  $d_1$  and the element diameter as  $d_2$ .)

2) Determine the  $Z_0$  of the “transmission line” formed by the gamma rod and the element, considering them as two parallel conductors. Use the equation

$$Z_0 = 276 \log_{10} \frac{2S}{\sqrt{d_1 d_2}} \text{ ohms}$$

where the terms are the same as for Fig. 2-87.

3) Assign (or assume) a length for the gamma rod, expressed in electrical degrees. Call this angle  $\theta$ .

4) Determine the increased impedance of the driven element over its center-point impedance, caused by its being fed off center. Use the equation

$$Z_2 = \frac{Z_1}{\cos^2 \theta}$$

where  $Z_2$  is the impedance at the tap point and  $Z_1$  is the complex impedance at the center of the element.

5) Determine the “load” impedance at the antenna end of the gamma “transmission line.” This is the resultant value of Step 1 above multiplied by the value for  $Z_2$ , taken as  $R + jX$  from Step 4. Normalize this impedance value to the  $Z_0$  of the gamma “transmission line” determined in Step 2. Plot this normalized impedance on the Smith Chart.

6) Using the TOWARD GENERATOR wavelengths scale of the Smith Chart, take the “transmission line” length (rod length) into account and determine the normalized input impedance to this line. This impedance represents the portion of the total impedance at the gamma feed point which arises from the antenna alone.

7) In shunt with the impedance from Step 6 is an inductive reactance caused by the short-circuit termination on the gamma “transmission line” itself. Determine the normalized value of this inductance either from the Smith Chart (taking  $0 + j0$  as the load and the rod length into account on the TOWARD GENERATOR wavelengths scale) or from the equation

$$X_p = j \tan \theta \text{ ohms}$$

Also, Fig. 3-72 may be used.

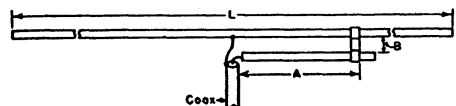

Fig. 3-66 — The gamma match, as used with tubing elements. The transmission line may be either 52-ohm or 75-ohm coax.

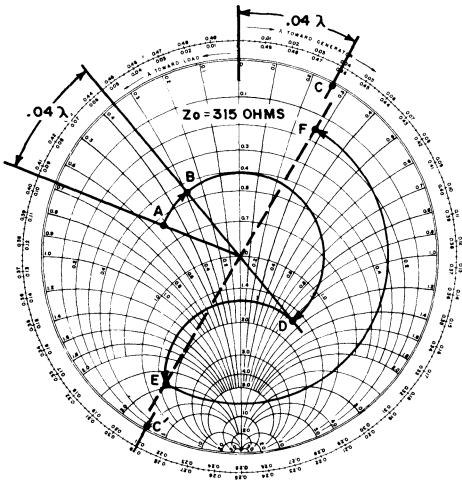

Fig. 3-67 — Smith Chart calculation of gamma dimensions. See text.

8) Invert the line input impedance (from Step 6) to obtain the equivalent admittance,  $G + jB$ . This may be done by locating the point on the Chart which is diametrically opposite that for the plot of the impedance. (Remember that inductance is considered to be a negative susceptance, and capacitance a positive susceptance.) Similarly, invert the inductance value from Step 7. (This susceptance will simply be the reciprocal of the reactance.)

9) Add the two parallel susceptance components from Step 8, taking algebraic signs into account. Plot the new admittance on the Smith Chart,  $G$  (from Step 8) +  $jB$  (from this step).

10) Invert the admittance of Step 9 to impedance by locating the diametrically opposite point on the Smith Chart. Convert the normalized resistance and reactance components to ohms by multiplying each by the line  $Z_0$  (from Step 2). This impedance is that which terminates the transmission line with no gamma capacitor. A capacitor having the reactance of the  $X$  component of the impedance should be used to cancel the inductance, leaving a purely resistive line termination. If the dimensions were properly chosen, this value will be near the  $Z_0$  of the coaxial feed line.

As an example, assume a 20-meter Yagi beam is to be matched to 50-ohm line. The driven element is 1-1/2 inches in diameter, and the gamma rod is a length of 1/2-inch tubing, spaced 6 inches from the element (center to center). Initially, the rod length is adjusted to  $0.04 \lambda$ , or  $14.4^\circ$  (33 inches). The driven element has been shortened by 3% from its resonant length.

Following Step 1, from Fig. 2-87, the impedance step-up ratio is 6.4.

From the equation of Step 2, the  $Z_0$  of the transmission line is 315 ohms.

From Step 3,  $\theta = 14.4^\circ$ .

For Step 4, assume the antenna has a radiation resistance of 25 ohms and a capacitive reactance component of 25 ohms (about the reactance which would result from the 3% shortening). The overall impedance of the driven element is therefore  $25 - j25$  ohms. Using this value for  $Z_1$  in the equation of Step 4,  $Z_2$  is determined to be  $26.6 - j26.6$ .

In Step 5, the value obtained above for  $Z_2$ ,  $26.6 - j26.6$ , is multiplied by the step-up ratio (Step 1), 6.4. The resultant impedance is  $170 - j170$  ohms. Normalized to the  $Z_0$  of the gamma "transmission line," 315 ohms, this impedance is  $0.54 - j0.54$ . This value is plotted on the Smith Chart, shown at point A of Fig. 3-67.

Taking the line length into account ( $0.04 \lambda$ ) as directed in Step 6, the normalized line input impedance is found to be  $0.44 - j0.29$ , as shown at point B of Fig. 3-67.

From the equation in Step 7,  $X_p$  is found to be  $j0.257$ . This same value may be determined from the Smith Chart, as shown at point C, or from Fig. 3-72 for a matching-section length of  $14.4^\circ$ .

Point D is found on the Smith Chart as directed in Step 8, and represents a normalized admittance of  $1.6 + j1.07$  mhos. The inductance from Step 7, above, inverted to susceptance, is  $-j1/0.257 = -j3.89$ . (This same value may be read diametrically opposite point C in Fig. 3-67, at point C'.)

Proceeding as indicated in Step 9, the admittance components of the parallel combination are  $1.6 + j1.07 - j3.89 = 1.6 - j2.82$ . This admittance is plotted as shown at point E in Fig. 3-67.

Inverting the above admittance to its equivalent impedance, point F of Fig. 3-67, the normalized value of  $0.16 + j0.27$  is read. Multiplying each value by 315 (from Step 2), the input impedance to the gamma section is found to be  $50.4 + j85$  ohms.

Thus, a series capacitor having a reactance of 85 ohms is required to cancel the inductance in the gamma section (from the standard reactance equation the required capacitance is 134 pF), and a very good match is provided for 50-ohm line.

**Adjustment**

After installation of the antenna, the proper constants for the T and gamma must be determined experimentally. The use of the variable series capacitors, as shown in Fig. 3-65, is recommended for ease of adjustment. With a trial position of the tap or taps on the antenna, measure the SWR on the transmission line and adjust C (both capacitors simultaneously in the case of the

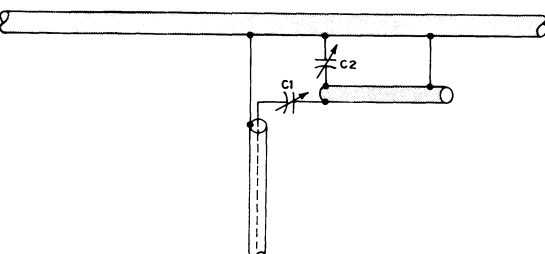

Fig. 3-68 — The omega match.



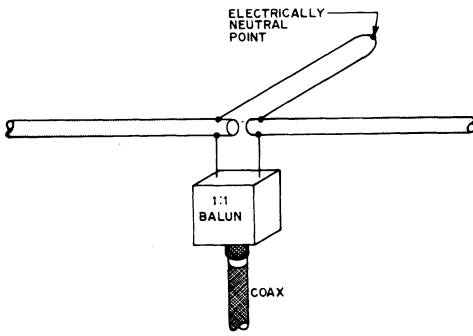

Fig. 3-69 — The hairpin match.

T) for minimum SWR. If it is not close to 1 to 1, try another tap position and repeat. It may be necessary to try another size of conductor for the matching section if satisfactory results cannot be secured. Changing the spacing will show which direction to go in this respect, just as in the case of the folded dipole discussed in the preceding section.

**THE OMEGA MATCH**

The omega match is a slightly modified form of the gamma match. In addition to the series capacitor, a shunt capacitor is used to aid in canceling a portion of the inductive reactance introduced by the gamma section. This is shown in Fig. 3-68. C1 is the usual series capacitor. The addition of C2 makes it possible to use a shorter gamma rod, or makes it easier to obtain the desired match when the driven element is resonant. (The effect of the shunt capacitor may be taken into account when calculating gamma dimensions, as in the foregoing section, during the performance of Step 9.) During adjustment, C2 will serve primarily to determine the resistive component of the load as seen by the coax line, and C1 serves to cancel any reactance.

**THE HAIRPIN AND BETA MATCHES**

The usual form of the hairpin match is shown in Fig. 3-69. Basically, the hairpin is a form of an L-matching network. Because it is somewhat easier to adjust for the desired terminating impedance than the gamma match, it is preferred by many amateurs. Its disadvantages, as compared to the gamma, are that it must be fed with a balanced line (a balun may be used with a coax feeder, as shown in Fig. 3-69), and the driven element must be split at the center. This latter requirement complicates the mechanical mounting arrangement for the element, by ruling out “plumber’s delight” construction.

As indicated in Fig. 3-69, the center point of the hairpin is electrically neutral. As such, it may be grounded or connected to the remainder of the antenna structure. The hairpin itself is usually secured by attaching this neutral point to the

boom of the antenna array. The beta match is electrically identical to the hairpin match, the difference being in the mechanical construction of the matching section. With the beta match, the conductors of the matching section straddle the boom, one conductor being located on either side, and the electrically neutral point consists of a sliding or adjustable shorting clamp placed around the boom and the two matching-section conductors.

The electrical operation of the hairpin match has been treated extensively by Gooch, Gardner, and Roberts (see bibliography at the end of this chapter). The antenna is matched to the transmission line by forming an equivalent parallel-resonant circuit in which the antenna resistance appears in series with the capacitance. The impedance of this type parallel-resonant circuit varies almost inversely with the series antenna resistance, and therefore can cause a very small antenna resistance to appear as a very large resistance at the terminals of the resonant circuit. The values of inductance and capacitance are chosen to transform the antenna resistance to a resistance value equal to the characteristic impedance of the transmission line.

The capacitive portion of this circuit is produced by slightly shortening the antenna driven element. For a given frequency the impedance of a shortened half-wave element appears as the

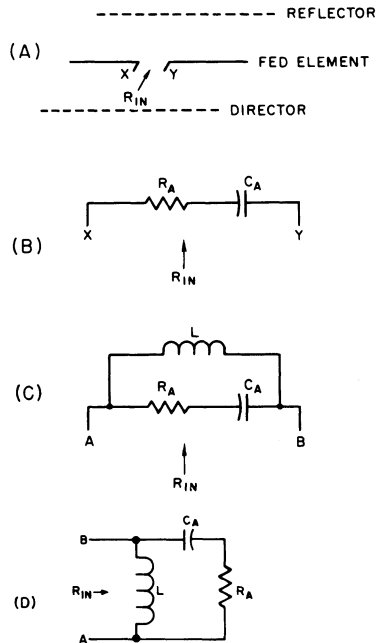

Fig. 3-70 — For the Yagi antenna shown at A, the input impedance at its operating frequency is represented at B, if the driven element is shorter than its resonant length. By adding an inductor, as shown at C, a low value of RA is made to appear as a higher impedance at terminals AB. At D, the diagram of C is redrawn in the usual L-network configuration.

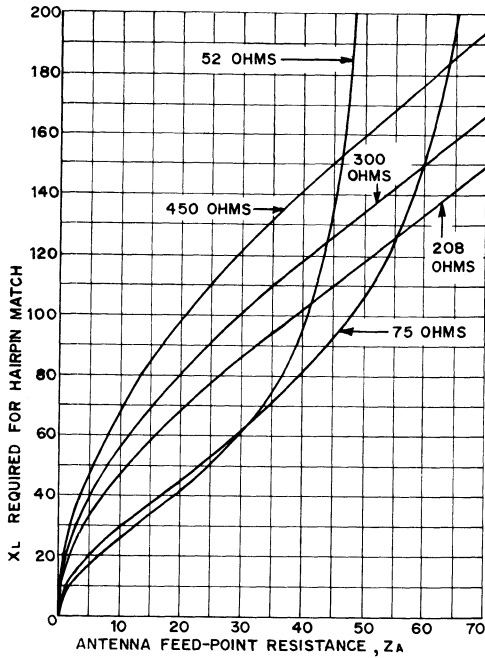

Fig. 3-71 — Reactance required to match various antenna resistances to common line or balun impedances.

antenna resistance and a capacitance in series, as indicated schematically in Fig. 3-70B. The inductive portion of the resonant circuit at C is a hairpin of heavy wire or small tubing which is connected across the driven-element center terminals. The diagram of C is redrawn in D to show the circuit in conventional *L*-network form.  $R_A$ , the radiation resistance, is a smaller value than  $R_{IN}$ , the impedance of the feed line. (In *L*-network matching, the higher of the two impedances to be matched is connected to the shunt-arm side of the network, and the lower impedance to the series-arm side.)

Instead of using a separate hairpin matching section and a balun, as shown in Fig. 3-69, a combined matching stub and balun may be used with coax line. This is shown in Fig. 3-58B. The principles of operation are discussed in a later section of this chapter titled *Stubs on Coaxial Lines*.

If the approximate radiation resistance of the antenna system is known, Figs. 3-71 and 3-72 may be used to gain an idea of the hairpin dimensions necessary for the desired match. The curves of Fig. 3-71 were obtained from design equations for *L*-network matching. Fig. 3-72 is based on the equation,  $X_p = j \tan \theta$ , which gives the inductive reactance as normalized to the  $Z_0$  of the hairpin, looking at it as a short-circuit-terminated length of transmission line. For example, if an antenna-system impedance of 20 ohms is to be matched to 52-ohm line, Fig. 3-71 indicates that the inductive reactance required for the hairpin is 41 ohms. If the hairpin is constructed of quarter-inch tubing

spaced 1-1/2 inches, its characteristic impedance is 300 ohms (from Fig. 3-30 or the equation associated with it). Normalizing the required 41-ohm reactance to this impedance,  $41/300 = 0.137$ . Entering the chart of Fig. 3-72 with this value, 0.137, on the scale at the bottom, it may be seen that the hairpin length should be 7.8 electrical degrees, or  $7.8/360$  wavelength. For purposes of these calculations, taking a 97.5% velocity factor into account, the wavelength in inches is  $11,500/f_{MHz}$ . If the antenna is to be used on 20 meters, the required hairpin length is  $\frac{7.8}{360} \times \frac{11,500}{14} = 17.8$  inches. The length of the hairpin affects primarily the resistive component of the terminating impedance as seen by the feed line. Greater resistances are obtained with longer hairpin sections, and smaller resistances with shorter sections. Reactance at the feed-point terminals is tuned out by adjusting the length of the driven element, as necessary. If a fixed-length hairpin section is in use, a small range of adjustment may be made in the effective value of the inductance by spreading or squeezing together the conductors of the hairpin. Spreading the conductors apart will have the same effect as lengthening the hairpin, while placing them closer together will effectively shorten it.

**MATCHING STUBS**

As explained earlier in this chapter, a mismatch-terminated transmission line less than 1/4 wave-

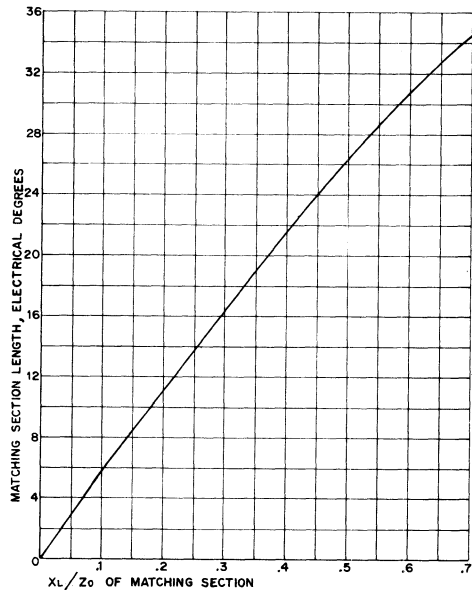

Fig. 3-72 — Inductive reactance (normalized to  $Z_0$  of matching section), scale at bottom, versus required matching-section length, scale at left. To determine the length in wavelengths, divide the number of electrical degrees by 360. For open-wire line, a velocity factor of 97.5% should be taken into account when determining the electrical length.

length long has an input impedance that is both resistive and reactive. The equivalent circuit of the line input impedance can be formed either of resistance and reactance in series or resistance and reactance in parallel. Depending on the line length, the series-resistance component,  $R_S$ , can have any value between the terminating resistance,  $Z_R$  (when the line has zero length) and  $Z_o^2/Z_R$  (when the line is exactly  $1/4$  wave long). The same thing is true of  $R_P$ , the parallel-resistance component. ( $R_S$  and  $R_P$  do not have the same values at the same line length, however, other than zero and  $1/4$  wavelength.) With either equivalent there is some line length that will give a value of  $R_S$  or  $R_P$  equal to the characteristic impedance of the line. However, there will always be reactance along with the resistance. But if provision is made for canceling or "tuning out" this reactive part of the input impedance, only the resistance will remain. Since this resistance is equal to the  $Z_o$  of the transmission line, the section from the reactance-cancellation point back to the generator will be properly matched.

Tuning out the reactance in the equivalent series circuit requires that a reactance of the same value as  $X_S$ , but of opposite kind, be inserted in series with the line. Tuning out the reactance in the equivalent parallel circuit requires that a reactance of the same value as  $X_P$  but of the opposite kind be connected across the line. In practice it is convenient to use the parallel-equivalent circuit. The transmission line is simply connected to the load (which of course is usually a resonant antenna) and then a reactance of the proper value is connected across the line at the proper distance from the load. From this point back to the transmitter there are no standing waves on the line.

A convenient type of reactance to use is a section of transmission line less than one-quarter wavelength long, either open-circuited or short-circuited, depending on whether capacitive reactance or inductive reactance is called for. Reactances formed from sections of transmission line are called *matching stubs*, and are designated as *open* or *closed* depending on whether the free end is open- or short-circuited. The two types of matching stubs are shown in the sketches of Fig. 3-73.

The distance from the load to the stub (dimension  $A$  in Fig. 3-73) and the length of the stub,  $B$ , depend on the characteristic impedances of the line and stub and on the ratio of  $Z_R$  to  $Z_o$ . Since the ratio of  $Z_R$  to  $Z_o$  is also the standing-wave ratio in the absence of matching, the dimensions are a function of the standing-wave ratio. If the line and stub have the same  $Z_o$ , dimensions  $A$  and  $B$  are dependent on the standing-wave ratio only. Consequently, if the standing-wave ratio can be measured before the stub is installed, the stub can be properly located and its length determined even though the actual value of load impedance is not known.

Typical applications of matching stubs are shown in Fig. 3-74, where open-wire line is being used. From inspection of these drawings it will be recognized that when an antenna is fed at a current

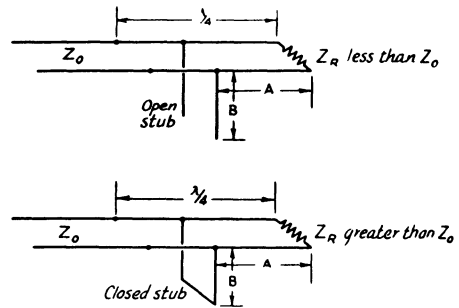

Fig. 3-73 — Use of open or closed stubs for canceling the parallel reactive component of input impedance.

loop, as in Fig. 3-74A,  $Z_R$  is less than  $Z_o$  (in the average case) and therefore an open stub is called for, installed within the first quarter wavelength of line measured from the antenna. Voltage feed, as at  $B$ , corresponds to  $Z_R$  greater than  $Z_o$  and therefore requires a closed stub.

The Smith Chart may be used to determine the length of the stub and its distance from the load (see later example). If the load is a pure resistance and the characteristic impedances of the line and stub are identical, the lengths may be determined by equations. For the closed stub when  $Z_R$  is greater than  $Z_o$ , they are

$$\tan A = \sqrt{\text{SWR}} \quad \text{and} \quad \cot B = \frac{\text{SWR} - 1}{\sqrt{\text{SWR}}}$$

For the open stub when  $Z_R$  is less than  $Z_o$

$$\cot A = \sqrt{\text{SWR}} \quad \text{and} \quad \tan B = \frac{\text{SWR} - 1}{\sqrt{\text{SWR}}}$$

In these equations the lengths  $A$  and  $B$  are the distance from the stub to the load and the length of the stub, respectively, as shown in Fig. 3-74. These lengths are expressed in electrical degrees, equal to 360 times the lengths in wavelengths.

In using the Smith Chart or the above equations it must be remembered that the wavelength along the line is not the same as in free space. If an open-wire line is used the velocity factor of 0.975 will apply. When solid-dielectric line is used the free-space wavelength as given by the curves must be multiplied by the appropriate velocity factor to obtain the actual length of  $A$  and  $B$  (See Table 3-1).

Although the equations above do not apply when the characteristic impedances of the line and stub are not the same, this does not mean that the line cannot be matched under such conditions. The stub can have any desired characteristic impedance if its length is chosen so that it has the proper value of reactance. Using the Smith Chart, the correct lengths can be determined without difficulty for dissimilar types of line.

In using matching stubs it should be noted that the length and location of the stub should be based on the standing-wave ratio *at the load*. If the line is long and has fairly high losses, measuring the SWR at the input end will not give the true value at the

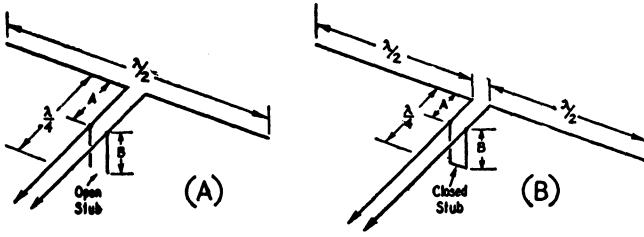

Fig. 3-74 - Application of matching stubs to common types of antennas.

load. This point was discussed earlier in this chapter in the section on attenuation.

**Reactive Loads**

In this discussion of matching stubs it has been assumed that the load is a pure resistance. This is the most desirable condition, since the antenna that represents the load preferably should be tuned to resonance before any attempt is made to match the line. Nevertheless, matching stubs can be used even when the load is considerably reactive. A reactive load simply means that the loops and nodes of the standing waves of voltage and current along the line do not occur at integral multiples of  $1/4$  wavelength from the load. To use the equations above it is necessary to find a point along the line at which a current loop or node occurs. Then the first set of equations gives the stub length and distance toward the transmitter from a current loop. The second set gives the stub length and distance toward the transmitter from a current node.

**Stubs on Coaxial Lines**

The principles outlined in the preceding section apply also to coaxial lines. The coaxial cases corresponding to the open-wire cases shown in Fig. 3-73 are given in Fig. 3-75. The equations given earlier may be used to determine the dimensions  $A$  and  $B$ . In a practical installation the junction of the transmission line and stub would be a T connector.

A special case of the use of a coaxial matching stub in which the stub is associated with the transmission line in such a way as to form a balun has been described earlier in this chapter (Fig. 3-58). The principles used are those just described. The antenna is shortened to introduce just enough reactance at its input terminals to permit the matching stub to be connected at that point, rather than at some other point along the transmission line as in the general cases discussed here. To use this method the antenna resistance must be lower than the  $Z_0$  of the main transmission line, since the resistance is transformed to a higher value. In beam antennas this will nearly always be the case.

**Matching Sections**

If the two antenna systems in Fig. 3-74 are redrawn in somewhat different fashion, as shown in Fig. 3-76, there results a system that differs in no consequential way from the matching stubs previously described, but in which the stub formed by  $A$  and  $B$  together is called a "quarter-wave

matching section." The justification for this is that a quarter-wave section of line is similar to a resonant circuit, as described earlier in this chapter, and it is therefore possible to use it to transform impedances by tapping at the appropriate point along the line.

Earlier equations give design data for matching sections,  $A$  being the distance from the antenna to the point at which the line is connected, and  $A + B$  being the total length of the matching section. The curves apply only in the case where the characteristic impedances of the matching section and transmission line are the same. Equations are available for the case where the matching section has a different  $Z_0$  than the line, but are somewhat complicated and will not be given here, since it is generally possible to make the line and matching section similar in construction.

**Adjustment**

In the experimental adjustment of any type of matched line it is necessary to measure the standing-wave ratio with fair accuracy in order to tell when the adjustments are being made in the proper direction. In the case of matching stubs, experience has shown that experimental adjustment is unnecessary, from a practical standpoint, if the SWR is first measured with the stub not connected to the transmission line, and the stub is then installed according to the design data.

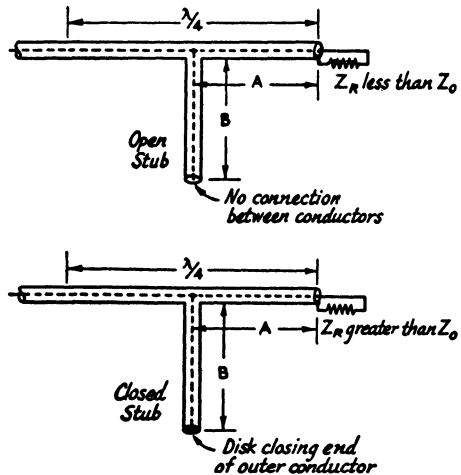

Fig. 3-75 - Open and closed stubs on coaxial lines.

## DESIGNING STUB MATCHES WITH THE SMITH CHART

Fig. 3-75A shows the case of a line terminated in a load impedance less than the characteristic impedance of the line, calling for an open (capacitive) stub for impedance matching. As an example, suppose that the antenna is a close-spaced array fed by a 52-ohm line, and that the standing-wave ratio has been determined to be 3.1:1. From this information, a constant-SWR circle may be drawn on the Smith Chart. Its radius is such that it intersects the lower portion of the resistance axis at the SWR value, 3.1, as shown in Fig. 3-77.

Since the stubs of Fig. 3-75 are connected in parallel with the transmission line, determining the design of the matching arrangement is simplified if Smith Chart values are dealt with as admittances, rather than impedances. (An admittance is simply the reciprocal of the associated impedance.) This leaves less chance for errors in making calculations, by eliminating the need for making series-equivalent to parallel-equivalent circuit conversions and back, or else for using complicated equations for determining the resultant value of two complex impedances connected in parallel.

A complex impedance,  $Z$ , is equal to  $R + jX$ , as described earlier in this chapter. The equivalent admittance,  $Y$ , is equal to  $G - jB$ , where  $G$  is the conductance component and  $B$  the susceptance. (Inductance is taken as negative susceptance, and capacitance as positive.) Conductance and susceptance values are plotted and handled on the Smith Chart in the same manner as are resistance and reactance. Because of the way in which the Smith Chart is designed, the coordinates for an admittance will be located at a point which is diametrically opposite the plot for its impedance counterpart — on the same SWR circle, but on the opposite side of prime center.

Assuming that the close-spaced array of the foregoing example has been resonated at the operating frequency, it will present a purely resistive termination for the load end of the 52-ohm line. From earlier information of this chapter, it is known that the impedance of the antenna equals  $Z_0/\text{SWR} = 52/3.1 \approx 16.8$  ohms. If this value were to be plotted as an impedance on the Smith Chart, it would first be normalized ( $16.8/52 = 0.32$ ) and then plotted as  $0.32 + j0$ . Although not necessary for the solution of this example, this value is plotted at point  $A$  in Fig. 3-77. What is necessary is a plot of the admittance for the antenna as a load. This is the reciprocal of

the impedance;  $1/16.8$  ohms equals 0.060 mho. To plot this point it is first normalized by multiplying the conductance and susceptance values by the  $Z_0$  of the line. Thus,  $(0.060 + j0) \times 52 = 3.1 + j0$ . This admittance value is shown plotted at point  $B$  in Fig. 3-77. It may be seen that points  $A$  and  $B$  are diametrically opposite each other on the chart.

Actually, for the solution of this example, it wasn't necessary to compute the values for either point  $A$  or point  $B$  as in the above paragraph, for they were both determined from the known SWR value of 3.1. As may be seen in Fig. 3-77, the points are located on the constant-SWR circle which was already drawn, at the two places where it intersects the resistance axis. The plotted value for point  $A$ , 0.32, is simply the reciprocal of the value for point  $B$ , 3.1. However, an understanding of the relationships between impedance and admittance is easier to gain with simple examples such as this.

In stub matching, the stub is to be connected at a point in the line where the conductive component equals the  $Z_0$  of the line. Point  $B$  represents the admittance of the load, which is the antenna. Various admittances will be encountered along the line, when moving in a direction indicated by the TOWARD GENERATOR wavelengths scale, but all admittance plots must fall on the constant-SWR circle. Moving clockwise around the SWR circle from point  $B$ , it is seen that the line input conductance will be 1.0 (normalized  $Z_0$  of the line) at point  $C$ ,  $0.082 \lambda$  toward the transmitter from the antenna. Thus, the stub should be connected at this location on the line.

The normalized admittance at point  $C$ , the point representing the location of the stub, is  $1 - j1.2$  mhos, having an inductive susceptance component. A capacitive susceptance having a normalized value of  $+j1.2$  mhos is required across the line at the point of stub connection, to cancel the inductance. This capacitance is to be obtained from the stub section itself; the problem now is to determine how long the stub should be. This is done by first plotting the susceptance required for cancellation,  $0 + j1.2$ , on the Chart (point  $D$  in Fig. 3-77). This point represents the input admittance as seen looking into the stub. The "load" or termination for the stub section is found by moving in the TOWARD LOAD direction around the chart, and will appear at the closest point on the resistance/conductance axis, either at the top or the bottom of the Chart. Moving counter-clockwise from point  $D$ , this is located at  $E$ , at the top of the chart,  $0.139 \lambda$  away. From this we know

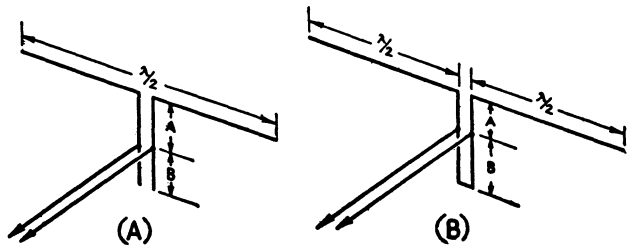

Fig. 3-76 — Application of matching sections to common antenna types.

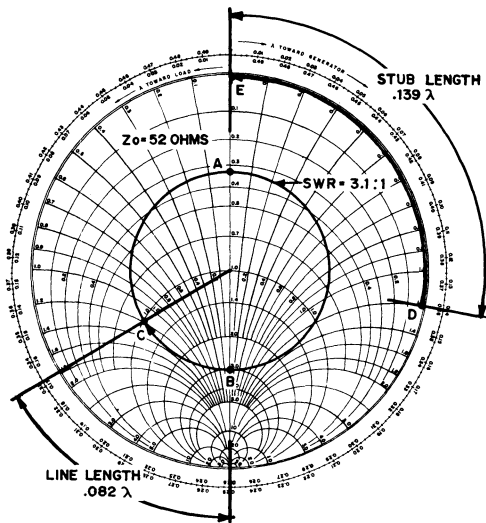

Fig. 3-77 — Smith Chart method of determining the dimensions for stub matching.

the required stub length. The “load” at the far end of the stub, from Fig. 3-75A, should be an open circuit. This load, as represented on the Smith Chart, has a normalized admittance of  $0 + j0$  mho, which is equivalent to an open circuit.

When the stub, having an input admittance of  $0 + j1.2$  mhos, is connected in parallel with the line at a point  $0.082 \lambda$  from the load, where the line input admittance is  $1.0 - j1.2$ , the resultant admittance is the sum of the individual admittances. The conductance components are added directly, as are the susceptance components. In this case,  $1.0 - j1.2 + j1.2 = 1.0 + j0$  mho. Thus, the line from the point of stub connection to the transmitter will be terminated in a load which offers a perfect match. When determining the physical line lengths for stub matching, it is important to remember that the velocity factor for the type of line in use must be considered.

### MATCHING WITH LUMPED CONSTANTS

It was pointed out earlier that the purpose of a matching stub is to cancel the reactive component of line impedance at the point of connection. In other words, the stub is simply a reactance of the proper kind and value shunted across the line. It does not matter what physical shape this reactance takes. It can be a section of transmission line or a “lumped” inductance or capacitance, as desired. In the above example with the Smith Chart solution, a capacitive reactance was required. A capacitor having the same value of reactance can be used just as well. There are cases where, from an installation standpoint, it may be considerably more convenient to use a capacitor in place of a stub. This is particularly true when open-wire feeders are used. If a variable capacitor is used, it becomes possible to adjust the capacitance to the exact value required.

The proper value of reactance may be determined from Smith Chart information. In the previous example, the required susceptance, *normalized*, was  $+j1.2$  mhos. This is converted into actual mhos by dividing by the line  $Z_0$ ;  $1.2/52 = 0.023$  mho, capacitive. The required capacitive reactance is the reciprocal of this latter value,  $1/0.023 = 43.5$  ohms. If the frequency is 14.2 MHz, for instance, 43.5 ohms corresponds to a capacitance of 258 pF. A 325-pF variable capacitor connected across the line  $0.082$  wavelength from the antenna terminals would provide ample adjustment range. The rms voltage across the capacitor is  $E = \sqrt{P \cdot Z_0}$  and for 500 watts, for example, would be  $E = \sqrt{500 \times 52} = 161$  volts. The peak voltage is 1.41 times the rms value, or 227 volts.

### FLEXIBLE SECTIONS FOR ROTATABLE ARRAYS

When open-wire transmission line is used there is likely to be trouble with shorting or grounding of feeders in rotatable arrays unless some special precautions are taken. Usually some form of insulated flexible line is connected between the antenna and a stationary support at the top of the tower or mast on which the antenna is mounted.

Such a flexible section can take several forms, and it can be made to do double duty. Probably the most satisfactory system, for arrays that are not designed to be fed with coaxial line, is to use a flexible section of coax with coaxial baluns at both ends. The outer conductor of the coax may be grounded to the tower or to the beam antenna framework, wherever it is advantageous to do so. Such a flexible section is shown in Fig. 3-78. If the coaxial section is made any multiple of a half wave in electrical length, the impedance of the array will be repeated at the bottom of the flexible section.

Another method is to use Twin-Lead for the flexible section. The 300-ohm tubular type designed for transmitting applications is recommended. Here, again, half-wave sections repeat the antenna feed impedance at the bottom end. The Twin-Lead section may also be made an odd multiple of a quarter wavelength, in which case it will act as a Q section, giving an impedance step-down between a 450-ohm line and an antenna impedance of 200 ohms.

### GROUND-PLANE ANTENNAS

The same principles discussed earlier also apply to an unsymmetrical system such as the grounded antenna or the ground-plane antenna. In the case of the quarter-wave ground-plane antenna a straightforward design procedure for matching is possible because the radiation resistance is essentially independent of the physical height of the system (provided the radiator is reasonably clear of other conductors in the vicinity) and there is no ground-connection resistance to be included in the total resistance to be matched.

The ground-plane antenna lends itself well to direct connection to coaxial line, so this type of line is nearly always used. Several matching

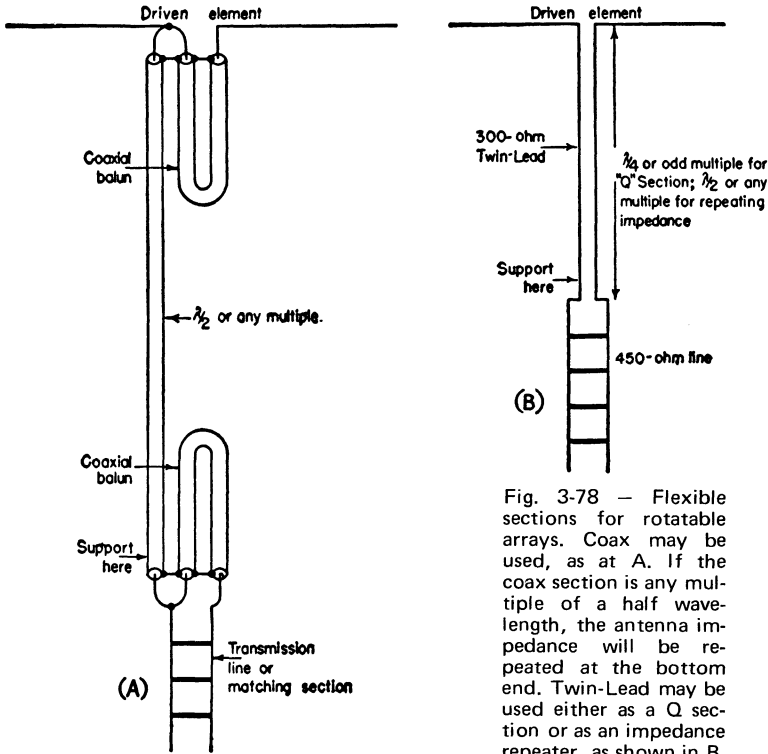

Fig. 3-78 — Flexible sections for rotatable arrays. Coax may be used, as at A. If the coax section is any multiple of a half wavelength, the antenna impedance will be repeated at the bottom end. Twin-Lead may be used either as a Q section or as an impedance repeater, as shown in B.

methods are available. If the antenna length can be adjusted to resonance, the stub matching system previously described is convenient.

A second method of matching, particularly convenient for small antennas (28 MHz and higher frequencies) mounted on top of a supporting mast or pole, requires shortening the antenna to the high-frequency side of resonance so that it shows a particular value of capacitive reactance at its base. The antenna terminals are then shunted by an inductive reactance, which may have the physical form either of a coil or a closed stub, to restore resonance and simultaneously transform the radiation resistance to the proper value for matching the transmission line. This concept is the same as for the hairpin match, described in detail in an earlier section.

### Tapped-Coil Matching

The matching arrangement shown in Fig. 3-79 is a more general form of the method just mentioned, in that it does not require adjusting the radiator height to an exact value. The radiator must be shortened so that the system will show capacitive reactance, but any convenient amount of shortening can be used. This system is particularly useful on lower frequencies where it may not be possible to obtain a height approximating a quarter wavelength.

The antenna impedance is matched to the characteristic impedance of the line by adjusting the taps on  $L$ . As a preliminary adjustment, before

attaching the line tap (2), the radiator tap (1) may be set for resonance at the operating frequency as indicated by a grid-dip meter coupled to  $L$ . The line tap (2) is then moved along the coil to find the point that gives minimum standing-wave ratio as indicated by an SWR indicator. To bring the SWR down to 1 to 1 it will usually then be necessary to make a small readjustment of the radiator tap (1) and perhaps further "touch up" the line tap (2), since the adjustments interact to some extent.

This method is equivalent to tapping down on a parallel-resonant circuit to match a low value of resistance to a higher value connected across the whole circuit. The antenna impedance can be represented by a capacitance in parallel with a resistance which is much higher than the actual radiation resistance. The transformation of resistance comes about by utilizing the parallel equivalent of the radiation resistance and capacitive reactance in series, using the relationships given in Fig. 3-15.

### Matching by Length Adjustment

Still another method of matching may be used when the antenna length is not fixed by other considerations. As shown in Chapter Two under *Special Antenna Types*, the radiation resistance as measured at the base of a ground-plane antenna increases with the antenna height, and it is possible to choose a height such that the base radiation resistance will equal the  $Z_0$  of the transmission line to be used. The heights of most interest are a little

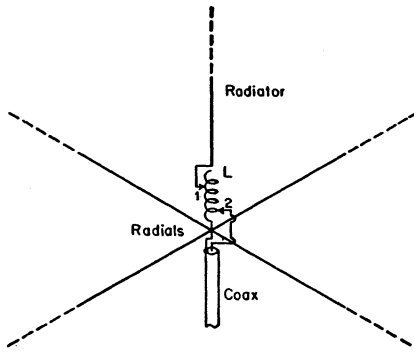

Fig. 3-79 — Matching to ground-plane antenna by tapped coil. This requires that the antenna (but not radials) be shorter than the resonant length.

over 100 degrees (0.28 wavelength), where the resistance is approximately 52 ohms, and about 113 degrees (0.32 wavelength), where the resistance is 75 ohms, to match the two common types of coaxial line. These heights are quite practicable for ground-plane antennas for 14 MHz and higher frequencies. The lengths (heights) in degrees as given above do not require any correction for length/diameter ratio; i.e., they are free-space lengths.

Since the antenna is not resonant at these lengths, its input impedance will be reactive as well as resistive. The reactance must be tuned out in order to make the line see a purely resistive load equal to its characteristic impedance. This can be done with a series capacitor of the proper value. The approximate value of capacitive reactance required, for antennas of typical length/diameter ratio, is about 100 ohms for the 52-ohm case and about 200 ohms for the 75-ohm case. The

corresponding capacitance values for the frequency in question can be determined from appropriate charts or by equation. Variable capacitors of sufficient range should be used.

In an analysis by Robert Stephens, W3MIR, the impedance and reactance versus height data of Chapter Two for ground-plane antennas has been converted to conductance and susceptance information. For parallel-equivalent matching, an input conductance of  $1/52$  mho is needed. For an antenna length-to-diameter ratio of approximately 1000, there are two heights for which the conductance is this value — one at  $0.234 \lambda$  and the other at  $0.255 \lambda$ . At the shorter height, the susceptance is positive (capacitive), 0.0178 mho, and at the longer it is negative, 0.0126 mho. So far as radiation is concerned, one is as good as the other, and the choice becomes the one of the simpler mechanical approach for the particular antenna. If the antenna is made 0.234 wavelength high, its capacitive reactance may be canceled with a shunt inductor having a reactance of 56 ohms at the operating frequency, resulting in a 52-ohm termination for the feed line. If the antenna is 0.255 wavelength, a 52-ohm match may be obtained with a shunt capacitor of 79 ohms. Similarly, a match may be obtained for 75-ohm coax with a height of 0.23 wavelength and a shunt inductor of 56 ohms, or with a height of 0.26 wavelength and a shunt capacitor of 78 ohms. These reactance values may be obtained with lumped constants or with stubs, as described earlier. As mentioned above, these heights do not require any correction factor; they are free-space lengths.

The adjustment of systems like these requires only that the capacitance or inductance be varied until the lowest possible SWR is obtained. If the lengths mentioned above are used, the SWR should be close enough to 1 to 1 to make a fine adjustment of the length unnecessary.

## BANDWIDTH AND ANTENNA Q

Although more properly a subject for discussion in connection with antenna fundamentals, the bandwidth of the antenna is considered here because as a practical matter the change in antenna impedance with frequency is reflected as a change in the standing-wave ratio on the transmission line. Thus when an antenna is matched to the line at one frequency — usually in the center of the band of frequencies over which the antenna is to be used — a shift in the operating frequency will be accompanied by a change in the SWR. This would not occur if the antenna impedance were purely resistive and constant regardless of frequency, but unfortunately no practical antennas are that “flat.”

In the frequency region around resonance the resistance change is fairly small and, by itself, would not affect the SWR enough to matter, practically. The principal cause of the change in SWR is the change in the reactive component of the antenna impedance when the frequency is varied. If the reactance changes rapidly with

frequency the SWR will rise rapidly off resonance, but if the rate of reactance change is small the shift in SWR likewise will be small. Hence an antenna that has a relatively slow rate of reactance change will cover a wider frequency band, for a given value of SWR at the band limits (such as 2 to 1 or 3 to 1), than one having a relatively rapid rate of reactance change.

In the region around the resonant frequency of the antenna the impedance as measured at a current loop varies with frequency in essentially the same way as the impedance of a series-resonant circuit using lumped constants. It is therefore possible to define a quantity  $Q$  for the antenna in the same way as  $Q$  is defined in a series-resonant circuit. The  $Q$  of the antenna is a measure of the antenna's selectivity, just as the  $Q$  of an ordinary circuit is a measure of its selectivity.

The  $Q$  of the antenna can be found by measuring its input resistance and reactance at some frequency close to the resonant frequency (at



Fig. 3-80 — Bandwidth in terms of SWR limits, as a function of antenna  $Q$ . The inset formula gives an effective  $Q$  ( $Q_1$ ) determined by the fractional band ( $\Delta f/f_0$ ) and the actual antenna  $Q$  as defined in the text.

exact resonance the antenna is purely resistive and there is no reactive component). Then, for frequency changes of less than 5 percent from the exact resonant frequency, the antenna  $Q$  is given with sufficient accuracy by the following formula:

$$Q = \frac{X}{R} \cdot \frac{1}{2n}$$

where  $X$  and  $R$  are the measured reactance and resistance and  $n$  is the percentage difference, expressed as a decimal, between the antenna's resonant frequency and the frequency at which  $X$  and  $R$  were measured. For example, if the frequency used for the measurement differs from the resonant frequency by 2 percent,  $n = 0.02$ .

For an ordinary half-wave dipole over the range of length/diameter ratios used in Fig. 2-7, Chapter Two, the approximate  $Q$  values vary from about 14 for curve  $A$  to about 8 for curve  $C$ . In parasitic arrays with close spacing between elements the input  $Q$  may be well over 50, depending on the spacing and tuning (see Chapter Four).

#### SWR vs. $Q$

If the  $Q$  of the antenna is known, the variation in SWR over the operating band can be determined from Fig. 3-80. It is assumed that the antenna is matched to the line at the center frequency of the band. Conversely, if a limit is set on the SWR, the width of the band that can be covered can be found from Fig. 3-80. As an example, suppose that a dipole having a  $Q$  of 15 (more or less typical of a wire antenna) is to be used over the 3.5-4 MHz band and that it is matched with a 1-to-1 SWR at the band center. Then  $\Delta f/f_0 = 0.5/3.75 = 0.133$  and  $Q_1 = 15 \times 0.133 = 2$ . The SWR that can be expected at the band edges, 3.5 and 4 MHz, is shown by the chart to be a bit over 4 to 1. If it should be decided arbitrarily that no more than a 2-to-1 standing-wave ratio is allowable,  $Q_1$  is 0.75 and from the formula in Fig. 3-80 the total bandwidth is found to be 187.5 kHz.

#### Effect of Matching Network

The measurement of resistance and reactance to determine  $Q$  should be made at the input terminals of the matching network, if one is required. The selectivity of the matching network has just as much effect on the bandwidth, in terms of SWR on the line, as the selectivity of the antenna itself. Where the greatest possible bandwidth is wanted a low- $Q$  matching network must be used. This is not always controllable, particularly when the antenna resistance differs considerably from the  $Z_0$  of the line to which it is to be matched. A large impedance ratio usually means that large values of

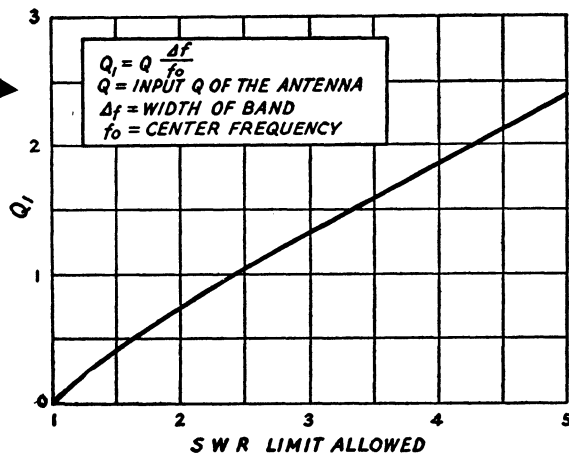

reactance must be used in the matching section; in other words, the  $Q$  of the matching section in such cases tends to be higher than desirable. Simple systems having direct matching, such as a dipole fed with 75-ohm line or a folded dipole matched to the line, will have the greatest bandwidth, other things being equal, because no matching network is required.

#### Bibliography

Source material and more extended discussion of topics covered in this chapter can be found in the references given below and in the textbooks listed at the end of Chapter Two.

- Armed Services Index of RF Transmission Lines and Fittings*, Armed Services Electro-Standards Agency, Ft. Monmouth, N.J.
- Belcher, "RF Matching Techniques, Design and Example," *QST*, October, 1972.
- Cholewski, "Some Amateur Applications of the Smith Chart," *QST*, January, 1960.
- Geiser, "Resistive Impedance Matching with Quarter-Wave Lines," *QST*, February, 1964.
- Gooch, Gardner and Roberts, "The Hairpin Match," *QST*, April, 1962.
- Grammer, "Simplified Design of Impedance-Matching Networks," *QST*, March, April, May, 1957.
- Grammer, "Antennas and Feeders," *QST*, October, November, December, 1963.
- Hall, "Smith-Chart Calculations for the Radio Amateur," *QST*, January, February, 1966.
- Healey, "An Examination of the Gamma Match," *QST*, April, 1969.
- Kraus and Sturgeon, "The T-Matched Antenna," *QST*, September, 1940.
- Maxwell, "Another Look at Reflections," *QST*, Apr., June, Aug., Oct. 1973, Apr., 1974.
- McCoy, "The Ultimate Transmatch," *QST*, July, 1970.
- Stephens, "Admittance Matching the Ground-Plane Antenna to Coaxial Transmission Line," *Technical Correspondence*, *QST*, April, 1973.
- Turrin, "Application of Broad-Band Balun Transformers," *QST*, April, 1969.

# Multielement Directive Arrays

The gain and directivity that can be secured by intentionally combining antenna elements into an array represent a worthwhile improvement both in transmitting and receiving. Power gain in an antenna is the same as an equivalent increase in the transmitter power. But, unlike increasing the power of one's own transmitter, it works equally well on signals received from the favored direction. In addition, the directivity reduces the strength of signals coming from the directions not favored, and so helps discriminate against a good deal of interference.

One common method of securing gain and directivity is to combine the radiation from a group of half-wave dipoles in such a way as to concentrate it in a desired direction. The way in which such combinations affect the directivity has been explained in Chapter Two. A few words of additional explanation may help make it clear how power gain is achieved.

In Fig. 4-1, imagine that the four circles, *A*, *B*, *C*, and *D* represent four dipoles so far separated from each other that the coupling between them is negligible. The point *P* is supposed to be so far away from the dipoles that the distance from *P* to each one is exactly the same (obviously *P* would have to be much farther away than it is shown in this drawing). Under these conditions the fields from all the dipoles will add up at *P* if all four are fed rf currents in the same phase.

Let us say that a certain current, *I*, in dipole *A* will produce a certain value of field strength, *E*, at the distant point *P*. The same current in any of the other dipoles will produce the same field at *P*. Thus if only dipoles *A* and *B* are operating, each with a

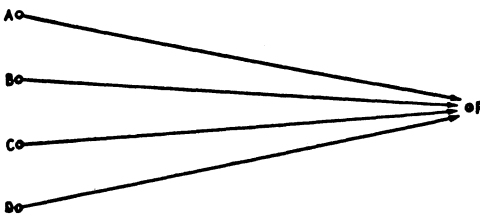

Fig. 4-1 — Fields from separate antennas combine at a distant point, *P*, to produce a field strength that exceeds the field produced by the same power in a single antenna.

current *I*, the field at *P* will be  $2E$ . With *A*, *B* and *C* operating, the field will be  $3E$ , and with all four operating with the same *I*, the field will be  $4E$ . Since the power received at *P* is proportional to the square of the field strength, the relative power received at *P* is 1, 4, 9, and 16, depending on whether one, two, three or four dipoles are operating.

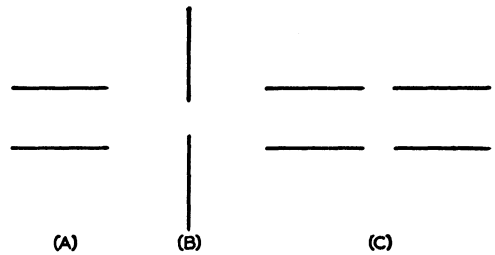

Fig. 4-2 — Parallel (A) and collinear (B) antenna elements. The array shown at C combines both parallel and collinear elements.

Now since all four dipoles are alike and there is no coupling between them, the same power must be put into each in order to cause the current *I* to flow. For two dipoles the relative power input is 2, for three dipoles it is 3, for four dipoles 4, and so on. The gain in each case is the relative received (or output) power divided by the relative input power. Thus we have:

Dipoles	Relative Output Power	Relative Input Power	Power Gain	Gain in dB
<i>A</i> only	1	1	1	0
<i>A</i> and <i>B</i>	4	2	2	3
<i>A</i> , <i>B</i> and <i>C</i>	9	3	3	4.8
<i>A</i> , <i>B</i> , <i>C</i> and <i>D</i>	16	4	4	6

The power gain is directly proportional to the number of elements used.

It is well to have clearly in mind the conditions under which this relationship is true:

- 1) The fields from the separate antenna elements must be in phase at the receiving point.

2) The currents in all elements must be identical.

3) The elements must be separated in such a way that the current induced in one by another is negligible, i.e., the radiation resistance of each element must be the same as it would have been had the other elements not been there.

Very few antenna arrays meet all these conditions exactly. However, as a rough approximation it may be said that the power gain of a directive array consisting of dipole elements in which optimum values of element spacing are used is proportional to the number of elements. It is not impossible, though, for an estimate based on this rule to be in error by a factor of 2 or more.

**Definitions**

The "element" in a multielement directive array is usually a half-wave dipole. The length is not always an exact electrical half wavelength, because in some types of arrays it is desirable that the element show either inductive or capacitive reactance. However, the departure in length from a true half-wave is ordinarily small (not more than 5%, in the usual case) and so has no appreciable effect on the radiating properties of the element.

Antenna elements in multielement arrays of the type considered in this chapter are always either

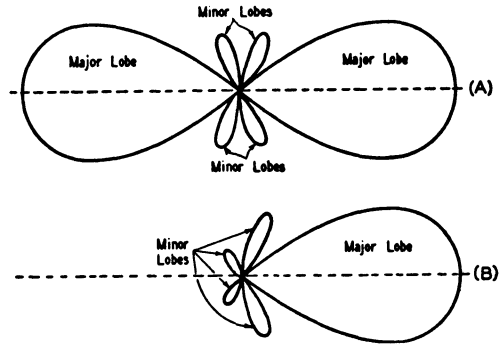

Fig. 4-4 — Typical bidirectional (A) and unidirectional (B) directive patterns. These drawings also illustrate the application of the terms "major" and "minor" to the pattern lobes.

parallel, as at A in Fig. 4-2, or collinear (end-to-end), Fig. 4-2B. Fig. 4-2C shows an array combining both parallel and collinear elements. The elements can be either horizontal or vertical, depending on whether horizontal or vertical polarization is desired. There is seldom any reason for mixing polarization, so arrays are customarily constructed with all elements similarly polarized.

A **driven element** is one supplied power from the transmitter, usually through a transmission line. A **parasitic element** is one that obtains power solely through coupling to another element in the array because of its proximity to such an element.

A **driven array** is one in which all the elements are driven elements. A **parasitic array** is one in which one or more of the elements are parasitic elements. At least one element in a parasitic array has to be a driven element, since it is necessary to introduce power into the array.

A **broadside array** is one in which the principal direction of radiation is perpendicular to the axis of the array and to the plane containing the elements. An **end-fire array** is one in which the principal direction of radiation coincides with the direction of the array axis. These definitions are illustrated by Fig. 4-3.

A **bidirectional array** is one that radiates equally well in either direction along the line of maximum radiation. A bidirectional pattern is shown in Fig. 4-4 at A. A **unidirectional array** is one that has only one principal direction of radiation, as illustrated by the pattern at B in Fig. 4-4.

The **major lobes** of the directive pattern are those in which the radiation is maximum. Lobes of lesser radiation intensity are called **minor lobes**. The **beamwidth** of a directive antenna is the width, in degrees, of the major lobe between the two directions at which the relative radiated power is equal to one half its value at the peak of the lobe. At these "half-power points" the field intensity is equal to 0.707 times its maximum value, or down 3 dB from maximum. Fig. 4-5 is an example of a lobe having a beam width of 30 degrees.

Unless specified otherwise, the term "gain" as used in this chapter is the power gain over a

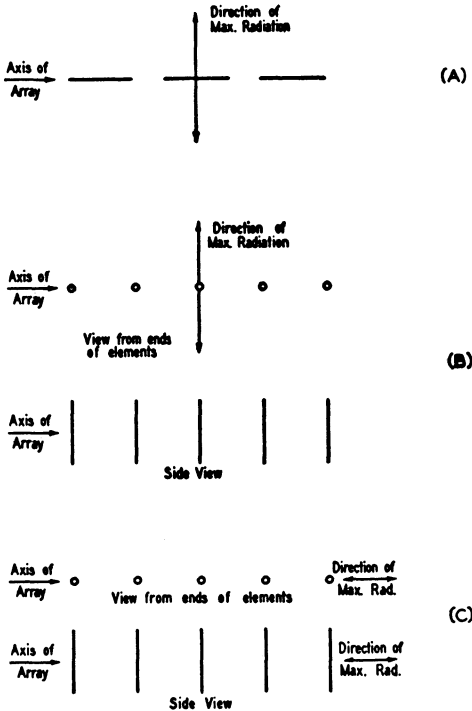

Fig. 4-3 — Representative broadside arrays are shown at A and B, the first with collinear elements, the second with parallel elements. An end-fire array is shown at C. Practical arrays may combine both broadside and end-fire directivity, including both parallel and collinear elements.

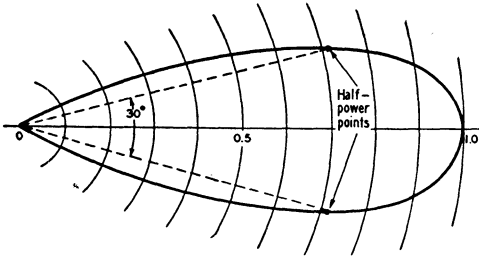

Fig. 4-5 — The width of a beam is the angular distance between the directions at which the received or transmitted power is one half the maximum power.

half-wave dipole of the same orientation and height as the array under discussion, and having the same power input. Gain may either be measured experimentally or determined by calculation. Experimental measurement is difficult and often subject to considerable error, since in addition to the normal errors in measurement (the accuracy of simple rf measuring equipment is relatively poor, and even high-quality instruments suffer in accuracy compared with their low-frequency and dc counterparts) the accuracy depends considerably on conditions — the antenna site, including height, terrain characteristics, and surroundings — under which the measurements are made. Calculations are frequently based on the measured or theoretical directive patterns (see Chapter Two) of the antenna. An approximate formula often used is

$$G = \frac{40,000}{\theta_H \theta_V}$$

where

- $G$  = gain over an *isotropic* antenna.
- $\theta_H$  = horizontal half-power beam width in degrees.
- $\theta_V$  = vertical half-power beam width in degrees.

This formula, strictly speaking, applies only to antennas having approximately equal and narrow  $E$  and  $H$ -plane (see Chapter Two) beamwidths — up to about 20 degrees — and no large minor lobes. The error may be considerable when the formula is applied to simple directive antennas having relatively large beamwidths. The error is in the direction of making the calculated gain larger than the actual gain.

**Front-to-back ratio** means the ratio of the power radiated in the favored direction to the power radiated in the opposite direction.

#### Phase

The term “phase” has the same meaning when used in connection with the currents flowing in antenna elements as it does in ordinary circuit work. For example, two currents are in phase when they reach their maximum values, flowing in the same direction, at the same instant. The direction of current flow depends on the way in which power is applied to the element.

This is illustrated in Fig. 4-6. Assume that by some means an identical voltage is applied to each of the dipoles at the end marked  $A$ . Assume also that the instantaneous polarity of the voltage is such that the current is flowing away from the point at which the voltage is applied. The arrows show the assumed current directions. Then the currents in elements 1 and 2 are completely in phase, since they are flowing in the same direction in space and are caused by the same voltage. However, the current in element 3 is flowing in the *opposite* direction in space because the voltage is applied to the opposite end of the element. The current in element 3 is therefore 180 degrees out of phase with the currents in elements 1 and 2.

The phasing of driven elements depends on the direction of the element, the phase of the applied voltage, and the point at which the voltage is applied. In the systems used by amateurs the voltages applied to the elements are practically always exactly in or exactly out of phase with each other. Also, the axes of the elements are always in the same direction, since parallel or collinear elements are invariably used. The currents in driven elements in such systems are therefore always either exactly in or out of phase with the currents in other elements.

It is possible to use phase differences of less than 180 degrees in driven arrays — one important case is where the voltage applied to one set of elements differs by 90 degrees from the voltage applied to another set — but such systems have not met with much application in amateur work. The reason probably is that making provision for proper phasing is considerably more of a problem than in the case of simple 0- or 180-degree phasing.

In parasitic arrays the phase of the currents in the parasitic elements depends on the spacing and tuning, as described later.

#### Ground Effects

The effect of the ground is the same with a directive antenna as it is with a simple dipole antenna. The reflection factors discussed in Chapter Two may therefore be applied to the vertical pattern of an array, subject to the same modifications mentioned in that chapter. In cases where the array elements are not all at the same height, the reflection factor for the *mean* height of the array must be used. The mean height is the average of the heights measured from the ground to the centers of the lowest and highest elements.

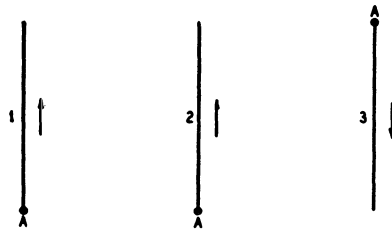

Fig. 4-6 — Illustrating phasing of currents in antenna elements.

**MUTUAL IMPEDANCE**

Consider two half-wave dipoles that are fairly close to each other. When power is applied to one and current flows, a voltage will be induced in the second by the electromagnetic field and current will flow in it as well. The current in antenna No. 2 will in turn induce a voltage in antenna No. 1, causing a current to flow in the latter. The total current in No. 1 is then the sum (taking phase into account) of the original current and the induced current.

If the voltage applied to antenna No. 1 has not changed, the fact that the amplitude of the current flowing is different, with antenna No. 2 present, than it would have been had No. 2 not been there indicates that the presence of the second antenna has changed the impedance of the first. This effect is called mutual coupling, and results in a **mutual impedance**. The actual impedance of an antenna element is the sum of its self-impedance (the impedance with no other antennas present) and its mutual impedance with all other antennas in the vicinity.

The magnitude and nature of the mutual impedance depends on the amplitude of the current induced in the first antenna by the second, and on the phase relationship between the original and induced currents. The amplitude and phase of the induced current depend on the spacing between the antennas and whether or not the second antenna is tuned to resonance.

**Amplitude of Induced Current**

The induced current will be largest when the two antennas are close together and are parallel. Under these conditions the voltage induced in the second antenna by the first, and in the first by the second, has its greatest value and causes the largest current flow. The coupling decreases as the parallel antennas are moved farther apart.

The coupling between collinear antennas is comparatively small, and so the mutual impedance between such antennas is likewise small. It is not negligible, however.

**Phase Relationships**

When the separation between the two antennas is an appreciable fraction of a wavelength a measurable period of time elapses before the field from antenna No. 1 reaches antenna No. 2 and there is a similar time lapse before the field set up by the current in No. 2 gets back to induce a current in No. 1. Hence the current induced in No. 1 by No. 2 will have a phase relationship with the original current in No. 1 that depends on the spacing between the two antennas.

The induced current can range all the way from being completely in phase with the original current to being completely out of phase with it. In the first case the total current is larger than the original current and the antenna impedance is reduced. In the second, the total current is smaller and the impedance is increased. At intermediate phase relationships the impedance will be lowered or

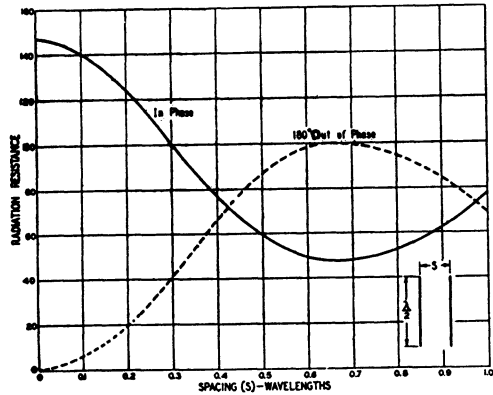

Fig. 4-7 — Radiation resistance measured at the center of one element as a function of the spacing between two parallel half-wave self-resonant antenna elements.

raised depending on whether the induced current is mostly in or mostly out of phase with the original current.

Except in the special cases when the induced current is exactly in or out of phase with the original current, the induced current causes the phase of the total current to shift with respect to the applied voltage. The mutual impedance, in other words, has both resistive and reactive components. Consequently, the presence of a second antenna nearby may cause the impedance of an antenna to be reactive — that is, the antenna will be detuned from resonance — even though its self-impedance is entirely resistive. The amount of detuning depends on the magnitude and phase of the induced current.

**Tuning Conditions**

A third factor that affects the impedance of antenna No. 1 when No. 2 is present is the tuning of the latter. If No. 2 is not exactly resonant the current that flows in it as a result of the induced voltage will either lead or lag the phase it would have had if the antenna were resonant. This causes an additional phase advance or delay that affects the phase of the current induced back in No. 1. Such a phase lag has an effect similar to change in the spacing between self-resonant antennas. However, a change in tuning is not exactly equivalent to a change in spacing because the two methods do not have the same effect on the amplitude of the induced current.

**Mutual Impedance and Gain**

The mutual impedance between antennas is important because it determines the amount of current that will flow for a given amount of power supplied. It must be remembered that it is the *current* that determines the field strength from the antenna. Other things being equal, if the mutual impedance between two antennas is such that the currents are greater for the same total power than would be the case if the two antennas were not

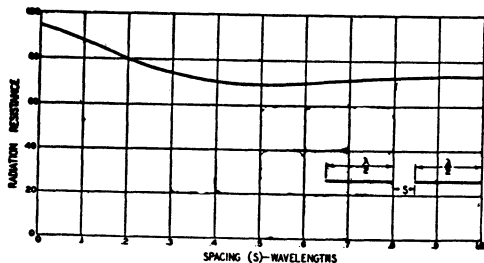

Fig. 4-8 — Radiation resistance measured at the center of one element as a function of the spacing between the ends of two collinear self-resonant half-wave antenna elements operated in phase.

coupled, the power gain will be greater than in the case discussed at the beginning of this chapter. On the other hand, if the mutual impedance is such as to reduce the current, the gain will be less than if the antennas were not coupled.

The calculation of mutual impedance between antennas is a difficult problem, but data are available for several special cases. Two simple but important ones are shown in Figs. 4-7 and 4-8. These graphs do not show the mutual impedance but instead show a more useful quantity, the radiation resistance measured at the center of an antenna as it is affected by the spacing between two antennas.

As shown by the solid curve in Fig. 4-7, the radiation resistance at the center of either dipole, when the two are self-resonant, parallel, and operated in phase, decreases rapidly as the spacing between them is increased until the spacing is

about 0.7 wavelength. The maximum gain is secured from a pair of such elements when the spacing is in this region, because the current is larger for the same power and the fields from the two arrive in phase at a distant point placed on a line perpendicular to the line joining the two antennas (see Fig. 2-17, Chapter Two).

The broken curve in Fig. 4-7 representing two antennas operated 180 degrees out of phase (end-fire), cannot be interpreted quite so simply. The radiation resistance decreases with decreasing spacing in this case. However, the fields from the two antennas add up in phase at a distant point in the favored direction only when the spacing is one-half wavelength (in the range of spacings considered). At smaller spacings the fields become increasingly out of phase, so the total field is less than the simple sum of the two. The latter factor decreases the gain at the same time that the reduction in radiation resistance is increasing it. As shown later in this chapter, the gain goes through a maximum when the spacing is in the region of 1/8 wavelength.

The curve for two collinear elements in phase, Fig. 4-8, shows that the radiation resistance decreases and goes through a broad minimum in the region of 0.3- to 0.5-wavelength spacing between the adjacent ends of the antennas. Since the minimum is not significantly less than the radiation resistance of an isolated antenna, the gain will not exceed the gain calculated on the basis of uncoupled antennas. That is, the best that two collinear elements will give, even with the optimum spacing, is a power gain of about 2 (3 dB). When the separation between the ends is very small — the usual method of operation — the gain is reduced.

## DRIVEN ARRAYS

Driven arrays may be either broadside or end-fire, and may consist of collinear elements, parallel elements, or a combination of both. The number of elements that it is practicable to use depends on the frequency and the space available for the antenna. Fairly elaborate arrays, using as many as 16 or even 32 elements, can be installed in a rather small space when the operating frequency is in the vhf range. At lower frequencies the construction of antennas with a large number of elements would be impracticable for most amateurs.

It is characteristic of broadside arrays that the power gain is proportional to the length of the array but is substantially independent of the number of elements used, provided the optimum element spacing is not exceeded. This means, for example, that a 5-element array and a 6-element array will have the same gain, provided the elements in both are spaced so that the overall array length is the same. Although this principle is seldom used for the purpose of reducing the number of elements, because of complications introduced in feeding power to each element in the proper phase, it does illustrate the fact that there is nothing to be gained by increasing the number of

elements if the space occupied by the antenna is not increased proportionally.

Generally speaking, the maximum gain in the smallest linear dimensions will result when the antenna combines both broadside and end-fire directivity and uses both parallel and collinear elements. In this way the antenna is spread over a greater volume of space, which has the same effect as extending its length to much greater extent in one linear direction.

### Feeding Driven Arrays

Not the least of the problems encountered in constructing multielement driven arrays is that of supplying the required amount of power to each element and making sure that the currents in the elements are in the proper phase. The directive patterns given in this chapter are based on the assumption that each element carries the same current and that the phasing is exact. If the element currents differ, or if the phasing is not proper, the actual directive patterns will not be quite like those shown. Small departures will not greatly affect the gain, but may increase the beam width and introduce minor lobes — or emphasize those that exist already.

If the directive properties of beam antennas are to be fully realized, care must be used to prevent antenna currents from flowing on transmission lines (see Chapter Three) used as interconnections between elements, as well as on the main transmission line. If radiation takes place from these lines, or if signals can be picked up on them, the directive effects may be masked by such stray radiation or pickup. Although this may not greatly affect the gain either in transmission or reception, received signals coming from undesired directions will not be suppressed to the extent that is possible with a well-designed system.

**COLLINEAR ARRAYS**

Collinear arrays are always operated with the elements in phase. (If alternate elements in such an array are out of phase, the system simply becomes a harmonic-type antenna.) A collinear array is a broadside radiator, the direction of maximum radiation being at right angles to the line of the antenna.

**Power Gain**

Because of the nature of the mutual impedance between collinear elements the radiation resistance is increased as shown in Fig. 4-8. For this reason the power gain does not increase in direct proportion to the number of elements. The gain with two elements, as the spacing between them is varied, is shown by Fig. 4-9. Although the gain is greatest when the end-to-end spacing is in the region of 0.3 to 0.5 wavelength, the use of spacings of this order is inconvenient constructionally and introduces problems in feeding the two elements. As a result, collinear elements are almost always operated with their ends quite close together – in wire antennas, usually with just a strain insulator between.

With very small spacing between the ends of adjacent elements the theoretical power gain of collinear arrays is approximately as follows:

- 2 collinear elements – 1.9 dB
- 3 collinear elements – 3.2 dB
- 4 collinear elements – 4.3 dB

More than four elements are rarely used.

**Directivity**

The directivity of a collinear array, in a plane containing the axis of the array, increases with its length. Small secondary lobes appear in the pattern when more than two elements are used, but the amplitudes of these lobes are low enough so that they are not important. In a plane at right angles to the array the directive diagram is a circle, no matter what the number of elements. Collinear operation, therefore, affects only the directivity in the plane containing the antenna. At right angles to the wire the pattern is the same as that of the half-wave elements of which it is composed.

When a collinear array is mounted with the elements vertical the antenna radiates equally well in all geographical directions. An array of such “stacked” collinear elements tends to confine the

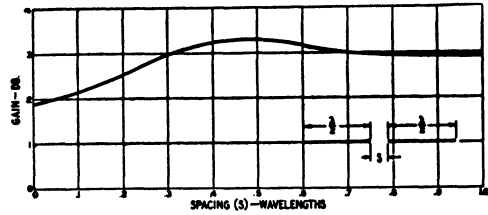

Fig. 4-9 – Gain of two collinear half-wave elements as a function of spacing between the adjacent ends.

radiation to low vertical angles. For purposes of estimating the effect of ground reflection the height is taken as the height of the center of the array. Applying the ground-reflection factor for this height (using the reflection factors given in Chapter Two for half-wave antennas) to the directive pattern of the array will give the resultant vertical pattern, taking into account ground reflection.

If a collinear array is mounted horizontally, the directive pattern in the vertical plane at right angles to the array is the same as the vertical pattern of a simple half-wave antenna at the same height (Chapter Two).

**Two-Element Array**

The simplest and most popular collinear array is one using two elements, as shown in Fig. 4-10. This system is commonly known as “two half-waves in phase,” and the manner in which the desired current distribution is secured has been described in Chapter Three. The directive pattern in a plane containing the wire axis is shown in Fig. 4-11.

Depending on the conductor size, height, and similar factors, the impedance at the feed point can be expected to be in the range from about 4000 to 6000 ohms, for wire antennas. If the elements are made of tubing having a low length/diameter ratio, values as low as 1000 ohms are representative. The system can be fed through an open-wire tuned line with negligible loss for ordinary line lengths, or a matching section may be used if desired.

**Three- and Four-Element Array**

When more than two collinear elements are used it is necessary to connect “phasing” stubs between adjacent elements in order to bring the

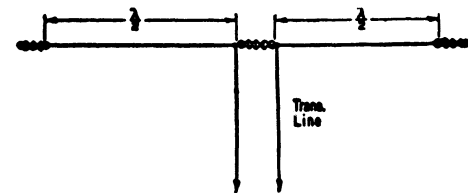

Fig. 4-10 – A two-element collinear array (“two half waves in phase”). The transmission line shown would operate as a tuned line. A matching section can be substituted and a nonresonant line used if desired.

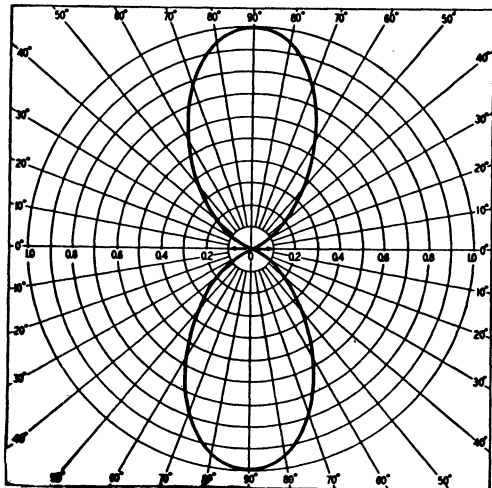

Fig. 4-11 — Free-space directive diagram for a two-element collinear array. Field strength is shown on a relative basis. This is the horizontal pattern at low wave angles when the array is horizontal.

currents in all elements in phase. It will be recalled from Chapter Two that in a long wire the direction of current flow reverses in each half-wave section. Consequently, collinear elements cannot simply be connected end to end; there must be some means for making the current flow in the same direction in all elements. In Fig. 4-12A the direction of current flow is correct in the two left-hand elements because the transmission line is connected between them. The phasing stub between the

second and third elements makes the instantaneous current direction correct in the third element. This stub may be looked upon simply as the alternate half-wave section of a long-wire antenna folded back on itself to cancel its radiation. In Fig. 4-12A the part to the right of the transmission line has a total length of three half wavelengths, the center half wave being folded back to form a quarter-wave phase-reversing stub. No data are available on the impedance at the feed point in this arrangement, but various considerations indicate that it should be over 1000 ohms.

An alternative method of feeding three collinear elements is shown in Fig. 4-12B. In this case power is applied at the center of the middle element and phase-reversing stubs are used between this element and both of the outer elements. The impedance at the feed point in this case is somewhat over 300 ohms and provides a close match to 300-ohm line. The SWR will be less than 2 to 1 when 600-ohm line is used. Center feed of this type is somewhat preferable to the arrangement in Fig. 4-12A because the system as a whole is balanced. This assures more uniform power distribution among the elements. In A, the right-hand element is likely to receive somewhat less power than the other two because a portion of the fed power is radiated by the middle element before it can reach the one located at the extreme right.

A four-element array is shown in Fig. 4-12C. The system is symmetrical when fed between the two center elements as shown. As in the three-element case, no data are available on the impedance at the feed point. However, the SWR with a 600-ohm line should not be much over 2 to 1. Fig. 4-13 shows the directive pattern of a four-element array. The sharpness of the three-element pattern is intermediate between Figs. 4-11 and 4-13, with a small minor lobe at right angles to the array axis.

Collinear arrays can be extended to more than four elements. However, the simple two-element collinear array is the type most used, for the reason that it lends itself well to multiband operation. More than two collinear elements are seldom used because more gain can be obtained from other types of arrays.

**Adjustment**

In any of the collinear systems described the lengths of the radiating elements in feet can be

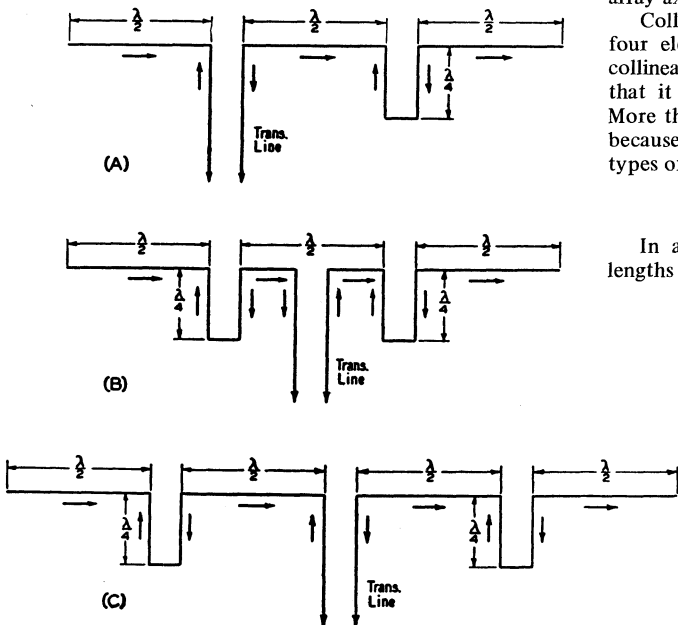

Fig. 4-12 — Three- and four-element collinear arrays. Alternative methods of feeding a three-element array are shown at A and B. These drawings also show the current distribution on the antenna elements and phasing stubs. A matched transmission line can be substituted for the tuned line by using a suitable matching section.



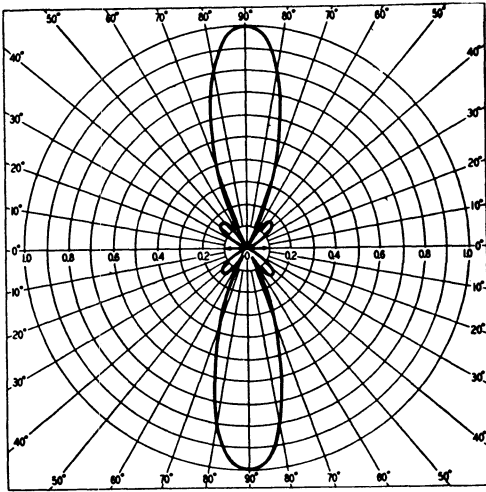

Fig. 4-13 — Free-space directive diagram for a four-element collinear array. Field strength is shown on a relative basis.

found from the formula  $468/f(\text{MHz})$ . The lengths of the phasing stubs can be found from the formulas given in Chapter Three for the type of line used. If the stub is open-wire line (500 to 600 ohms impedance) it is satisfactory to use a velocity factor of 0.975 in the formula for a quarter-wave line. On-the-ground adjustment is, in general, an unnecessary refinement. If desired, however, the following procedure may be used when the system has more than two elements.

Disconnect all stubs and all elements except those directly connected to the transmission line (in the case of feed such as is shown in Fig. 4-12B leave only the center element connected to the line). Adjust the elements to resonance, preferably using the still-connected element or method described in Chapter Three. When the proper length is determined, cut all other elements to the same length. Make the phasing stubs slightly long and use a shorting bar to adjust their length. Connect the elements to the stubs and adjust the stubs to resonance, as indicated by maximum current in the shorting bars or by the positions of the standing waves along the transmission line. When the whole system is resonant the position of the first current or voltage maximum along the transmission line should be the same as when the line is shorted or

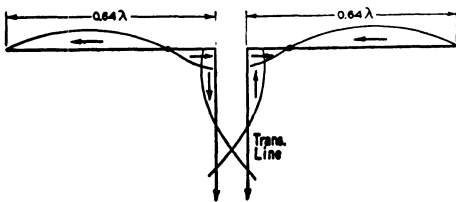

Fig. 4-14 — The extended double Zepp. This system gives somewhat more gain than two half-wave collinear elements.

open, as described in Chapter Three. If more than three or four elements are used it is best to add elements two at a time (one at each end of the array), resonating the system each time before a new pair is added.

**The Extended Double Zepp**

An expedient that may be adopted to obtain the higher gain that goes with wider spacing in a simple system of two collinear elements is to make the elements somewhat longer than  $1/2$  wavelength. As shown in Fig. 4-14, this increases the spacing between the two in-phase half-wave sections at the ends of the wires. The section in the center carries a current of opposite phase, but if this section is short the current will be small because it represents only the outer ends of a half-wave section. Because of the small current and short length the radiation from the center is small. The optimum length for each element is 0.64 wavelength. At greater lengths the system tends to act as a long-wire antenna and the gain decreases.

This system is known as the "extended double Zepp." The gain over a half-wave dipole is approximately 3 dB, as compared with slightly less than 2

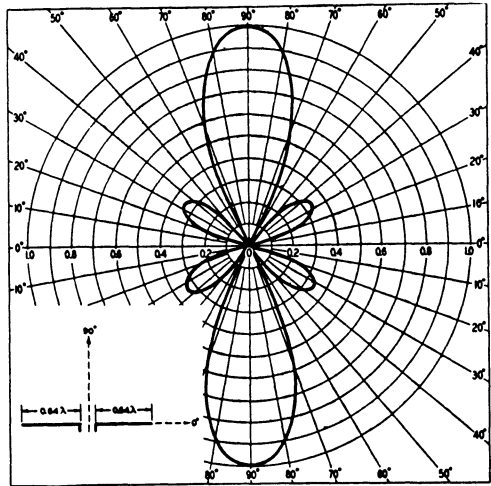

Fig. 4-15 — Free-space directive diagram for the extended double Zepp. This is also the horizontal directional pattern when the elements are horizontal.

dB for two collinear dipoles. The directional pattern in the plane containing the axis of the antenna is shown in Fig. 4-15. As in the case of all other collinear arrays, the free-space pattern in the plane at right angles to the antenna elements is the same as that of a half-wave antenna; i.e., is circular.

**BROADSIDE ARRAYS WITH PARALLEL ELEMENTS**

To obtain broadside directivity with parallel elements the currents in the elements must all be in phase. At a distant point lying on a line perpen-

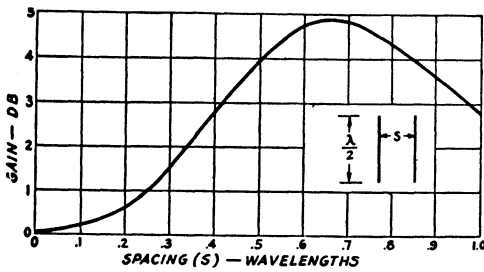

Fig. 4-16 — Power gain as a function of the spacing between two parallel elements operated in phase (broadside).

dicular to the axis of the array and also perpendicular to the plane containing the elements, the fields from all elements add up in phase. The situation is similar to that pictured in Fig. 4-1 in this chapter and in Fig. 2-17, Chapter Two.

Broadside arrays of this type theoretically can have any number of elements. However, practical limitations of construction and available space usually limit the number of broadside parallel elements to two, in the amateur bands below 30 MHz, when horizontal polarization is used. More than four such elements seldom are used even at vhf.

**Power Gain**

The power gain of a parallel-element broadside array depends on the spacing between elements as well as on the number of elements. The way in which the gain of a two-element array varies with spacing is shown in Fig. 4-16. The greatest gain is obtained when the spacing is in the vicinity of 0.7 wavelength.

The theoretical gains of broadside arrays having more than two elements are approximately as follows:

No. of Parallel Elements	dB Gain with 1/2-Wave Spacing	dB Gain with 3/4-Wave Spacing
3	5	7
4	6	8.5
5	7	10
6	8	11

The elements must, of course, all lie in the same plane.

**Directivity**

The sharpness of the directive pattern depends on spacing between elements and on the number of elements. Larger element spacing will sharpen the main lobe, for a given number of elements. The two-element array has no minor lobes when the spacing is 1/2 wavelength, but small minor lobes appear at greater spacings. When three or more elements are used the pattern always has minor lobes.

The vertical directive pattern of such an array when the elements are vertical is the same as that for a simple half-wave dipole at the same height.

The patterns are given in Chapter Two. When the array elements are horizontal the vertical pattern is the product of the broadside pattern for the particular array used multiplied by the ground-reflection factors given in Chapter Two. For the purpose of applying the ground-reflection factor the height of the array is taken as the mean height above ground. The horizontal directive pattern of a horizontally polarized parallel-element broadside array is the same as that of a simple dipole.

**Two-Element Arrays**

The elements of a broadside array must be connected by transmission lines that supply power in the proper phase to each element. Three methods of interconnection for a two-element array are given in Fig. 4-17. In A, the main transmission line is connected to the "phasing line" at its center. The two halves of the phasing line, AB and AC are simply in parallel, as far as the main transmission line is concerned, so the currents in the phasing line flow in opposite directions, with respect to the junction A. This brings the currents in the array elements in phase. The phasing line can be any convenient length in this case, so the line spacing between the two elements can be any value desired. Although no data are available on impedances, a rough estimate indicates that in most practical cases the impedance will be well below 100 ohms at the point where the main transmission line joins the phasing line, assuming a half-wave phasing line having a Zo of about 600 ohms. If the

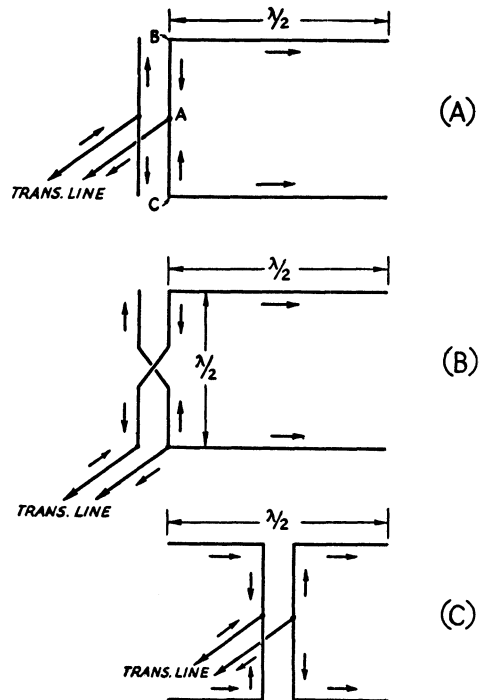

Fig. 4-17 — Two-element broadside arrays, showing different methods of supplying power.

phasing line is not exactly 1/2 wavelength long the impedance will be reactive as well as resistive.

In B, the main transmission line is connected at the junction of the phasing line and one element. In this case it is necessary to transpose the phasing line somewhere along its length so that the element currents will be in the proper phase. This is shown by the arrows indicating relative direction of current flow. The impedance at the feed point will be resistive and of the order of a few thousand ohms when the elements and phasing line all have electrical lengths of 1/2 wavelength. With this type of feed the spacing between the elements is determined by the electrical length of the phasing line; it must be an electrical half wave long to bring the element currents in proper phase. Open-wire lines are always used as phasing lines in this type of system because their electrical length is nearest to the length of an actual half wavelength in space. If the velocity factor of the phasing line is much less than 1 the antenna elements will perform be considerably less than a half wavelength apart, and this will reduce the gain.

A third method of feeding is shown at C. This is the best of the three, insofar as symmetry is concerned. The spacing between the two elements can be any desired value. However, when the spacing is one-half wavelength the impedance at the point where the main transmission line is connected is resistive and can be calculated with the aid of Fig. 4-7. For example, Fig. 4-7 shows that the radiation resistance of each element is approximately 60 ohms at half-wave spacing. If the  $Z_0$  of the phasing line is 600 ohms, the impedance reflected at the transmission-line terminals will be  $600^2/60 = 6000$  ohms, since with half-wave spacing the phasing line is 1/4 wave long from the element to the junction. As the reflected resistances from both elements are in parallel, the

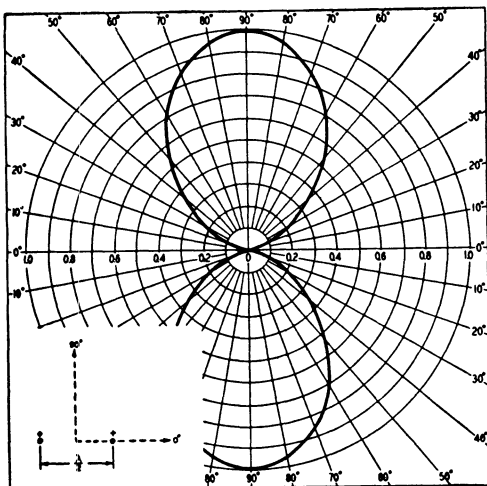

Fig. 4-18 — Free-space directive diagram of a two-element broadside array for an element spacing of 1/2 wavelength. This drawing gives the low-angle horizontal pattern of a vertically polarized array.

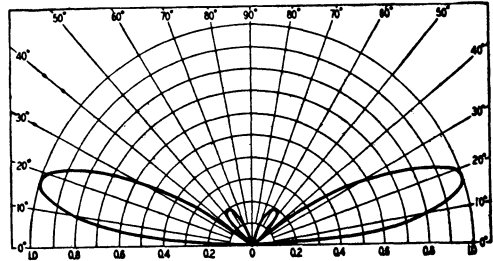

Fig. 4-19 — Vertical pattern broadside to a two-element in-phase array with horizontal elements. This pattern is for a mean height of 3/4 wavelength, i.e., lower element 1/2 wavelength high and upper element one wavelength high. At low wave angles, the horizontal pattern of such an array is the same as for a half-wave dipole.

resistive impedance seen by the transmission line is  $6000/2 = 3000$  ohms.

The arrays shown in Fig. 4-17 may be installed either vertically or horizontally, depending on the type of polarization desired. The free-space directive diagram given in Fig. 4-18 is also the horizontal pattern of the array at low wave angles when the elements are vertical. The vertical pattern for a horizontally polarized two-element array for a mean height of 3/4 wavelength is given in Fig. 4-19. The pattern for other heights may be found by multiplying the pattern of Fig. 4-18 by the ground-reflection factor for the actual mean height.

### END-FIRE ARRAYS

The term "end-fire" covers a number of different methods of operation, all having in common the fact that the maximum radiation takes place along the array axis, and that the array consists of a number of parallel elements in one plane. End-fire arrays can be either bidirectional or unidirectional. In the bidirectional type commonly used by amateurs there are only two elements, and these are operated with currents 180 degrees out of phase. Unidirectional end-fire driven arrays have not had much amateur use because the element phasing is neither 0 nor 180 degrees and tends to be complicated from an adjustment standpoint. (Instead, unidirectional antennas as used by amateurs are practically all based on the use of parasitic elements as described later in this chapter.)

#### Two-Element Arrays

In the two-element array with equal currents out of phase the gain varies with the spacing between elements as shown in Fig. 4-20. The maximum gain is in the neighborhood of 1/8-wave spacing. Below .05-wave spacing the gain decreases rapidly, since the system is approaching the spacing used for nonradiating transmission lines.

The radiation resistance at the center of either element is very low at the spacings giving the greatest gain, as shown by Fig. 4-7. The spacings

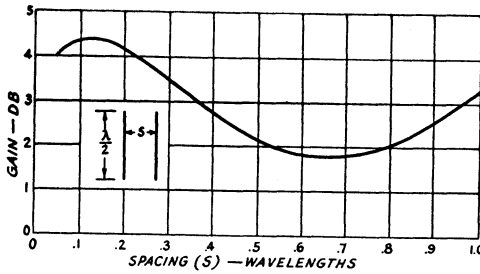

Fig. 4-20 — Gain of an end-fire array consisting of two elements fed 180 degrees out of phase, as a function of the spacing between elements. Maximum radiation is in the plane of the elements and at right angles to them at spacings up to 0.5 wavelength, but the direction changes at greater spacings.

most frequently used are 1/8 and 1/4 wavelength, at which the resistances are about 8 and 32 ohms, respectively. When the spacing is 1/8 wavelength it is advisable to use good-sized conductors — preferably tubing — for the elements because with the radiation resistance so low the heat losses in the conductor can represent an appreciable portion of the power supplied to the antenna. Excessive

conductor loss will mean that the theoretical gain cannot be realized.

Three methods of feeding bidirectional end-fire elements are shown in Fig. 4-21. In A, one section of the phasing line is transposed to bring the element currents in proper phase. The method at B is suitable for close-spaced (i.e., 1/8-wave) arrays because each half of the connecting wire is only 1/16 wave long and carries very little current. Hence there is very little radiation from the wires joining the ends of the elements to the transmission line even though the currents are in phase. The center-fed arrangement shown at C is especially useful when the antenna is to be operated on two bands — for example, 14 and 28 MHz — the higher of which is the second harmonic of the lower.

Because of the very low radiation resistance when the spacing,  $S$  in Fig. 4-21, is 1/8 wavelength, the SWR on the transmission line is very high. No figures are available for the end-fed cases, but it can be estimated to be 20 to 1 or higher. With center feed using a 600-ohm line the SWR is over 30 to 1; if the transmission line has any considerable distance to run, it is advisable to match it to the antenna by using a matching section of the type described in Chapter Three. Such a matching section should be of open-wire

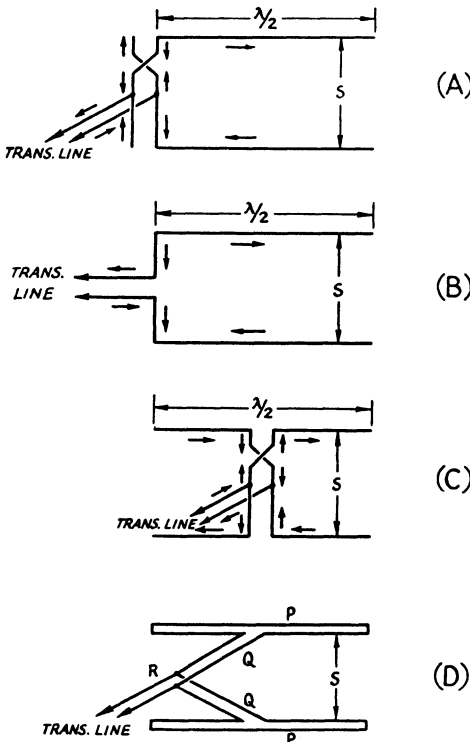

Fig. 4-21 — Parallel-element end-fire array with various methods of feed, showing current distribution. Matching sections for making the transmission line nonresonant, as described in Chapter Three, may be used in the first three cases. The distance  $S$  may be selected from Fig. 4-20.

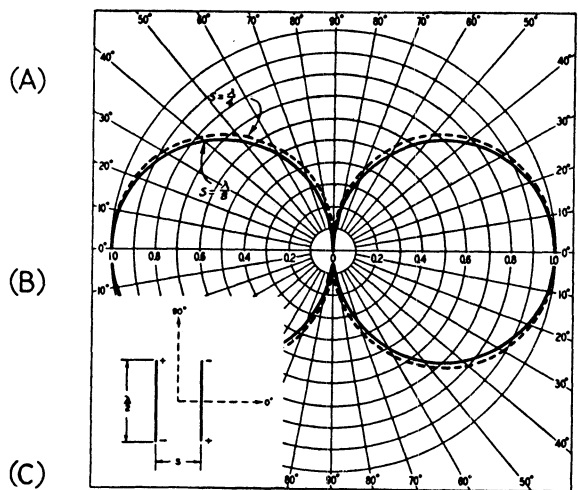

Fig. 4-22 — Free-space directive diagram of a two-element end-fire array with 180-degree phasing, in the plane containing the two parallel elements.

construction in view of the high SWR. The line itself, of course, can be any type capable of carrying the transmitter power. If the transmission line does not have to run more than a wavelength or two it may be of open-wire construction and operated as a tuned line.

With 1/4-wave spacing the increased radiation resistance will lower the SWR considerably. With center feed it will be about 10 to 1 (600 ohm line), and should not exceed that figure with end feed.

In a close-spaced array fed through a tuned transmission line the element lengths are not

**Multielement Directive Arrays**

critical; the only point to watch is to preserve the symmetry of the system as a whole. When a matching section is used, however, it is necessary to adjust the system accurately to the particular frequency to be used most. The low radiation resistance makes the antenna a sharply tuned affair, and so relatively small departures from the design frequency will throw off the impedance match.

Another way of overcoming the high SWR on the transmission line, and at the same time reducing the resistance loss in the antenna elements, is to use a folded-dipole (see Chapter Two) arrangement as indicated at D in Fig. 4-21. In this way the impedance at the element terminals is stepped up, and then there is a further impedance step-up in the section *Q* which is a quarter-wave *Q*-type matching transformer. A number of combinations is listed below.

<i>S</i> , wave- length	No. of conductors in dipole	<i>Z</i> <sub>0</sub> of 1/4- wave match- ing section	<i>Z</i> <sub>0</sub> of main transmis- sion line
1/8	1	75	300
1/8	2	75	75
1/8	3	300	600
1/8	4	300	300
1/4	1	75	75
1/4	2	300	300
1/4	3	600	600

In each case the SWR on the transmission line will be well below 2 to 1. Twin-Lead will be satisfactory for the 75 and 300-ohm line. The velocity factor of the line must be taken into account in determining the physical length of the 1/4-wave matching transformer. In all the arrangements listed above except those using plain dipoles as elements the frequency characteristic of the antenna will be broadened somewhat by the folded-dipole construction.

The free-space directive pattern in the plane containing the array is given in Fig. 4-22 and the corresponding pattern in the plane at right angles to the array plane is given in Fig. 4-23. Fig. 4-22 is also the horizontal directive pattern of the array at low wave angles when the elements are horizontal, while Fig. 4-23 is the horizontal pattern at low wave angles when the elements are vertical. The vertical pattern of a horizontally polarized array is shown in Fig. 4-24.

**Unidirectional End-Fire Arrays**

Two parallel elements spaced 1/4 wavelength apart and fed equal currents 90 degrees out of phase will have a directional pattern, in the plane at right angles to the plane of the array, as represented in Fig. 4-25. The maximum radiation is in the direction from the element in which the current leads to the element in which the current lags. In the opposite direction the fields from the two elements cancel.

One way in which the 90-degree phase difference can be obtained is shown in Fig. 4-26. Each element must be matched to its transmission line, the two lines being of the same type except that

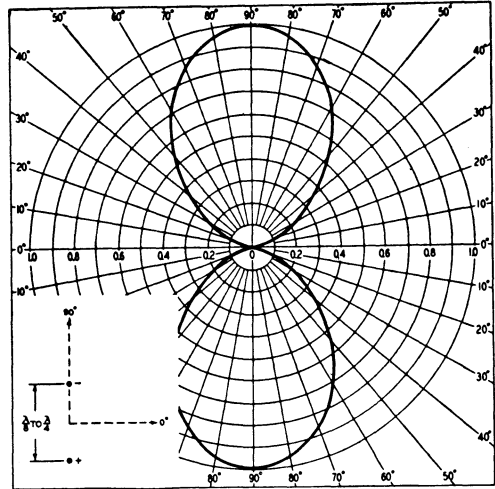

Fig. 4-23 - Free-space directive diagram of a two-element end-fire array with 180-degree phasing, in the plane at right angles to the plane containing the elements.

one is an electrical quarter wavelength longer than the other. The length *L* can be any convenient value. Open quarter-wave matching sections are shown, but half-wave shorted sections could be used instead. The two transmission lines are connected in parallel at the transmitter coupling circuit.

When the currents in the elements are neither in phase nor 180 degrees out of phase the radiation resistances of the elements are not equal. This complicates the problem of feeding equal currents to the elements. If the currents are not equal one or more minor lobes will appear in the pattern and decrease the front-to-back ratio. The adjustment process is likely to be tedious and requires field-strength measurements in order to get the best performance.

More than two elements can be used in unidirectional end-fire array. The requirement for unidirectivity is that there must be a progressive phase shift in the element currents equal to the spacing, in electrical degrees, between the elements, and the amplitudes of the currents in the various elements also must be properly related.

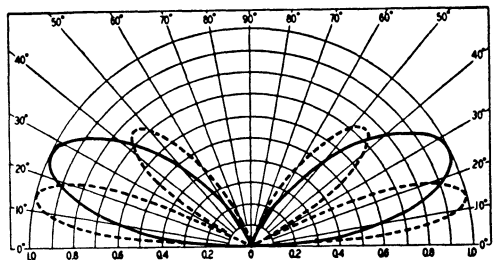

Fig. 4-24 - Vertical pattern of a horizontally polarized two-element end-fire array. Solid curve, height 1/2 wavelength; broken curve, height 1 wavelength.

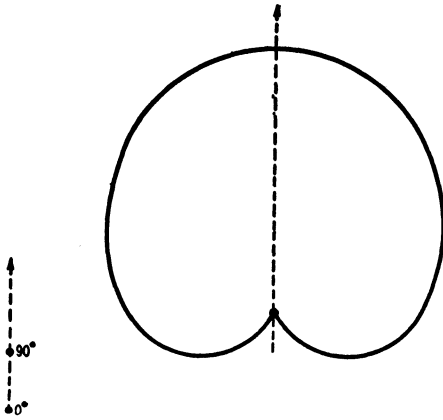

Fig. 4-25 — Representative pattern for a two-element end-fire array with 90-degree phasing, in the plane perpendicular to the plane containing the elements.

This requires “binomial” current distribution — i.e., the ratios of the currents in the elements must be proportional to the coefficients of the binomial series. In the case of three elements, this requires that the current in the center element be twice that in the two outside elements, for 90-degree (quarter-wave) spacing and element current phasing. This antenna has an overall length of  $1/2$  wavelength.

**COMBINATION DRIVEN ARRAYS**

Broadside, end-fire and collinear elements can readily be combined to increase gain and directivity, and this is in fact usually done when more than two elements are used in an array. Combinations of this type give more gain, in a given amount of space, than plain arrays of the types just described.

The combinations that can be worked out are almost endless, but in this section we shall describe

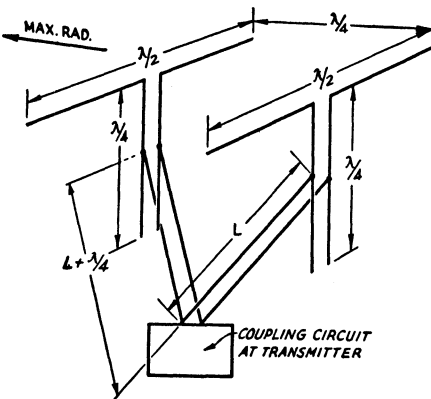

Fig. 4-26 — Unidirectional two-element end-fire array and method of obtaining 90-degree phasing.

only a few of the simpler types that are in common use. The drawings that follow all show the elements arranged for horizontal polarization, which is customary on the frequencies below 30 MHz where these arrays find their greatest application. For vertical polarization the arrays should be rotated 90 degrees so that the elements are vertical — that is, “stood on end.”

Other methods of interconnecting elements than those shown in the drawings may be used. However, the methods shown are recommended over others for two reasons: The antenna system is symmetrical with respect to the feed point, thus making the current distribution among elements as uniform as possible; the lengths of phasing lines (and antenna elements as well) are not critical so long as the lengths of lines radiating from a junction are all the same. With other feed methods this may not be true, and it becomes necessary to use the methods described in Chapter Three to ensure that elements and phasing lines are exactly resonant at the design frequency, if maximum

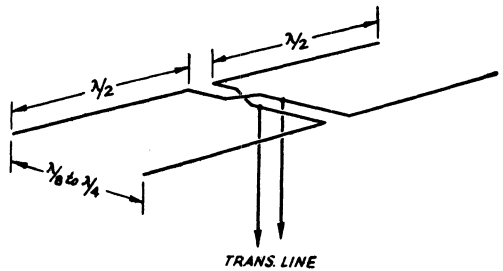

Fig. 4-27 — A four-element array combining collinear broadside elements and parallel end-fire elements.

performance is to be secured from the antenna. This adjustment process can be rather difficult as well as tedious. If the feed arrangements shown in the drawings are followed the lengths of wire elements in feet can be found from  $468/f$  (MHz), the element spacings from  $984/f$  (MHz) multiplied by the fraction of wavelength desired, and the phasing lines can simply be cut to fit, keeping all lines the same length.

**Gain of Combination Arrays**

The accurate calculation of the power gain of a multielement array requires a knowledge of the mutual impedances between all elements. For approximate purposes it is sufficient to assume that each set (collinear, broadside, end-fire) will have the gains as given earlier, and then simply add up the gains for the combination. This neglects the effects of cross-coupling between sets of elements. However, the array configurations are such that the mutual impedances from cross-coupling should be relatively small, particularly when the spacings are  $1/4$  wavelength or more, so that the estimated gain should be reasonably close to the actual gain.

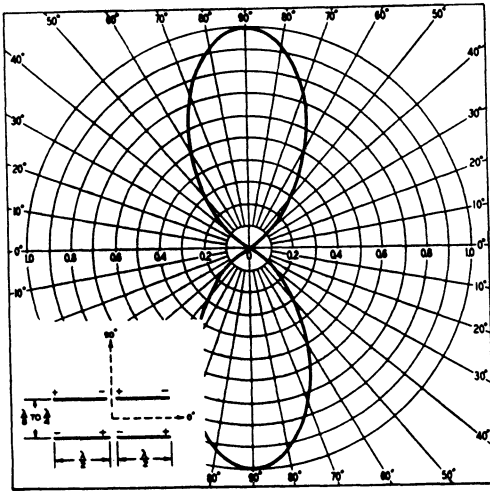

Fig. 4-28 — Free-space directive diagram of the antenna shown in Fig. 4-27, in the plane of the antenna elements. The pattern in the plane perpendicular to the element plane is the same as Fig. 4-23.

**Four-Element End-Fire and Collinear Array**

The array shown in Fig. 4-27 combines collinear in-phase elements with parallel out-of-phase elements to give both broadside and end-fire directivity. It is popularly known as a “two-section W8JK” or “two-section flat-top beam.” The approximate gain calculated as described above is 6.2 dB with 1/8-wave spacing and 5.7 dB with 1/4-wave spacing. Directive patterns are given in Figs. 4-28 and 4-29.

The impedance between elements at the point where the phasing line is connected is of the order of several thousand ohms. The SWR with an unmatched line consequently is quite high, and this system should be constructed with open-wire line (500 or 600 ohms) if the line is to be resonant. To use a matched line a closed stub 3/16 wavelength long can be connected at the transmission-line junction shown in Fig. 4-27, and the transmission line itself can then be tapped on this matching

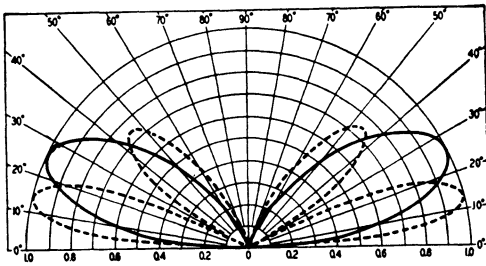

Fig. 4-29 — Vertical pattern of the four-element antenna of Fig. 4-27 when mounted horizontally. Solid curve, height 1/2 wavelength; broken curve, height 1 wavelength. Fig. 4-28 gives the horizontal pattern.

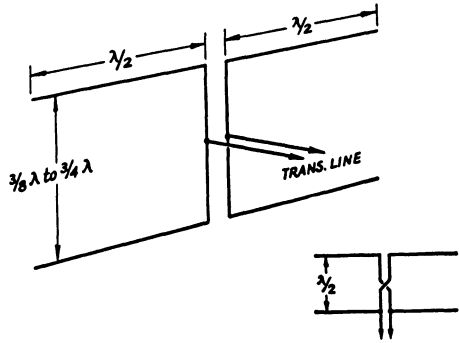

Fig. 4-30 — Four-element broadside array (“lazy-H”) using collinear and parallel elements.

section at the point resulting in the lowest line SWR. This point can be determined by trial.

With 1/4-wave spacing the SWR on a 600-ohm line is estimated to be in the vicinity of 3 or 4 to 1.

This type of antenna can be operated on two bands having a frequency ratio of 2 to 1, if a resonant feed line is used. For example, if designed for 28 MHz with 1/4-wave spacing between elements it can be operated on 14 MHz as a simple end-fire array (Fig. 4-21C) having 1/8-wave spacing.

**Four-Element Broadside Array**

The four-element array shown in Fig. 4-30 is commonly known as the “lazy-H.” It consists of a set of two collinear elements and a set of two parallel elements, all operated in phase to give broadside directivity. The gain and directivity will depend on the spacing, as in the case of a simple parallel-element broadside array. The spacing may be chosen between the limits shown on the drawing, but spacings below 3/8 wavelength are not worthwhile because the gain is small. Estimated gains are as follows

- 3/8-wave spacing — 4.4 dB
- 1/2-wave spacing — 5.9 dB
- 5/8-wave spacing — 6.7 dB
- 3/4-wave spacing — 6.6 dB

Half-wave spacing is generally used. Directive patterns for this spacing are given in Figs. 4-31 and 4-32.

With half-wave spacing between parallel elements the impedance at the junction of the phasing line and transmission line is resistive and is in the vicinity of 100 ohms. With larger or smaller spacing the impedance at this junction will be reactive as well as resistive. Matching stubs are recommended in cases where a nonresonant line is to be used. They may be calculated and adjusted as described in Chapter Three.

The system shown in Fig. 4-30 may be used on two bands having a 2-to-1 frequency relationship. It should be designed for the higher of the two frequencies, using 3/4-wave spacing between parallel elements. It will then operate on the lower

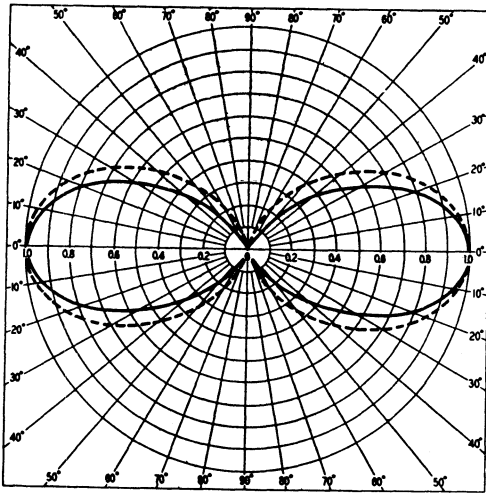

Fig. 4-31 - Free-space directive diagrams of the four-element antenna shown in Fig. 4-30. The solid curve is the horizontal directive pattern at low wave angles when the antenna is mounted with the elements horizontal. The broken curve is the free-space vertical pattern of a horizontally polarized array, broadside to the array. Actual pattern in the presence of ground may be found by multiplying this pattern by the ground-reflection factors given in Chapter Two.

frequency as a simple broadside array with 3/8-wave spacing.

An alternative method of feeding is shown in the small diagram in Fig. 4-30. In this case the elements and the phasing line must be adjusted exactly to an electrical half wavelength. The impedance at the feed point will be resistive and of the order of 2000 ohms.

**Checking Phasing**

In the antenna diagrams earlier in this chapter the relative direction of current flow in the various antenna elements and connecting lines was shown by arrows. In laying out any antenna system it is necessary to know that the phasing lines are properly connected; otherwise the antenna may have entirely different characteristics than anticipated. The phasing may be checked either on the basis of current direction or polarity of voltages. There are two rules to remember:

- 1) In every half-wave section of wire, starting from an open end, the current directions reverse. In terms of voltage, the polarity reverses at each half-wave point, starting from an open end.
- 2) Currents in transmission lines always must flow in opposite directions in adjacent wires. In terms of voltage, polarities always must be opposite.

Examples of the use of current direction and voltage polarity are given at A and B, respectively, in Fig. 4-33. The half-wave points in the system are marked by the small circles. When current in one section flows toward a circle, the current in the next section must also flow toward it, and vice versa. In the four-element antenna shown at A, the current in the upper right-hand element cannot flow toward the transmission line, because then the current in the right-hand section of the phasing line would have to flow upward and thus would be flowing in the same direction as the current in the left-hand wire. The phasing line would simply act like two wires in parallel in such a case.

C shows the effect of transposing the phasing line. This transposition reverses the direction of current flow in the lower pair of elements, as compared with A, and thus changes the array from a combination collinear and end-fire arrangement into a collinear-broadside array.

The drawing at D shows what happens when the transmission line is connected at the center of a section of phasing line. Viewed from the main transmission line the two parts of the phasing line are simply in parallel, so the half wavelength is measured from the antenna element along the upper section of phasing line and thence along the transmission line. The distance from the lower elements is measured in the same way. Obviously the two sections of phasing line should be the same length. If they are not, the current distribution becomes quite complicated; the element currents are neither in phase nor 180 degrees out of phase, and the elements at opposite ends of the lines do not receive the same power. To change the element current phasing at D into the phasing at A, simply transpose the wires in one section of the phasing line; this reverses the direction of current flow in the antenna elements connected to that section of phasing line.

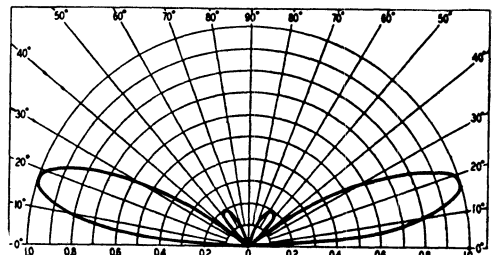
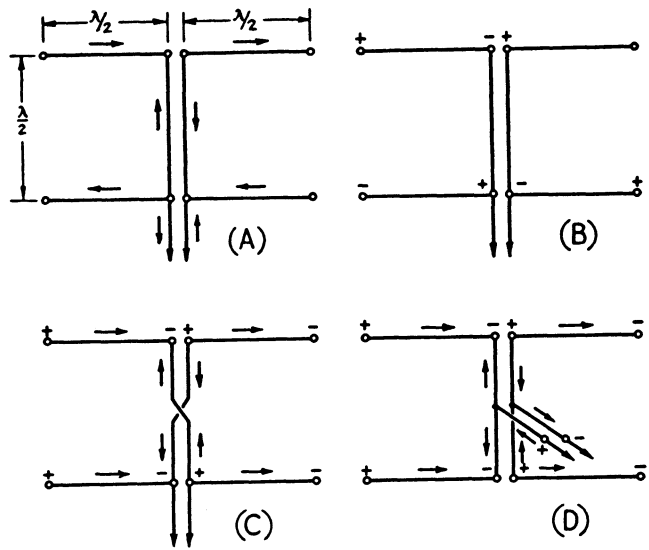

Fig. 4-32 - Vertical pattern of the four-element broadside antenna of Fig. 4-30, when mounted with the elements horizontal and the lower set 1/2 wavelength above ground. "Stacked" arrays of this type give best results when the lowest elements are at least 1/2 wavelength high. The gain is reduced and the wave angle raised if the lowest elements are close to ground.



Fig. 4-33 — Methods of checking the phase of currents in elements and phasing lines.



### PARASITIC ARRAYS

Multielement arrays containing parasitic elements are called “parasitic” arrays even though at least one and sometimes more than one of the elements is driven. A parasitic element obtains its power through electromagnetic coupling with a driven element, as contrasted with receiving it by direct connection to the power source. A parasitic array with linear (dipole-type) elements is fre-

quently called a “Yagi” or “Yagi-Uda” antenna, after the inventors.

As explained earlier in this chapter in the section on mutual impedance, the amplitude and phase of the current induced in an antenna element depend on its tuning and the spacing between it and the driven element to which it is coupled. The fact that the relative phases of the currents in driven and parasitic elements can be adjusted is very advantageous. For example, the spacing and tuning can be adjusted to approximate the conditions that exist when two driven elements 1/4 wavelength apart are operated with a phase difference of 90 degrees (which gives a unidirectional pattern as shown in Fig. 4-25). However, complete cancellation of radiation in the rear direction is not possible when a parasitic element is used. This is because it is usually not possible to make amplitude and phase *both* reach desired values simultaneously. Nevertheless, a properly designed parasitic array can be adjusted to have a large front-to-back ratio.

The substantially unidirectional characteristic and relatively simple electrical configuration of an array using parasitic elements make it especially useful for antenna systems that are to be rotated to aim the beam in any desired direction.

#### Reflectors and Directors

Although there are special cases where a parasitic array will have a bidirectional (but usually not symmetrical) pattern, in most applications the pattern tends to be unidirectional. A parasitic element is called a director when it makes the radiation maximum along the perpendicular line from the driven to the parasitic element, as shown at A in Fig. 4-34. When the maximum radiation is

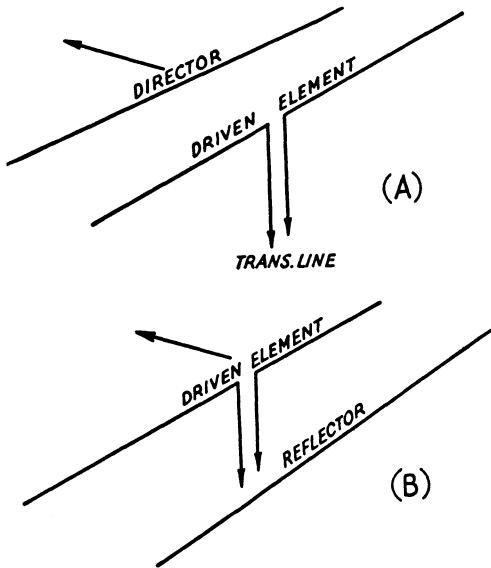

Fig. 4-34 — Antenna systems using a single parasitic element. In A the parasitic element acts as a director, in B as a reflector. The arrows show the direction in which maximum radiation takes place.

in the opposite direction — that is, from the parasitic element through the driven element as at B — the parasitic element is called a reflector.

Whether the parasitic element operates as a director or reflector is determined by the relative phases of the currents in the driven and parasitic elements. At the element spacings commonly used ( $1/4$  wavelength or less) the current in the parasitic element will be in the right phase to make the element act as a reflector when its tuning is adjusted to the low-frequency side of resonance (inductive reactance). The parasitic element will act as a director when its tuning is adjusted to the high-frequency side of resonance (capacitive reactance). The proper tuning is ordinarily accomplished by adjusting the lengths of the parasitic elements, but the elements can be “loaded” at the center with lumped inductance or capacitance to achieve the same purpose. If the parasitic element is self-resonant the element spacing determines whether it will act as a reflector or director.

### THE TWO-ELEMENT BEAM

The maximum gain theoretically obtainable with a single parasitic element, as a function of the spacing, is shown in Fig. 4-35 (from analysis by G. H. Brown). The two curves show the greatest gain to be expected when the element is tuned for optimum performance either as a director or reflector. This shift from director to reflector, with the corresponding shift in direction as shown in Fig. 4-34, is accomplished simply by tuning the parasitic element — usually, in practice, by changing its length.

With the parasitic element tuned to act as a director, maximum gain is secured when the spacing is approximately 0.1 wavelength. When the parasitic element is tuned to work as a reflector, the spacing that gives maximum gain is about 0.15 wavelength, with a fairly broad peak. The director will give slightly more gain than the reflector, but the difference is less than 1/2 dB.

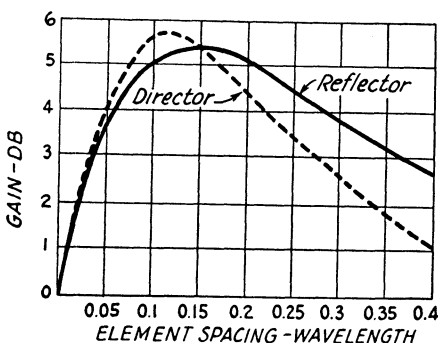

Fig. 4-35 — The maximum possible gain obtainable with a parasitic element over a half-wave antenna alone, assuming that the parasitic element tuning is adjusted for greatest gain at each spacing. These curves assume no ohmic losses in the elements. In practical antennas the gain is less, particularly at close spacings.

In only two cases are the gains shown in Fig. 4-35 secured when the parasitic element is self-resonant. These occur at 0.1- and 0.25-wavelength spacing, with the parasitic element acting as director and reflector, respectively. For reflector operation, it is necessary to tune the parasitic element to a lower frequency than resonance to secure maximum gain at all spacings less than 0.25 wavelength, while at greater spacings the reverse is true. The closer the spacing the greater the detuning required. On the other hand, the director must be detuned toward a higher frequency (that is, its length must be made less than the self-resonant length) at spacings greater than 0.1 wavelength in order to secure maximum gain. The amount of detuning necessary becomes greater as the spacing is increased. At less than 0.1-wavelength spacing the director must be tuned to a lower frequency than resonance to secure the maximum gains indicated by the curve. (Generally these requirements for maximum gain are not followed in practice for close-spaced directors or wide-spaced reflectors; instead, forward gain is sacrificed for a higher front-to-back ratio or greater bandwidth, as discussed in a later section.)

### Input Impedance

The radiation resistance at the center of the driven element varies as shown in Fig. 4-36 for the spacings and tuning conditions that give the gains indicated by the curves of Fig. 4-35. These values, especially in the vicinity of 0.1-wavelength spacing, are quite low. The curves coincide at 0.1 wavelength, both showing a value of 14 ohms.

The low radiation resistance at the spacings giving highest gain tends to reduce the radiation efficiency. This is because, with a fixed loss resistance, more of the power supplied to the antenna is lost in heat and less is radiated, as the radiation resistance approaches the loss resistance in magnitude.

The loss resistance can be decreased by using low-resistance conductors for the antenna elements. This means, principally large-diameter conductors, usually tubing of aluminum, copper, or copper-plated steel. Such conductors have mechanical advantages as well, in that it is relatively easy to provide adjustable sliding sections for changing length, while the fact that they can be largely self-supporting makes them well adapted for rotatable antenna construction. With half-inch or larger tubing the loss resistance in any two-element antenna should be small.

With low radiation resistance the standing waves of both current and voltage on the antenna reach considerably higher maximum values than is the case with a simple dipole. For this reason losses in insulators at the ends of the elements become more serious. The use of tubing rather than wire helps reduce the end voltage, and furthermore the tubing does not require support at the ends, thus eliminating the insulators.

The mutual impedance between two parallel antenna elements contains reactance as well as resistance, so that the presence of a director or reflector near the driven element affects not only

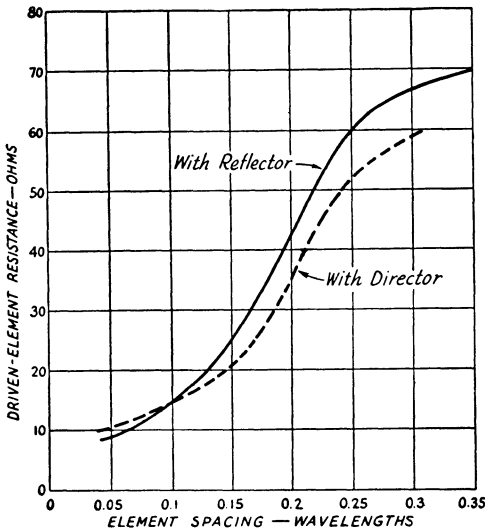

Fig. 4-36 — Radiation resistance at center of driven element as a function of element spacing, when the parasitic element is adjusted for the gains given in Fig. 4-35.

the radiation resistance of the driven element but also introduces a reactive component (assuming that the driven element length is such as to be resonant if the parasitic element were not there). In other words, the parasitic element detunes the driven element. The degree of detuning depends on the spacing and tuning of the parasitic element, and also on the length/diameter ratios of the elements.

With the parasitic element tuned for maximum gain, the effect of the coupled reactance is to make the driven element "look" more inductive with the parasitic element tuned as a reflector than it does when the parasitic element is tuned as a director. That is, the driven element should be slightly longer, if the parasitic element is a director, than when the parasitic element is a reflector. These remarks apply to spacings between about 0.1 and 0.25 wavelength, but are not necessarily true for other spacings.

**Self-Resonant Parasitic Elements**

The special case of the self-resonant parasitic element is of interest, since it gives a good idea of the performance as a whole of two-element systems, even though the results can be modified by detuning the parasitic element. Fig. 4-37 shows gain and radiation resistance as a function of the element spacing for this case. Relative field strength in the direction A of the small drawing is indicated by Curve A; similarly for Curve B. The front-to-back ratio at any spacing is the difference between the values given by curves A and B at that spacing. Whether the parasitic element is functioning principally as a director or reflector is determined by whether Curve A or Curve B is on top; it can be seen that the principal function shifts at

about 0.14-wavelength spacing. That is, at closer spacings the parasitic element is principally a director, while at greater spacings it is chiefly a reflector. At 0.14 wavelength the radiation is the same in both directions; in other words, the antenna is bidirectional with a theoretical gain of about 4 dB.

The front-to-back ratios that can be secured with the parasitic element self-resonant are not very great except in the case of extremely close spacings. Spacings of the order of .05 wavelength are not very practicable with outdoor construction since it is difficult to make the elements sufficiently stable mechanically. Ordinary practice is to use spacings of at least 0.1 wavelength and detune the parasitic element for greatest attenuation in the backward direction.

The radiation resistance increases rapidly for spacings greater than 0.15 wavelength, while the gain, with the parasitic element acting as a reflector, decreases quite slowly. If front-to-back ratio is not an important consideration, a spacing as great as 0.25 wavelength can be used without much reduction in gain. At this spacing the radiation resistance approaches that of a half-wave antenna alone. Spacings of this order are particularly suited to antennas using wire elements, such as multielement arrays consisting of combinations of colinear and broadside elements.

**Front-to-Back Ratio**

The tuning conditions that give maximum gain forward do not give maximum signal reduction, or attenuation, to the rear. It is necessary to sacrifice some gain to get the highest front-to-back ratio. The reduction in backward response is brought about by adjustment of the tuning or length of the parasitic element. With a reflector, the length must be made slightly greater than that which gives maximum gain, at spacings up to 0.25 wavelength. The director must be shortened somewhat to achieve the same end, with spacings of 0.1 wave-

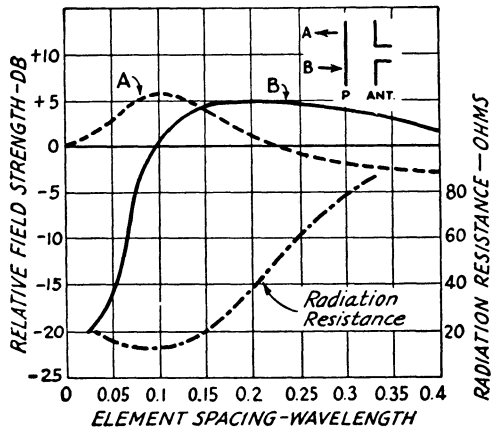

Fig. 4-37 — Theoretical gain of a two-element parasitic array over a half-wave dipole as a function of element spacing when the parasitic element is self-resonant.

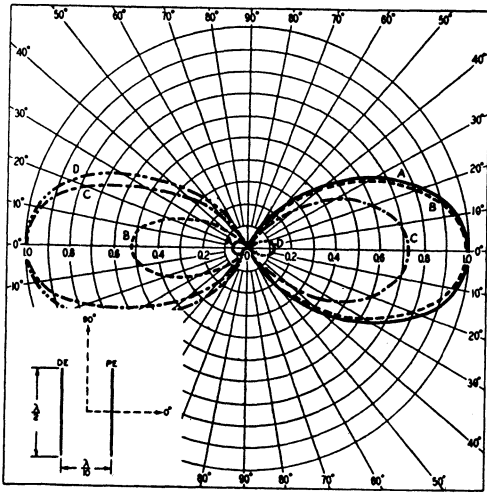

Fig. 4-38 — Experimentally determined horizontal directive patterns of horizontally polarized two-element parasitic arrays at a height of 1-1/4 wavelengths. These patterns are for a wave angle of 12 degrees. The curves represent the following conditions, approximately:

- A — Parasitic element tuned for maximum gain as a director.
- B — Parasitic element self-resonant.
- C — Parasitic element tuned for maximum gain as a reflector
- D — Parasitic element tuned for maximum front-to-back ratio as a reflector.

The spacing between elements is 0.1 wavelength. The patterns should not be compared for gain, since they are plotted on a relative basis to an arbitrarily chosen maximum of 1.0.

length and more. The tuning condition, or element length, which gives maximum attenuation to the rear is considerably more critical than that for maximum gain, so that a good front-to-back ratio can be secured without sacrificing more than a small part of the gain.

For the sake of good reception, general practice is to adjust for maximum front-to-back ratio rather than for maximum gain. Larger front-to-back ratios can be secured with the parasitic element operated as a director rather than as a reflector. With the optimum director spacing of 0.1 wavelength, the front-to-back ratio with the director tuning adjusted for maximum gain is only 5.5 dB (the back radiation is equal to that from the antenna alone). By proper director tuning, however, the ratio can be increased to 17 dB; the gain in the desired direction is in this case 4.5 dB, or 1 dB less than the maximum obtainable.

**Directional Patterns**

The directional patterns obtained with two-element arrays will vary considerably with the tuning and spacing of the parasitic element. Typical patterns are shown in Figs. 4-38 and 4-39, for four cases where the parasitic element tuning or

length is approximately adjusted for optimum gain as a director, for self-resonance, for optimum gain as a reflector, and for optimum front-to-back ratio as a reflector. Over this range of adjustment the width of the main beam does not change significantly. These patterns are based on experimental measurements by J. L. Gillson, W3GAU.

**Bandwidth**

The bandwidth of the antenna can be specified in various ways, such as the width of the band over which the gain is higher than some stated figure, the band over which at least a given front-to-back ratio is obtained, or the band over which the standing-wave ratio on the transmission line can be maintained below a chosen value. The latter is probably the most useful, since the SWR not only determines the percentage power loss in the transmission line but also affects the coupling between the transmitter and the line.

The bandwidth from this latter standpoint depends on the *Q* of the antenna (see Chapter Three). The *Q* of close-spaced parasitic arrays is quite high, with the result that the frequency range over which the SWR will stay below a specified maximum value is relatively narrow. The data in Table 4-I, for a driven element and close-spaced director, are from experimental measurements made by J. P. Shanklin. The antenna with .075-wavelength spacing will, through a suitable matching device, operate with an SWR of less than 3 to 1 over a band having a width equal to about 3 per cent of the center frequency (this corresponds to the width of the 14-MHz band for a 14-MHz antenna, for example) and maintain a front-to-back ratio of approximately 10 dB or better over this band. At greater element spacings than those

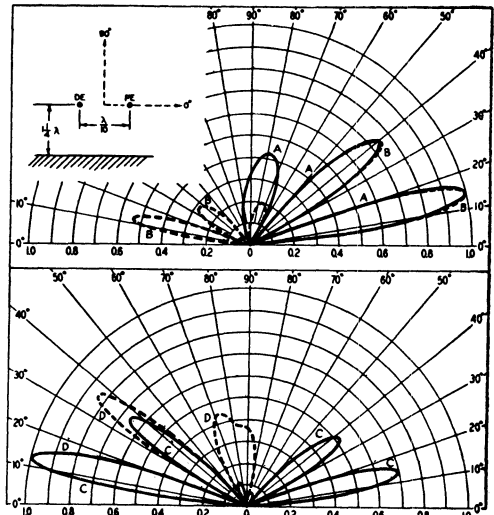

Fig. 4-39 — Vertical patterns of a horizontally polarized two-element array under the conditions given in Fig. 4-38. These patterns are in the vertical plane at right angles to the antenna elements.

TABLE 4-1

Feed Impedance and Front-to-Back Ratio of a Fed Dipole  
with One Director

Element Spacing	Fed Dipole Length	Director Length	Input Resistance at Band Center	$Q$	Front-to-Back Ratio at Band Center
0.050 $\lambda$	0.509 $\lambda$	0.484 $\lambda$	13.2 ohms	53.2	20.0 (26 dB)
0.075	0.504	0.476	24.4	29.4	8.3 (18 dB)
0.100	0.504	0.469	28.1	20.0	4.3 (12.7 dB)

shown in the table the  $Q$  is smaller and the bandwidth consequently greater, but the front-to-back ratio is smaller. This is to be expected from the trend shown by the curves of Fig. 4-37. The gain is practically constant at about 5 dB for all spacings shown in Table 4-1.

The same series of experimental measurements showed that with the parasitic element tuned as a reflector for maximum front-to-back ratio the optimum spacing was 0.2 wavelength. The maximum front-to-back ratio was determined to be 16 dB. In both the director and reflector cases the front-to-back ratio decreased rather rapidly as the operating frequency was moved away from the frequency for which the system was tuned. With the reflector at 0.2-wavelength spacing and tuned for maximum front-to-back ratio the input resistance was found to be 72 ohms and the  $Q$  of the antenna was 4.7.

The antenna elements used in these measurements had a length/diameter ratio of 330. A smaller length/diameter ratio will decrease the rate of reactance change with length and hence decrease the  $Q$ , while a larger ratio will increase the  $Q$ . The use of fairly thick elements is desirable when maximum bandwidth is sought.

### THE THREE-ELEMENT BEAM

It is readily possible to use more than one parasitic element in conjunction with a single driven element. With two parasitic elements the optimum gain and directivity result when one is used as a reflector and the second as a director. Such an antenna is shown in Fig. 4-40.

As the number of parasitic elements is increased, the problem of determining the optimum element spacings and lengths to meet given specifications — i.e., maximum gain, maximum front-to-back ratio, maximum bandwidth, and so on — becomes extremely tedious because of the large number of variables. In general, it can be said that when one of these quantities — gain, front-to-back ratio, or bandwidth — is maximized the other two cannot be. Also, if it is desired to design the antenna to have a specific input impedance for matching a transmission line, the other three cannot be maximized.

#### Power Gain

A theoretical investigation of the 3-element case (director, driven element and reflector) has

indicated a maximum gain of slightly more than 7 dB (Uda and Mushiaki). A number of experimental investigations has shown that the optimum spacing between the driven element and reflector is in the region of 0.15 to 0.25 wavelength, with 0.2 wavelength representing probably the best overall choice.

With 0.2-wavelength reflector spacing, Fig. 4-41 shows the variation in gain with director length, with the director also spaced 0.2 wavelength from the driven element, and Fig. 4-42 shows the gain variation with director spacing. (These curves are from work by Carl Greenblum.) It is obvious that the director spacing is not especially critical, and that the overall length of the array (boom length in the case of a rotatable antenna) can be anywhere between 0.35 and 0.45 wavelength with no appreciable difference in gain.

Wide spacing of both elements is desirable not only because it results in high gain but also because adjustment of tuning or element length is less critical and the input resistance of the driven element is higher than with close spacing. The latter feature improves the efficiency of the antenna and makes a greater bandwidth possible. However, a total antenna length, director to reflector, of more than 0.3 wavelength at frequencies of the order of 14 MHz introduces considerable difficulty from a constructional standpoint, so lengths of 0.25 to 0.3 wavelength are frequently used for this band, even though they are less than optimum.

In general, the gain of the antenna drops off less rapidly when the reflector length is increased beyond the optimum value than it does for a corresponding decrease below the optimum value. The opposite is true of a director, as shown by Fig. 4-41. It is therefore advisable to err, if necessary, on the long side for a reflector and on the short side for a director. This also tends to make the antenna performance less dependent on the exact frequency at which it is operated, because an

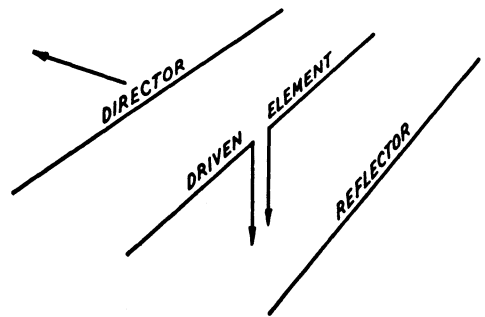

Fig. 4-40 — Antenna system using a driven element and two parasitic elements, one as a reflector and one as a director.

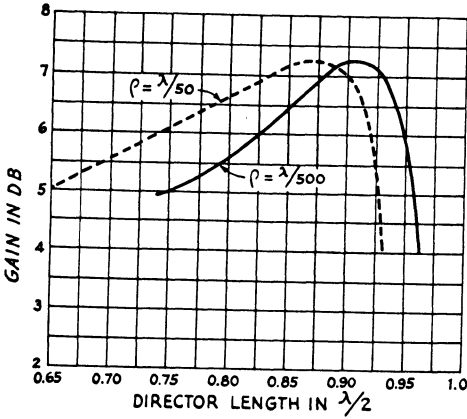

Fig. 4-41 — Gain of a 3-element Yagi over a dipole as a function of the director length for 0.2-wavelength spacing between driven element and director and the same spacing between driven element and reflector. These curves show how the element thickness affects the optimum length;  $\rho$  is the element radius expressed as a fraction of the wavelength.  $\lambda/500$  corresponds to an element radius of approximately 1/2 inch at 50 MHz. Where the fractional-wavelength radius is smaller, as on the lower frequencies, the optimum director length will be somewhat greater.

increase above the design frequency has the same effect as increasing the length of both parasitic elements, while a decrease in frequency has the same effect as shortening both elements. By making the director slightly short and the reflector slightly long, there will be a greater spread between the upper and lower frequencies at which the gain starts to show a rapid decrease.

**Input Impedance**

The radiation resistance as measured at the center of the driven element of a 3-element array can vary over a fairly wide range since it is a function of the spacing and tuning of the parasitic elements. There are, however, certain fairly well-defined trends. (1) The resistance tends to reach a minimum at the parasitic-element tuning condition that gives maximum gain, becoming larger as the element is detuned in either direction — that is, made longer or shorter. (2) The

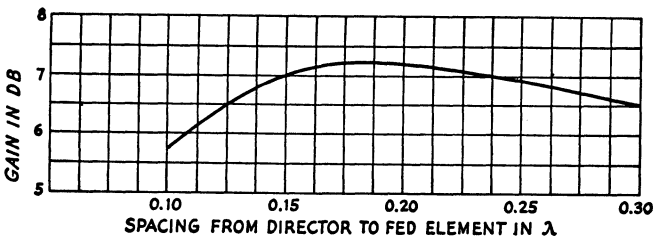

Fig. 4-42 — Gain of 3-element Yagi versus director spacing, the reflector spacing being fixed at 0.2 wavelength.

resistance tends to be lower the closer the spacing between the parasitic and driven elements. Values of the order of 10 ohms are typical with a 3-element beam having 0.1-wavelength director spacing, when the director length is adjusted for maximum gain. This can be raised considerably — to 50 ohms or more — by sufficient change in director length at a sacrifice of gain. The minimum value of resistance increases with increased director spacing, and is of the order of 30 ohms at a spacing of 0.25 wavelength.

As in the case of the two-element beam, tuning and spacing of the parasitic elements affect the reactance of the driven element; that is, a change in the spacing or length of the parasitic elements will tend to change the resonant frequency of the driven element. It is generally found, however, that the resonant length of the driven element with the parasitic elements properly tuned does not differ greatly from its resonant length with the parasitic elements removed. This is because the two parasitic elements reflect opposite kinds of reactance into the driven element and hence tend to cancel each other's effects in this respect.

Fig. 4-43 shows the results of experimental measurements made by J. P. Shanklin of the input resistance of 3-element arrays having an overall length (director to reflector) of 0.3 wavelength. The curves give resistance contours as a function of the spacing between the driven element and the reflector and the length of the director. So long as the reflector length was in the optimum region for good front-to-back ratio, as described in the next section, small changes in reflector length were found to have only a comparatively small effect on the input resistance. In using Fig. 4-43, it is to be understood that the spacing between the director and driven element is equal to the difference between 0.3 wavelength and the selected driven-element-to-reflector spacing, since the length of the array was held constant.

The elements used in obtaining the data in Fig. 4-43 had a length/diameter ratio of 330.

**Front-to-Back Ratio**

The element lengths and spacings are more critical when a high front-to-back ratio is the objective than when the antenna is designed for maximum gain. Some gain must be sacrificed for the sake of a good front-to-back ratio, just as in the case of the two-element array. In general, a high front-to-back ratio requires fairly close spacing between the director and driven element, but considerably larger spacings are optimum for the reflector.

The front-to-back ratio will change more rapidly than the gain when the operating frequency differs from that for which the antenna was adjusted.

The front-to-back ratio tends to decrease with increased spacing between the elements. However, with a director spacing of about 0.2 wavelength, it is possible to

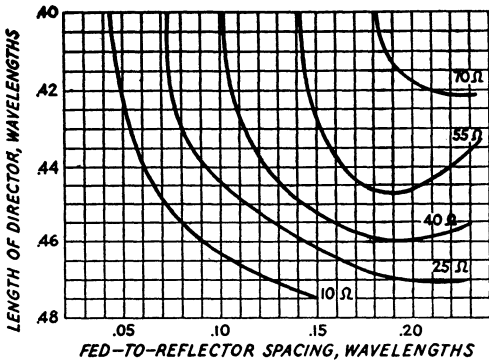

Fig. 4-43 — Resonant resistance of fed dipole in a 3-element parasitic antenna, overall length 0.3 wavelength.

secure a very good front-to-side ratio, which may be a useful feature in some locations. As in the case of front-to-back ratio, the reflector spacing has a considerably lesser effect.

**Bandwidth**

The bandwidth with respect to input impedance, as evidenced by the change in standing-wave ratio over a band of frequencies, will in general be smaller the smaller the input resistance. This in turn becomes smaller when the spacing between elements is decreased. Hence close spacings are usually associated with small bandwidths, especially when the element lengths are adjusted for maximum gain.

Fig. 4-44, also from data obtained in the experimental measurements of J. P. Shanklin, shows how the Q of a 3-element antenna having a total length of 0.3 wavelength varies as a function of spacing and director length. The data are for an element length/diameter ratio of 330, but should hold sufficiently well for ratios between 200 and 400. From the standpoint of impedance bandwidth, the upper right-hand region of the chart is best since this region is associated with low values of Q.

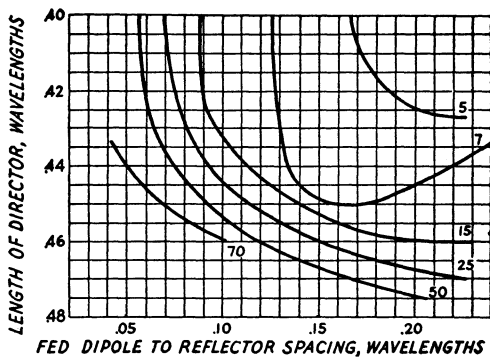

Fig. 4-44 — Q of input impedance of fed dipole in a 3-element parasitic antenna, overall length 0.3 wavelength.

In these measurements it was found that the length of the reflector for optimum front-to-back ratio did not vary over much of a range. In the "low-Q" region of Fig. 4-44 it was 0.51 wavelength, increasing to 0.525 wavelength in the "high-Q" region. The proper driven-element length was found to be 0.49 wavelength (at the center of the band) for all conditions.

Similar tests were made on antennas having overall lengths of 0.2 and 0.4 wavelength. The conclusion was (1) that the smaller length would give high front-to-back ratios but with high Q values and consequently small bandwidth; (2) with 0.4-wavelength overall the Q values were low enough for good bandwidth but the front-to-back ratio was smaller.

The Q values given by the chart can be used as described in Chapter Three to find the bandwidth over which the SWR will not exceed a specified value.

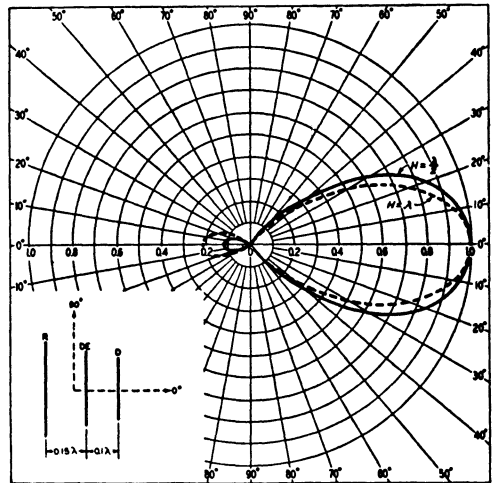

Fig. 4-45 — Measured radiation patterns of a horizontally polarized 3-element array having the director 0.1 wavelength and the reflector 0.15 wavelength from the driven element. Element tuning was adjusted for maximum gain. These "horizontal" patterns are for the wave angles at which the lowest lobe (Fig. 4-46) has its maximum. The wave angles are 28 degrees at a height of 1/2 wavelength and 12 degrees at a height of 1 wavelength.

The low values of radiation resistance are accompanied by a high degree of selectivity in the antenna; that is, its impedance is constant over only a small frequency range. These changes in impedance make it troublesome to couple power from the transmitter to the line. Such difficulties can be reduced by using wider spacing — in particular, using spacings of the order of 0.2 wavelength or more.

**Directive Patterns**

The directive patterns of Figs. 4-45 to 4-48 inclusive are, like those of Figs. 4-38 and 4-39

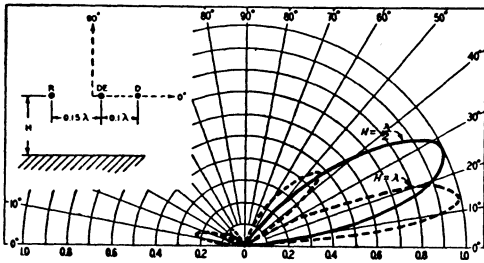

Fig. 4-46 — Vertical patterns of the antenna of Fig. 4-45 in the vertical plane at right angles to the direction of the antenna elements.

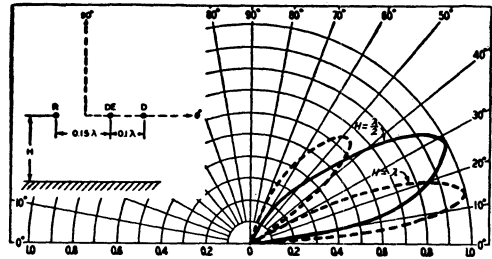

Fig. 4-48 — Vertical patterns of the antenna of Fig. 4-47 in the vertical plane at right angles to the direction of the antenna elements.

based on experimental measurements made by W3GAU at vhf. They show that the beam is somewhat sharper, as is to be expected, when the parasitic-element tuning is adjusted for maximum gain. Increasing the height of the antenna will of course lower the wave angle since the shape and amplitude of the vertical lobes are determined by the ground-reflection factors given in Chapter Two as well as by the free-space pattern of the antenna itself.

**FOUR-ELEMENT ARRAYS**

Parasitic arrays having a driven element and three parasitic elements — reflector and two directors — are frequently used at the higher frequencies, 28 MHz and up. This type of antenna is shown in Fig. 4-49.

Close spacing is undesirable in a four-element antenna because of the low radiation resistance. An optimum design, based on an experimental deter-

mination at 50 MHz, uses the following spacings:

- Driven element to reflector — 0.2 wavelength
- Driven element to first director — 0.2 wavelength
- First director to second director — 0.25 wavelength

Using a length/diameter ratio of about 100 for the elements, the element lengths for maximum gain were found to be

- Reflector — 0.51 wavelength
- Driven element — 0.47 wavelength
- First director — 0.45 wavelength
- Second director — 0.44 wavelength

The input resistance with the above spacings and dimensions was of the order of 30 ohms and the antenna gave useful gain over a total bandwidth equal to about 4 percent of the center frequency.

**LONG YAGIS**

Parasitic arrays are not limited as to the number of elements that can be used, although it is hardly practical to use more than four at frequencies below 30 MHz. However, on the vhf bands an array that is long in terms of wavelength is often of practicable physical size. Several independent investigations of the properties of multielement Yagi antennas have shown that in a general way the gain of the antenna expressed as a power ratio is proportional to the length of the array, provided the number, lengths, and spacings of the elements are properly chosen.

The results of one such study (by Carl Greenblum) are shown in terms of the number of elements in the antenna in Figs. 4-50 and 4-51. In every case the antenna consists of a driven element, one reflector, and a series of directors properly spaced and tuned. Thus if the antenna is to have a gain of 12 dB, Fig. 4-50 shows that 8 elements — driven, reflector, and six directors — will be required, and Fig. 4-51 shows that for such an 8-element antenna the array length required is 1.75 wavelength.

Table 4-II shows the optimum element spacings determined from the Greenblum investigations. There is a fair amount of latitude in the placement of the elements along the length of the array, although the optimum tuning of the element will vary somewhat with the exact spacing chosen. Within the spacing ranges shown, the gain will not

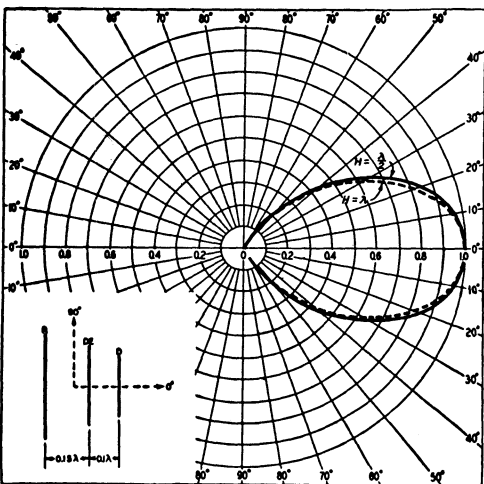

Fig. 4-47 — Measured radiation patterns of a horizontally polarized 3-element parasitic array having the director 0.1 wavelength from the driven element and the reflector 0.15 wavelength from the driven element. Element tuning was adjusted for maximum front-to-back ratio. Heights and wave angles are same as in Fig. 4-45.



**TABLE 4-II**  
Optimum Element Spacings for Multielement Yagi Arrays

No. Elements	R-DE	DE-D <sub>1</sub>	D <sub>1</sub> -D <sub>2</sub>	D <sub>2</sub> -D <sub>3</sub>	D <sub>3</sub> -D <sub>4</sub>	D <sub>4</sub> -D <sub>5</sub>	D <sub>5</sub> -D <sub>6</sub>
2	0.15λ-0.2λ						
2		0.07λ-0.11λ					
3	0.16 -0.23	0.16 -0.19					
4	0.18 -0.22	0.13 -0.17	0.14λ-0.18λ				
5	0.18 -0.22	0.14 -0.17	0.15 -0.20	0.17λ-0.23λ			
6	0.16 -0.20	0.14 -0.17	0.16 -0.25	0.22 -0.30	0.25λ-0.32λ		
8	0.16 -0.20	0.14 -0.16	0.18 -0.25	0.25 -0.35	0.27 -0.32	0.27λ-0.33λ	0.30λ-0.40λ
8 to N	0.16 -0.20	0.14 -0.16	0.18 -0.25	0.25 -0.35	0.27 -0.32	0.27 -0.33	0.35 -0.42

DE - Driven Element; R - Reflector; D - Director; N - any number; director spacings beyond D<sub>6</sub> should be 0.35-0.42λ.

vary more than 1 dB provided the director lengths are suitably adjusted.

The optimum director lengths are in general greater, the closer the particular director is to the driven element, but the length does not uniformly decrease with increasing distance from the driven element. Fig 4-52 shows the experimentally deter-

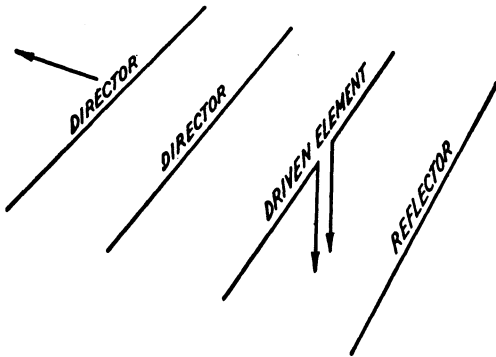

Fig. 4-49 - A four-element antenna system, using two directors and one reflector in conjunction with a driven element.

mined lengths for various element diameters, based on cylindrical elements supported by mounting through a cylindrical metal boom two or three times the element diameter. The curves probably would not be useful for other shapes.

In another study of long Yagi antennas at vhf, J. A. Kmosko, W2NLY, and H. G. Johnson, W6QKI, reached essentially the same general conclusions concerning the relationship between overall antenna length and power gain, although their gain figures differ from those of Greenblum. The comparison is shown in Fig. 4-53. The Kmosko-Johnson results are based on a somewhat different element spacing and a construction in which thin director elements are supported above the metal boom rather than running through it. In their optimum design the first director is spaced 0.1 wavelength from the driven element. The next two directors are slightly over 0.1 wavelength apart, the fourth director is approximately 0.2 wavelength from the third, and succeeding directors are spaced 0.4 wavelength apart. The Kmosko-Johnson figures are based on a simplified method of computing gain from the beamwidth of the antenna pattern, the beamwidths having been measured experimentally. The Greenblum data is from experimental measurement of gain.

Experimental gain figures based on measurements made at 3.3-centimeter wavelength by H. W. Ehrenspeck and H. Poehler, shown by a third curve in Fig. 4-53, indicate lower gain for a given antenna length but confirm the gain-vs.-length trend. These measurements were made over a large ground plane using elements of the order of one-quarter wavelength high. The general conclusions of this study were (1) that the reflector spacing and tuning is independent of the other antenna dimensions, the optimum fed-element to reflector spacing being in

Fig. 4-50 - Gain in dB over a half-wave dipole vs. the number of elements of the Yagi array, assuming the array length is as given in Fig. 4-51.

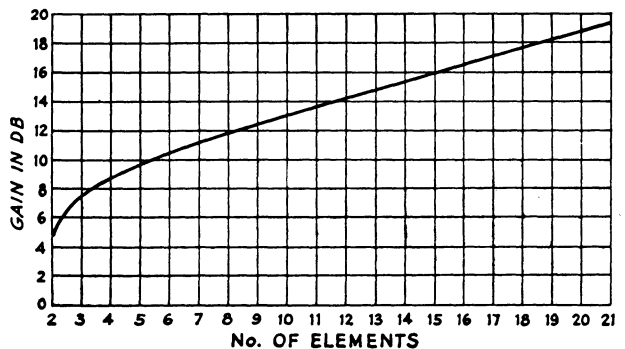

Fig. 4-51 — Optimum length of Yagi antenna as a function of number of elements.

the neighborhood of 0.25 wavelength but not critical; (2) for a given antenna length the gain is practically independent of the number of directors provided the director-to-director spacing does not exceed 0.4 wavelength; (3) that the optimum director tuning differs with different director spacings but that for constant spacings all directors can be similarly tuned; and (4) a slight improvement in gain results from using an extra director spaced about 0.1 wavelength from the driven element.

The agreement between these three sets of measurements is not as close as might be wished, which simply confirms the difficulty of determining optimum design where a multiplicity of elements is used, and of measuring gain with a degree of accuracy that will permit reconciliation of the results obtained by various observers. There is, however, agreement on the general principle that length is of greater importance than the number of elements, within the limit of a maximum element spacing of 0.4 wavelength.

It is an interesting fact that the feed-point impedance and bandwidth of long Yagis depends almost entirely on the two or three parasitic elements closest to the driven element, presumably because those farther from the driven element are relatively loosely coupled to it. In this respect, therefore, the information already given in connection with three-element arrays is quite applicable.

**STACKED YAGIS**

Parasitic arrays can be stacked either in broadside or collinear fashion for additional directivity

and gain. The increase in gain that can be realized is dependent on the spacing between the individual arrays. It is assumed, of course, that all the individual arrays making up the stacked system are identical, and that in the case of broadside stacking the corresponding elements are parallel and lie in planes perpendicular to the axis of the individual arrays. In collinear stacking, it is assumed that the corresponding elements are collinear and all elements of the individual arrays lie in the same plane. In both cases the driven elements must be fed in phase.

The decrease in beamwidth of the main radiation lobe that accompanies stacking is, in the general case, accompanied by a splitting off of one or more sets of side lobes. These will have an amplitude depending on the shape of the directive pattern of the unit array, the number of unit arrays, and their spacing. An optimum spacing is one which gives as much gain as possible on the condition that these side lobes do not exceed some specified amplitude relative to the main lobe. Fig. 4-54 shows the optimum spacings for three such

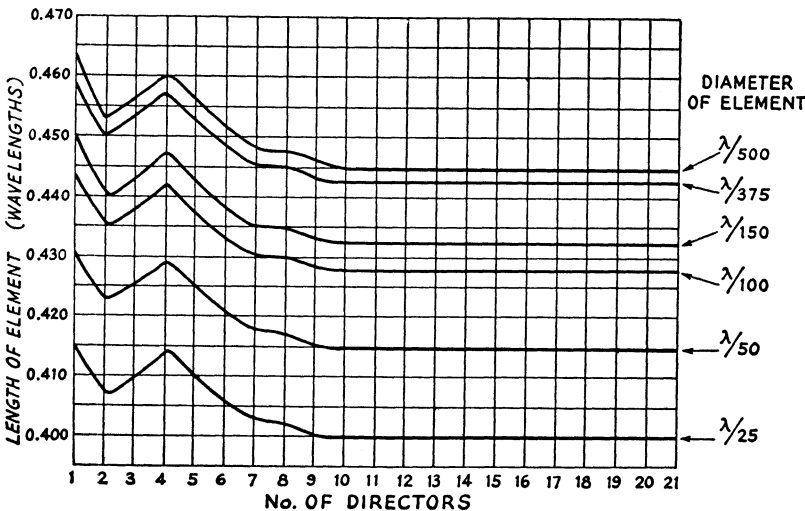
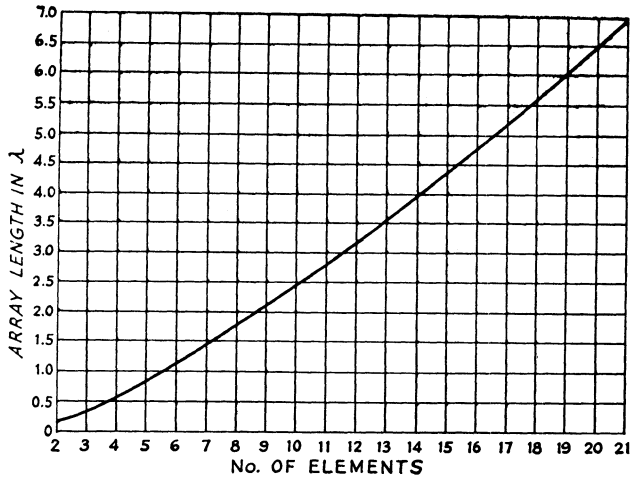

Fig. 4-52 — Length of director vs. its position in the array, for various element thicknesses.

conditions (no side lobes, side lobes down 10 dB, and side lobes down 20 dB) as a function of the half-power beamwidth of the unit array, from calculations by H. W. Kaspar, K2GAL. Maximum gain occurs when the side lobes are approximately 10 dB down, as indicated in the figure.

A single 3-element array will have a half-power beamwidth (free space) of approximately 75 degrees, and from Fig. 4-54 it can be determined that the optimum spacing for maximum gain will be slightly over 3/4 wavelength. Measurements by Greenblum have shown that the stacking gain that can be realized with two such Yagi antennas is approximately 3 dB, remaining practically constant at spacings from 3/4 to 2 wavelengths, but decreasing rapidly at spacings less than 3/4 wavelength. With spacings less than about 1/2 wavelength stacking does not give enough gain to make the construction of a stacked array worthwhile.

If reduction of side-lobe amplitude is the principal consideration rather than gain, smaller spacings are optimum, as shown by the curves. A similar set of curves for four stacked unit arrays is given in Fig. 4-55.

The spacings in Figs. 4-54 and 4-55 are measured between the array centers. When the unit arrays are stacked in a collinear arrangement, a spacing of less than 1/2 wavelength is physically impossible with full-size elements, since at 1/2-wavelength spacing the ends of the collinear elements will be practically touching.

**FEEDING AND ADJUSTMENT**

The problems of matching and adjusting parasitic arrays for maximum performance are the same in principle as with other antenna systems. Adjustment of element lengths for optimum performance usually necessitates measurements of relative field strength. However, the experience of a great many amateurs who have followed the rather laborious procedure (adjusting each element a little at a time, and measuring the relative field after each such change) has accumulated a large amount of data on optimum lengths. Depending on the objective in designing the antenna — i.e., maximum gain, maximum front-to-back ratio, etc. — it is possible to predetermine the actual element lengths for a given center frequency and thus avoid the necessity for such adjustments. Charts giving proper element lengths for 3-element beams are shown in the chapter on 14-, 21-, and 28-MHz antennas for the maximum-gain condition, and data for maximum front-to-back ratio were given earlier in this chapter. The principal adjustment that actually needs to be made is to match the antenna to the transmission line so the standing-wave ratio on the latter is minimized.

Fig.4-54 — Optimum stacking spacing for two-unit arrays. The spacing for no side lobes, especially for small beamwidths, may result in almost no gain improvement with stacking.

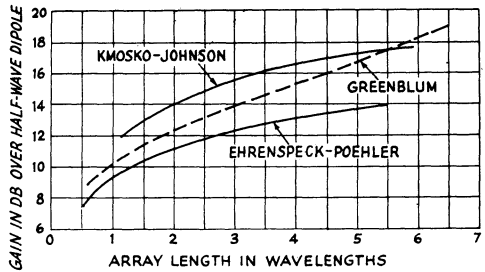
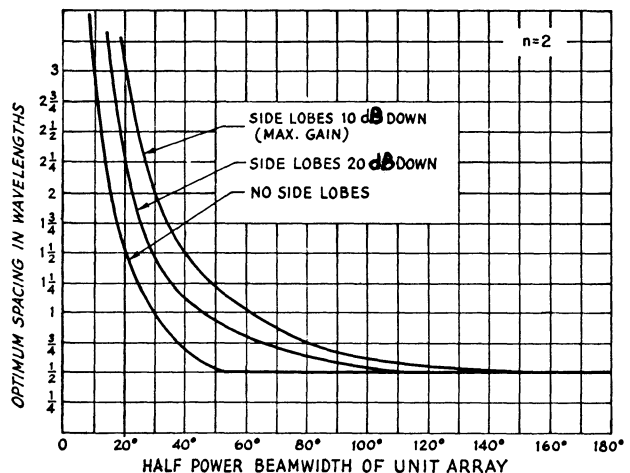

Fig. 4-53 — Gain of long Yagi antennas as a function of overall length. The antenna consists of a driven element, a single reflector spaced approximately one-fourth wavelength from the driven element, and a series of directors spaced as described in the text. The three curves represent the results of three independent studies.

**Methods of Feed**

The driven element in a parasitic array is a load for the transmission line in the same way that a driven element in any antenna system is such a load. It differs from the load presented by a simple dipole only in that the resistance may be quite low, especially if close spacings are used between elements, and the rate of change of reactance as the operating frequency is moved away from the design frequency may be greater. With low input resistance, a fairly large impedance step-up is required for matching practicable lines, and the amount of mismatch will increase more rapidly than with a simple dipole when the applied frequency is varied from that at which the line is matched.

Practically any of the matching systems detailed in Chapter Three are applicable. For exam-



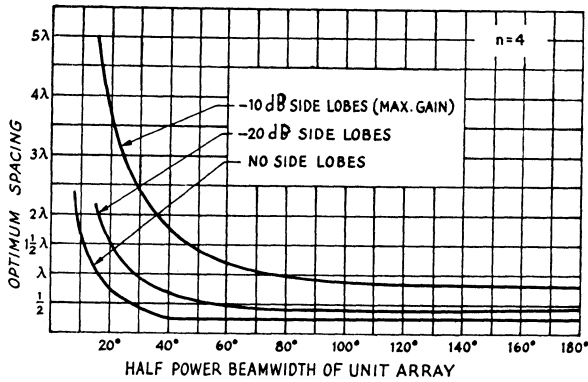

Fig. 4-55 — Optimum stacking spacing for four-unit arrays.

ple, an open quarter-wave matching section can be used if the transmission line is to be 300- to 600-ohm parallel-conductor line. The quarter-wave transformer (Q) method also can be used, with 75-ohm Twin-Lead for the transformer. This particular value of  $Z_0$  will match a driven element having a resistive impedance of 9 to 10 ohms to a 600-ohm open-wire line, and will result in only a 2-to-1 mismatch if the driven-element impedance is as low as 4 or 5 ohms or as high as 18 to 20 ohms. The loss in a quarter-wave section of 75-ohm transmitting-type Twin-Lead, even though the SWR in the matching transformer is rather high, will not be of any real consequence. Alternatively, the matching transformer may be made of 50- or 75-ohm coaxial cable. However, in such case some method of line balancing (such as those described in Chapter Three under *baluns*) should be used. The delta match may also be used.

The folded dipole used as the driven element also furnishes a useful method of transforming a low antenna resistance to a value suitable for matching a transmission line. Design details are given in Chapter Three.

The choice of a matching system is affected by constructional considerations, since parasitic arrays are usually built to be rotated in operation. The T match and gamma match are favorites with many amateurs because they fit in well, constructionally, when the driven element is made of tubing. Another matching system suitable for continuously rotatable antennas uses two large inductively coupled loops, one fixed and one rotatable. Open-wire line is preferred for such coupling, however, so this method is seldom used these days. Because of the attendant problems with installation of open-wire lines, most amateurs prefer coaxial lines for carrying rf power up a tower or other support and use rotators with mechanical stops to avoid entangling the feed line around the tower.

#### Broadening the Response

It has already been pointed out that the tuning conditions giving maximum gain with parasitic elements are not highly critical. However the

varying amounts of reactance coupled into the driven element, as well as the fact that the radiation resistance at the center of the driven element is often very low, cause the impedance to change rapidly when the applied frequency is varied above or below the design frequency.

This impedance change can be made less rapid by using fairly wide spacing between elements, as already mentioned. It is also beneficial to use elements having a fairly large ratio of diameter to length because, as explained in Chapter Two, the impedance change with frequency is reduced when the antenna conductor has a large diameter.

The use of a folded-dipole driven element is beneficial in broadening the frequency characteristic of the antenna because of the smaller effective length/diameter ratio that results from using two or more conductors instead of one.

#### Adjusting Parasitic Arrays

There are two separate processes in adjusting an array with parasitic elements. One is the determination of the optimum element lengths, depending on whether maximum gain or maximum front-to-back ratio is desired. The other is matching the antenna to the transmission line. The second is usually dependent on the first, and the results observed on adjusting the element tuning may well be meaningless unless the line is equally well matched under all tuning conditions.

As stated earlier, the element tuning for maximum gain is not excessively critical, and the dimensions given by the following formulas have been found to work well in practice for 3-element antennas:

$$\text{Driven element: Length (ft)} = \frac{475}{f \text{ (MHz)}}$$

$$\text{Director: Length (ft)} = \frac{455}{f \text{ (MHz)}}$$

$$\text{Reflector: Length (ft)} = \frac{500}{f \text{ (MHz)}}$$

These are average lengths determined experimentally for elements having a length/diameter ratio of 200 to 400, and with element spacings from 0.1 to 0.2 wavelength.

Many amateurs have found that very satisfactory results are secured simply by cutting the elements to the lengths given by these formulas. It has been a rather common experience that, after a considerable amount of time has been spent in trying all possible adjustments, the dimensions finally determined to be optimum are very close to those given by the formulas above or the charts contained in Chapter Nine (the difference between the charts and the formulas above amount to only about one percent in most cases), and the actual difference in gain is negligible. It appears safe to say, therefore, that in the average case there is probably little to be realized, in the way of increased gain, by spending much time in adjusting

element lengths. The front-to-back ratio can often be improved, however, since it depends much more on the exact element tuning. In general, the reflector tuning is the more critical.

If the array is put up by formula, the only adjustment that need be made is to match the driven element to the transmission line. The adjustment procedure for each type of matching arrangement is described in Chapter Three.

**Test Setup**

The only practicable method of adjusting parasitic element lengths for best performance is to measure the field strength from the antenna as adjustments are made. Measurements on a relative basis are entirely satisfactory for the purpose of determining the operating conditions that result in the maximum output or greatest front-to-back ratio. For this purpose the measuring equipment does not need to be calibrated; the only requirement is that it indicate whether the signal is stronger or weaker.

If the help of a nearby amateur owning a receiver with an S meter can be enlisted, the S-meter indications can be used to indicate the relative field strength. A few precautions must be taken if this method is to be reliable. The receiving antenna must have the same polarization as the transmitting antenna under test (that is usually horizontal) and should be reasonably high above its surroundings. The receiving system should be checked for pickup on the transmission line to make sure that the indications given by the receiver are caused entirely by energy picked up by the receiving antenna itself. This can be checked by temporarily disconnecting the line from the antenna (but leaving it in place) and observing the signal strength on the S meter. If the reading is not several S units below the reading with the antenna connected, the readings cannot be relied upon when adjusting the transmitting antenna for maximum gain. In checking the front-to-back ratio, the stray pickup at the receiving installation must be well below the smallest signal received via the antenna, if the adjustments are to mean anything at all.

Another method of checking field strength is to use a field-strength indicator of the diode-detector type. The preferable method of using such an indicator is to connect it to a dipole antenna mounted some distance away and at a height at least equal to that of the transmitting antenna. There should be no obstructions between the two antennas, and both should have the same polarization. The receiving dipole need not be a half wave long, although that length is desirable because it will increase the ratio of energy picked up on the antenna to energy picked up by stray means. To prevent coupling effects the distance between the two antennas should be at least three wavelengths. At shorter distances the mutual impedance may be large enough to cause the receiving antenna to tend to become part of the transmitting system, which can lead to false results. A recommended type of indicating system is shown in Fig. 4-56. The transmission line should drop vertically down to

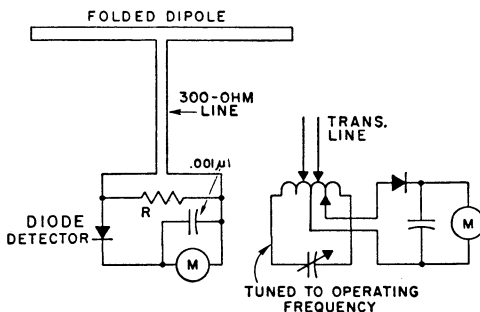

Fig. 4-56 — Field-strength measurement setup. The folded dipole should be at least as high as the antenna under test and should be three or more wavelengths away. *R* should be a 300-ohm composition resistor to provide a proper load for the line, so that a line of any desired length can be used. If the sensitivity is not high enough with this arrangement the alternative connections at the right will result in increased meter readings. The taps are adjusted for maximum reading, keeping the transmission-line taps spaced equally on either side of the coil center tap. The indicating meter, *M* may be either a microammeter or 0–1 milliammeter.

the indicator, to avoid stray pickup. This pickup can be checked as described in the preceding paragraph. If the distance between the two antennas is such that greater sensitivity is needed a reflector may be placed 1/4 wavelength behind the receiving dipole.

**Adjustment Procedure**

It is advisable first to set the element lengths to those given by the formulas and then match the driven element to the transmission line obtaining as low an SWR as possible. In subsequent adjustments a close watch should be kept on the SWR and the transmitter power input should be maintained at exactly the same figure throughout. If the SWR changes enough to affect the coupling at the transmitter when an adjustment is made, but not enough to raise the line loss significantly (see Fig. 3-23), readjust the coupling to bring the input back to the same value. If the line loss increases more than a fraction of a decibel, *rematch at the driven element*. If this is not done, the results may be entirely misleading; it is absolutely necessary to maintain constant power input to the driven element if adjustment of directors or reflectors is to give meaningful results.

The experience of most amateurs in adjusting parasitic arrays indicates that there is not a great deal of preference in the order in which elements are tuned, but that there is slightly less interaction if the director is first adjusted to give maximum gain and the reflector is then adjusted to give either maximum gain or maximum front-to-back ratio, whichever is desired. After the second parasitic element has been adjusted, go back and check the tuning of the first to make sure that it has not been thrown out of adjustment by the mutual coupling. If there are three parasitic elements, the other two

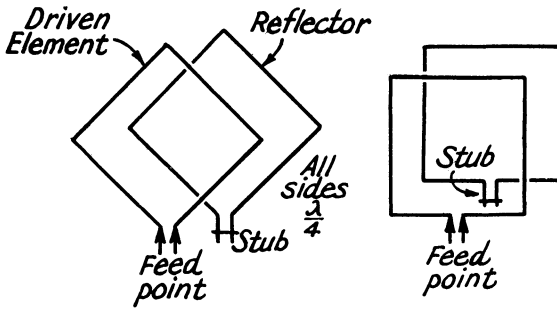

Fig. 4-57 — The basic quad antenna, with driven loop and reflector loop. The loops are electrically one wavelength in circumference ( $1/4$  wavelength on a side). Both configurations shown give horizontal polarization; for vertical polarization, the driven element should be fed at one of the side corners in the arrangement at the left, or at the center of a vertical side in the "square" quad at the right.

should be checked each time an appreciable change is made in one. The actual lengths should not be very far from those given by the formulas when the optimum settings are finally determined. As already pointed out, the reflector length may be somewhat greater when adjusted to give maximum front-to-back ratio.

Radiation from the transmission line must be eliminated, or at least reduced to a very low value compared with the radiation from the antenna itself, if errors are to be avoided. Conditions are usually favorable to low line radiation in horizontally polarized rotatable parasitic arrays because the line is usually symmetrical with respect to the antenna and is brought away perpendicular to it, at least for a half wavelength or so. Nevertheless the line radiation can be appreciable unless the line is detuned as described in Chapter Three. With coaxial line some method of line balancing at the antenna always should be incorporated to avoid "skewing" the beam pattern or lowering the front-to-back ratio.

After arriving at the optimum adjustments at the frequency for which the antenna was designed, the performance should be checked over a frequency range either side of the design frequency to observe the sharpness of response. If the field strength falls off rapidly with frequency, it may be desirable to shorten the director a bit to increase the gain at frequencies above resonance and lengthen the reflector slightly to increase it at frequencies below resonance. Do not confuse the change in SWR with the change in antenna gain. The antenna itself may give good gain over a considerable frequency range, but the SWR may vary between wide limits in this range. To check the *antenna* behavior, keep the power input to the transmission line constant and rematch the driven element to the line, as suggested above, whenever the line losses increase appreciably. If such rematching is found necessary over the band of frequencies to be used, it may be advisable to retune the system to give a higher input resistance and thus decrease the

selectivity, even though some gain is sacrificed in so doing.

#### Adjustment by Reception

As an alternative to applying power to the array and checking the field strength, it is possible to adjust the array by measuring received signal strength. It is impracticable to do this on distant signals because of fading. The most reliable method is to erect a temporary antenna of the type recommended for field-strength measurements (Fig. 4-56) and excite it from a low-power oscillator. The same precautions with respect to distance between the two antennas apply.

In this method, as in the one where the transmitting antenna is excited, it is necessary to minimize line radiation and pickup if the results are to be reliable. The same tests may be applied. However, it is less easy to keep the SWR under control. In the receiving case the SWR on the transmission line depends on the load presented by the *receiver* to the line. Under most conditions the SWR will be reasonably constant over an amateur band, although its value may not be known. However, the energy transfer from the antenna to the line depends on the mismatch between the driven element and the line. There is no convenient way to check this in the receiving case. About all that can be done is to apply power to the array after a set of tuning conditions has been reached, and then rematch at the driven element if necessary. After rematching, the measurement will have to be repeated. Thus double checking is necessary if the results are to be comparable with those obtained by the field-strength method.

### THE QUAD ANTENNA

In this chapter it has been assumed that the various antenna arrays have been assemblies of linear half-wave (or approximately half-wave) dipole elements. However, other element forms may be used according to the same basic principles. For example, loops of various types may be combined into directive arrays. A popular type of parasitic array using loops is the quad antenna, in which loops having a perimeter of one wavelength are used in much the same way as dipole elements in the Yagi antenna.

The quad antenna was originally designed by Moore, W9LZX, in the late 1940s. Since its inception there has been extensive controversy whether the quad is a better performer than a Yagi. This argument continues, but over the years several facts have become apparent. For example, Lindsay (W7ZQ, ex-WØHTH) has made many comparisons between quads and Yagis. His data, Fig. 4-58, shows that the quad has a gain of approximately 2 decibels over a Yagi for the same array length. Another argument that has existed is that for a given array height, the quad has a lower angle of radiation than a Yagi. Even among authorities there is disagreement on this point. However, as Fig. 4-59 shows, the *H*-plane pattern of a quad is slightly greater than a Yagi at the half-power points. This means that the quad covers a wider area in the vertical plane.

The full-wave loop has been discussed in Chapter Two. Two such loops, one as a driven element and one as a reflector, are shown in Fig. 4-57. This is the original version of the quad; in subsequent development, loops tuned as directors have been added in front of the driven element. The square loops may be mounted either with the corners lying on horizontal and vertical lines, as shown at the left, or with two sides horizontal and two vertical (right). The feed points shown for these two cases will result in horizontal polarization, which is commonly used.

The parasitic element is tuned in much the same way as the parasitic element in a Yagi antenna. That is, the parasitic loop is tuned to a lower frequency than the operating frequency when the element is to act as a reflector, and to a higher frequency when it acts as a director. Fig. 4-57 shows the parasitic element with an adjustable tuning stub, a convenient method of tuning since the resonant frequency can be changed simply by changing the position of the shorting bar on the stub. In practice, it has been found that the length around the loop should be approximately 3 percent greater than the self-resonant length if the element is a reflector, and about 3 percent shorter than the self-resonant length if the parasitic element is a director. Approximate formulas for the loop lengths in feet are

$$\text{Driven element} = \frac{1005}{f \text{ (MHz)}}$$

$$\text{Reflector} = \frac{1030}{f \text{ (MHz)}}$$

$$\text{Director} = \frac{975}{f \text{ (MHz)}}$$

for quad antennas intended for operation below 30 MHz. At vhf, where the ratio of loop circumference to conductor diameter is usually relatively small, the circumference must be increased in comparison to the wavelength. For example, a one-wavelength loop constructed of quarter-inch tubing for 144 MHz should have a circumference

about 4.5 percent greater than the wavelength in free space, as compared to the approximately 2 percent increase in the formula above for the driven element.

In any case, on-the-ground adjustment is required if optimum results are to be secured, especially with respect to front-to-back ratio. The method of adjustment parallels that outlined previously for the Yagi antenna.

Element spacings of the order of 0.14 to 0.2 wavelength are generally used, the smaller spacings being employed in antennas having more than two elements, where the structural support for elements with larger spacings tends to become difficult. The feed-point impedances of antennas having element spacings of this order have been found to be in the 40- to 60-ohm range, so the driven element can be fed through coaxial cable with only a small mismatch. For spacings of the order of 0.25 wavelength (physically feasible for two elements, or for several elements at 28 MHz) the impedance more closely approximates the impedance of a driven loop alone (see Chapter Two) – that is, 80 or 90 ohms.

The feed methods described in Chapter Three can be used, just as in the case of the Yagi.

#### Directive Patterns and Gain

The small gain of a one-wavelength loop over a half-wave dipole (see Chapter Two) carries over into arrays of loops. That is, if a quad parasitic array and a Yagi having the same overall length (boom length) are compared the quad will have approximately 2 dB greater gain than the Yagi, as mentioned earlier. This assumes that both antennas have the optimum number of elements for the antenna length; the number of elements is not necessarily the same in both when the antennas are long. Fig. 4-58 shows the results of comparative experimental measurements on the two antenna types at 440 MHz, made by Lindsay (from *QST*, May, 1968). The curves show directivity vs. array length, which may be read as feet instead of centimeters if the frequency is taken as 14 MHz instead of 440 MHz. Gain over a half-wave dipole (assuming negligible ohmic loss) can be found by

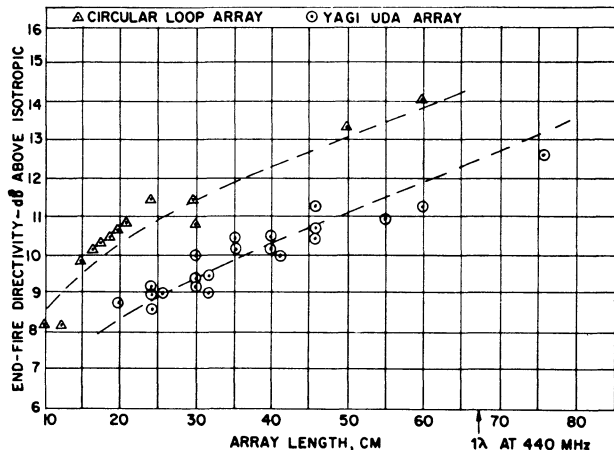

Fig. 4-58 – Comparative directivity (and gain) of the Yagi and quad as a function of overall array length. Although measured with circular loops, the performance with the square loops used in the quad is comparable. The measurements were made on model antennas at 440 MHz (W7ZQ) but also apply at lower frequencies.

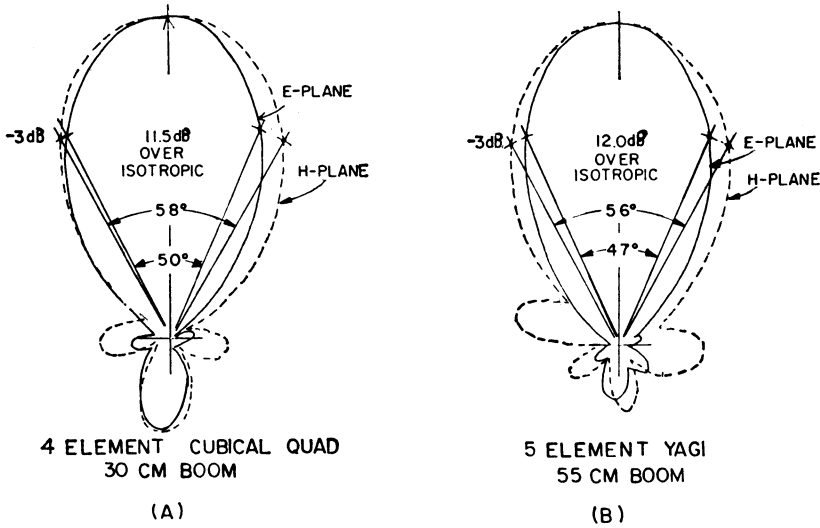

Fig. 5-59 — Measured patterns of 4-element quad and 5-element Yagi antennas, showing approximately equivalent beamwidths. Measurements made on model antennas at 440 MHz by W7ZQ.

subtracting 2.14 dB. The gains were calculated from the measured patterns shown in Fig. 4-59.

The experimentally measured pattern in Fig. 4-59 shows that the beamwidths are approximately

the same for the quad and Yagi when the overall length of the latter is about twice (more closely, 1.8 times) the length of the quad, indicating that under such conditions the gains are about equal.

## THE LOG-PERIODIC DIPOLE ARRAY

The log-periodic dipole array (LPDA) consists of a system of driven elements, but not all elements in the system are active on a single frequency of operation. Depending upon its design parameters, the LPDA can be operated over a range of frequencies having a ratio of 2:1 or higher, and over this range its electrical characteristics — gain, feed-point impedance, front-to-back ratio, etc. — will remain more or less constant. This is not true of any of the types of antennas discussed earlier in this chapter, for either the gain factor or the front-to-back ratio, or both, deteriorate rapidly as the frequency of operation departs from the design frequency of the array. And because the antenna designs discussed earlier are based upon resonant elements, off-resonance operation introduces reactance which causes the SWR in the feeder system to increase.

As may be seen in Fig. 4-60, the log-periodic array consists of several dipole elements which are each of different lengths and different relative spacings. A distributive type of feeder system is used to excite the individual elements. The element lengths and relative spacings, beginning from the feed point for the array, are seen to increase smoothly in dimension, being greater for each element than for the previous element in the array. It is this feature upon which the design of the LPDA is based, and which permits changes in frequency to be made without greatly affecting the electrical operation. With changes in operating

frequency, there is a smooth transition along the array of the elements which comprise the active region. The following information was provided by Peter Rhodes, K4EWG.

A good LPDA may be designed for any band, hf to uhf, and can be built to meet the amateur's requirements at nominal cost: high forward gain, good front-to-back ratio, low VSWR, and a boom length equivalent to a full sized three-element Yagi. The LPDA exhibits a relatively low SWR (usually not greater than 2 to 1) over a wide band of frequencies. A well-designed LPDA can yield a 1.3-to-1 SWR over a 1.8-to-1 frequency range with a typical directivity of 9.5 dB. (Directivity is the ratio of maximum radiation intensity in the forward direction to the average radiation intensity from the array. Assuming no resistive losses in the antenna system, 9.5 dB directivity equates to 9.5 dB gain over an isotropic radiator or approximately 7.4 dB gain over a half-wave dipole.)

### Basic Theory

The LPDA is frequency independent in that the electrical properties such as the mean resistance level,  $R_0$ , characteristic impedance of the feed line,  $Z_0$ , and driving-point admittance,  $Y_0$ , vary periodically with the logarithm of the frequency. As the frequency  $f_1$  is shifted to another frequency  $f_2$  within the passband of the antenna, the relationship is  $f_2 = f_1/\tau$ , where



$\tau =$  a design parameter, a constant;  $\tau < 1.0$ . Also

$$f_3 = f_1 / \tau^2$$

$$f_4 = f_1 / \tau^3$$

$$\vdots$$

$$f_n = f_1 / \tau^{n-1}$$

$n = 1, 2, 3, \dots n$   
 $f_1 =$  lowest frequency  
 $f_n =$  highest frequency

(Eq. 1)

The design parameter  $\tau$  is a geometric constant near 1.0 which is used to determine the element lengths,  $l$ , and element spacings,  $d$ , as shown in Fig. 4-60. That is,

$$l_2 = \tau l_1$$

$$l_3 = \tau l_2$$

$$\vdots$$

$$l_n = \tau l_{(n-1)}$$

(Eq. 2)

where  $l_n =$  shortest element length, and

$$d_{2,3} = \tau d_{1,2}$$

$$d_{3,4} = \tau d_{2,3}$$

$$\vdots$$

$$d_{n-1,n} = \tau d_{n-2,n-1}$$

(Eq. 3)

where  $d_{2,3} =$  spacing between elements 2 and 3.

Each element is driven with a phase shift of  $180^\circ$  by switching or alternating element connections, as shown in Fig. 4-60. The dipoles near the input, being nearly out of phase and close together, nearly cancel each others' radiation. As the element spacing,  $d$ , expands there comes a point along the array where the phase delay in the transmission line combined with the  $180^\circ$  switch gives a total of  $360^\circ$ . This puts the radiated fields from the two dipoles in phase in a direction toward the apex. Hence, a lobe coming off the apex results.

This phase relationship exists in a set of dipoles known as the "active region." If we assume that an LPDA is designed for a given frequency range, then that design must include an active region of dipoles for the highest and lowest design frequency. It has a bandwidth which we shall call  $B_{ar}$  (bandwidth of the active region).

Assume for the moment that we have a 12-element LPDA. Currents flowing in the elements are both real and imaginary, the real current flowing in the resistive component of the impedance of a particular dipole, and the imaginary flowing in the reactive component. Assume that the operating frequency is such that element number 6 is near to being half-wave resonant. The imaginary parts of the currents in shorter elements 7 to 12 are capacitive, while those in longer elements 1 to 6 are inductive. The capacitive current components in shorter elements 9 and 10 exceed the conductive components; hence, these elements receive little power from the

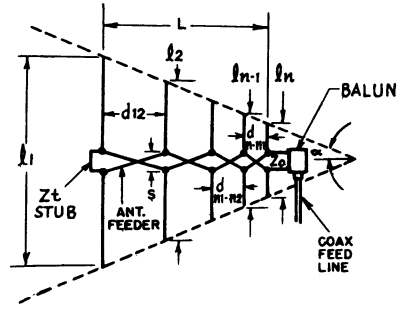

Fig. 4-60 - Schematic diagram of log-periodic dipole array, with some of the design parameters indicated. Design factors are:

$$\tau = \frac{l_n}{l_{n-1}} = \frac{d_{n,n-1}}{d_{n-2,n-1}}$$

$$\sigma = \frac{d_{n,n-i}}{2l_{n-1}}$$

$$h_n = \frac{l_n}{2}, \text{ where}$$

- $l =$  el. length
- $h =$  el. half length
- $d =$  element spacing
- $\tau =$  design constant
- $\sigma =$  relative spacing constant
- $S =$  feeder spacing
- $Z_0 =$  char. impedance of antenna feeder

feeder and act as parasitic directors. The inductive current components in longer elements 4 and 5 are dominant and they act like parasitic reflectors. Elements 6, 7 and 8 receive most of their power from the feeder and act like driven elements. The amplitudes of the currents in the remaining elements are small and they may be ignored as primary contributors to the radiation field. Hence, we have a generalized Yagi array with seven elements comprising the active region. It should be noted that this active region is for a specific set of design parameters ( $\tau = 0.93$ ,  $\sigma = 0.175$ ). The number of elements making up the active region

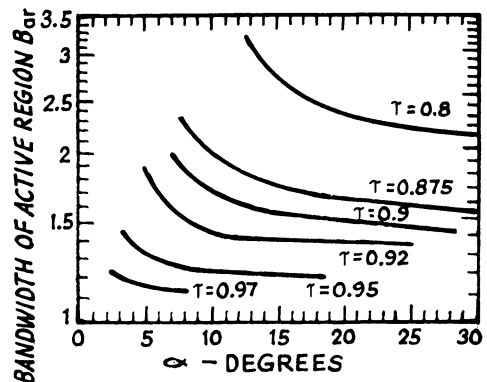

Fig. 4-61.

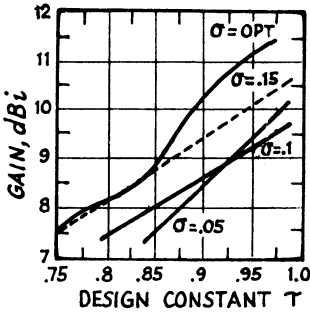

Fig. 4-62.

will vary with  $\tau$  and  $\sigma$ . Adding additional elements on either side of the active region cannot significantly modify the circuit or field properties of the array.

This active region determines the basic design parameters for the array, and sets the bandwidth for the structure,  $B_s$ . That is, for a design-frequency coverage of bandwidth  $B$ , there exists an associated bandwidth of the active region such that

$$B_s = B \times B_{ar} \tag{Eq. 4}$$

where  $B$  = operating bandwidth =  $\frac{f_n}{f_1}$  (Eq. 5)

$f_1$  = lowest freq., MHz  
 $f_n$  = highest freq., MHz

$B_{ar}$  varies with  $\tau$  and  $\alpha$  as shown in Fig. 4-61. Element lengths which fall outside  $B_{ar}$  play an insignificant role in the operation of the array. The gain of an LPDA is determined by the design parameter  $\tau$  and the relative element spacing constant  $\sigma$ . There exists an optimum value for  $\sigma$ ,  $\sigma_{opt}$ , for each  $\tau$  in the range  $0.8 \leq \tau < 1.0$ , for which the gain is maximum; however, the increase in gain achieved by using  $\sigma_{opt}$  and  $\tau$  near 1.0 (i.e.,  $\tau = 0.98$ ) is only 3 dB above isotropic (3 dBi) when compared with the minimum  $\sigma$  ( $\sigma_{min} = .05$ ) and  $\tau = 0.9$ , shown in Fig. 4-62.

An increase in  $\tau$  means more elements and optimum  $\sigma$  means a long boom. A high-gain (8.5 dBi) LPDA can be designed in the hf region with  $\tau = 0.9$  and  $\sigma = .05$ . The relationship of  $\tau$ ,  $\sigma$ , and  $\alpha$  is as follows:

$$\sigma = (1/4) (1 - \tau) \cot \alpha \tag{Eq. 6}$$

where  $\alpha = 1/2$  the apex angle  
 $\tau$  = design constant  
 $\sigma$  = relative spacing constant

$$\text{also } \sigma = \frac{d_{n,n} - 1}{2l_n - 1} \tag{Eq. 7}$$

$$\sigma_{opt} = 0.258\tau - .066 \tag{Eq. 8}$$

The method of feeding the antenna is rather simple. As shown in Fig. 4-60, a balanced feeder is required for each element, and all adjacent elements are fed with a  $180^\circ$  phase shift by alternating element connections. In this section the

term *antenna feeder* is defined as that line which connects each adjacent element. The *feed line* is that line between antenna and transmitter. The characteristic impedance of the antenna feeder,  $Z_o$ , must be determined so that the feed-line impedance and type of balun can be determined. The antenna-feeder impedance  $Z_o$  depends on the mean radiation resistance level  $R_o$  (required input impedance of the active region elements – see Fig. 4-63) and average characteristic impedance of a dipole,  $Z_a$ . ( $Z_a$  is a function of element radius  $a$  and the resonant element half length, where  $h = \lambda/4$ . See Fig. 4-64.) The relationship is as follows:

$$Z_o = \frac{R_o^2}{8 \sigma' Z_a} + R_o \sqrt{\left(\frac{R_o}{8 \sigma' Z_a}\right)^2 + 1} \tag{Eq. 9}$$

where  $Z_o$  = characteristic impedance of feeder

$R_o$  = mean radiation resistance level or required input impedance of the active region.

$Z_a$  = average characteristic impedance of a dipole

$$= 120 \left( \ln \frac{h}{a} - 2.55 \right) \tag{Eq. 10}$$

$h$  = el. half length

$a$  = radius of el.

$$\sigma' = \text{mean spacing factor} = \frac{\sigma}{\sqrt{\tau}} \tag{Eq. 11}$$

From Fig. 4-63 we can see that  $R_o$  decreases with increasing  $\tau$  and increasing  $\alpha$ . Also the VSWR with respect to  $R_o$  has a minimum value of about 1.1 to 1 at  $\sigma$  optimum, and a value of 1.8 to 1 at  $\sigma = .05$ . These SWR values are acceptable when using standard RG-8/U 52-ohm and RG-11/U 72-ohm coax for the feed line. However, a one-to-one VSWR match can be obtained at the transmitter end using a coax-to-coax Transmatch. A Transmatch will enable the transmitter low-pass filter to see a 52-ohm load on each frequency within the array passband. The Transmatch also eliminates possible harmonic radiation caused by the frequency-independent nature of the array.

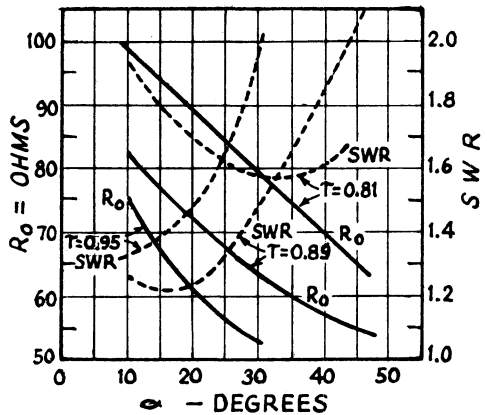

Fig. 4-63.

Once the value of  $Z_0$  has been determined for each band within the array passband, the balun and feed line may be chosen. That is, if  $Z_0 = 100$  ohms, a good choice for the balun would be 1 to 1 balanced to unbalanced, and 72-ohm coax feed line. If  $Z_0 = 220$  ohms, choose a 4 to 1 balun, and 52-ohm coax feed line, and so on. The balun may be omitted if the array is to be fed with an open-wire feed line.

The terminating impedance,  $Z_t$ , may be omitted. However, if it is used, it should have a length no longer than  $\lambda_{max}/8$ . The terminating impedance tends to increase the front-to-back ratio for the lowest frequency used. For hf-band operation a 6-inch shorting jumper wire may be used for  $Z_t$ . When  $Z_t$  is simply a short-circuit jumper the longest element behaves as a passive reflector. It also might be noted that one could increase the front-to-back ratio on the lowest frequency by moving the passive reflector (No. 1 element) a distance of 0.15 to 0.25  $\lambda$  behind element No. 2, as would be done in the case of an ordinary Yagi parasitic reflector. This of course would necessitate lengthening the boom. The front-to-back ratio increases somewhat as the frequency increases. This is because more of the shorter inside elements form the active region, and the longer elements become additional reflectors.

**Design Procedure**

A systematic step-by-step design procedure of the LPDA follows. This procedure may be used for designing any LPDA for any desired bandwidth.

1) Decide on an operating bandwidth  $B$  between  $f_1$ , lowest frequency and  $f_n$ , highest frequency, using Eq. 5.

2) Choose  $\tau$  and  $\sigma$  to give a desired gain (Fig. 4-62).

$$0.8 \leq \tau \leq 0.98$$

$$.05 \leq \sigma \leq \sigma_{opt}$$

The value of  $\sigma_{opt}$  may be determined from Eq. 8.

3) Determine the apex half-angle  $\alpha$

$$\cot \alpha = \frac{4\sigma}{1 - \tau}$$

4) Determine the bandwidth of the active group  $B_{ax}$  from Fig. 4-61.

5) Determine the structure (array) bandwidth  $B_s$  from Eq. 4.

6) Determine the boom length,  $L$ , number of elements,  $N$ , and longest element length,  $l_1$ .

$$L = \left[ \frac{1}{4} \left( 1 - \frac{1}{B_s} \right) \cot \alpha \right] \lambda_{max} \tag{Eq. 12}$$

$$N = 1 + \frac{\log B_s}{\log \left( \frac{1}{\tau} \right)} \tag{Eq. 13}$$

$$l_1 = \frac{492}{f_1}$$

where  $\lambda_{max}$  = longest free-space wavelength =  $984/f_1$ . Examine  $L$ ,  $N$  and  $l_1$  and determine whether or not the array size is acceptable for your

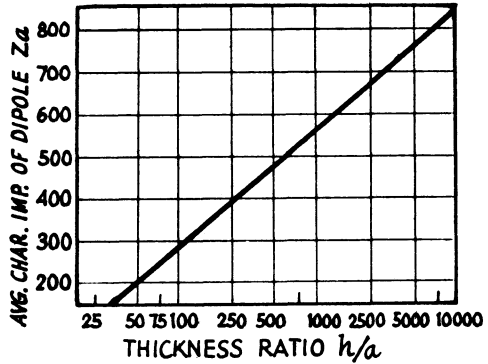

Fig. 4-64.

needs. If the array is too large, increase  $\alpha$  by  $5^\circ$  and repeat steps 2 through 6.

7) Determine the terminating stub  $Z_t$ . (Note: For hf arrays short out the longest element with a 6-inch jumper. For vhf and uhf arrays use:

$$Z_t = \lambda_{max}/8.$$

8) Once the final values of  $\tau$  and  $\sigma$  are found, the characteristic impedance of the feeder  $Z_0$  must be determined so the type of balun and feed line can be found. Use Eq. 9. Determine  $R_0$  from Fig. 4-63,  $Z_a$  from Fig. 4-64 and  $\sigma'$  from Eq. 11. Note: Values for  $h/a$ ,  $Z_a$ , and  $Z_0$  must be determined for each amateur band within the array passband. Choose the element half-length  $h$  nearest  $h = \lambda/4$ , at the center frequency of each amateur band. Once  $Z_0$  is found for each band, choose whatever combination of balun and feed line will give the lowest SWR on each band.

9) Solve for the remaining element lengths from Eq. 2.

10) Determine the element spacing  $d_{12}$  from

$$d_{12} = 1/2 (l_1 - l_2) \cot \alpha \tag{Eq. 14}$$

and the remaining element-to-element spacings from Eq. 3.

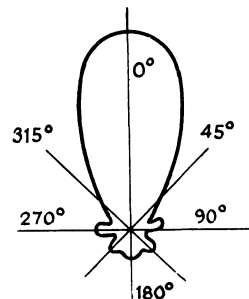

Fig. 4-65 - Measured radiation pattern for the lowest frequency band (14 MHz) of a 12-element 13-30 MHz log-periodic dipole array. For its design parameters,  $\tau = 0.9$  and  $\sigma = .05$ . The measured front-to-back ratio is 14.4 dB at 14 MHz, and increases to 21 dB at 28 MHz.

This completes the design. Construction information for an array designed by this procedure is contained in Chapter Nine. The measured radiation pattern for a 12-element LPDA is shown in Fig. 4-65.

This section has dealt with the basic LPDA system. However, there are several high-gain array possibilities using this type of antenna as a basis. Tilting the elements toward the apex will increase the gain 3 to 5 dB. Adding parasitic directors and a reflector will increase both gain and front-to-back ratio for a specific frequency within the passband. The LPDA-Yagi combination is very simple. Use the LPDA design procedures within the set of driven elements, and place parasitic elements at normal Yagi spacings from the LPDA end elements. Use standard Yagi design procedures for the parasitic elements. An example of a single-band high-gain LPDA-Yagi would be a two- or three-element LPDA for 21.0 to 21.45 MHz with the addition of 2 or 3 parasitic directors and one parasitic reflector. The combinations are endless.

### Bibliography

Source material and more extended discussion of topics covered in this chapter can be found in the references given below.

- Brown, "Directional Antennas," *Proc. I.R.E.*, January, 1937
- Carrel, "The Design of Log-Periodic Dipole Antennas," *1961 IRE International Convention Record*, Part 1, Antennas and Propagation, pp. 61-75; also Ph.D. thesis, University of Ill., Urbana, Ill., 1961.
- Carter, "Circuit Relations in Radiating Systems and Applications to Antenna Problems," *Proc. I.R.E.*, June, 1932.
- Ehrenspek and Poehler, "A New Method of Obtaining Maximum Gain from Yagi Antennas," *I.R.E. Transactions on Antennas and Propagation*, October, 1959.
- Gillson, "Parasitic-Array Patterns," *QST*, March, 1949.
- Greenblum, "Notes on the Development of Yagi Arrays," *QST*, Part I, August, 1956; Part II, September, 1956.
- Hall and Myers, "Phased Verticals in a 40-Meter Beam-Switching Array," *QST*, August, 1972.
- Isbell, "Log Periodic Dipole Arrays," *IRE Transactions on Antennas and Propagation*, Vol. AP-8, No. 3, May, 1960, pp. 260-267.
- Kasper, "Optimum Stacking Spacings in Antenna Arrays," *QST*, April, 1958.
- King, Mack, and Sandler, *Arrays of Cylindrical Dipoles*, pp. 244-269, Cambridge Univ. Press, London, 1968.
- Kmosko and Johnson, "Long Long Yagis," *QST*, January, 1956.
- Kraus, "Directional Antennas with Closely-Spaced Elements," *QST*, January, 1938.
- Ladner and Stoner, *Short-Wave Wireless Communication*, John Wiley & Sons, Inc., New York, N.Y.
- Laport, *Radio Antenna Engineering*, McGraw-Hill Book Co., New York, N.Y.
- Lawson, "Simple Arrays of Vertical Antenna Elements," *QST*, May, 1971.
- Lindsay, "Quads and Yagis," *QST*, May, 1968.
- Rhodes, "The Log-Periodic Dipole Array," *QST*, Nov., 1973.
- Romander, "The Extended Double Zepp Antenna," *QST*, June, 1938.
- Rumsey, *Frequency Independent Antennas*, pp. 71-78, Academic Press, N.Y., 1966.
- Southworth, "Certain Factors Affecting the Gain of Directive Antennas," *Proc. I.R.E.*, September, 1930.
- Terman, *Radio Engineering*, McGraw-Hill Book Co., New York, N.Y.
- Uda and Mushiake, *Yagi-Uda Antenna*, Sasaki Publishing Co., Sendai, Japan.

# Long-Wire Antennas

The power gain and directive characteristics of the harmonic wires (which are "long" in terms of wavelength) described in Chapter Two make them useful for long-distance transmission and reception on the higher frequencies. In addition, long wires can be combined to form antennas of various shapes that will increase the gain and directivity over a single wire. The term "long wire," as used in this chapter, means any such configuration, not just a straight-wire antenna.

## Long Wires vs. Multielement Arrays

In general, the gain obtained with long-wire antennas is not as great, when the space available for the antenna is limited, as can be secured from the multielement arrays in Chapter Four. To offset this the long-wire antenna has advantages of its own. The construction of long-wire antennas is simple both electrically and mechanically, and there are no especially critical dimensions or adjustments. The long-wire antenna will work well and give satisfactory gain and directivity over a 2-to-1 frequency range; in addition, it will accept power and radiate it well on any frequency for which its overall length is not less than about a half wavelength. Since a wire is not "long," even at 28 MHz, unless its length is at least equal to a half wavelength on 3.5 MHz, any long-wire antenna can be used on all amateur bands that are useful for long-distance communication.

As between two directive antennas having the same theoretical gain, one a multielement array and the other a long-wire antenna, many amateurs have found that the long-wire antenna seems more effective in reception. One possible explanation is

that there is a diversity effect with a long-wire antenna because it is spread out over a large distance, rather than being concentrated in a small space; this may raise the average level of received energy for ionospheric propagation. Another factor is that long-wire antennas have directive patterns that are sharp in both the horizontal and vertical planes, and tend to concentrate the radiation at the low vertical angles that are most useful at the higher frequencies. This is not true of some types of multielement arrays.

## General Characteristics of Long-Wire Antennas

Whether the long-wire antenna is a single wire running in one direction or is formed into a V, rhombic, or some other configuration, there are certain general principles that apply and some performance features that are common to all types. The first of these is that the power gain of a long-wire antenna as compared with a half-wave dipole is not considerable until the antenna is really "long" — long, that is, when the lengths are measured in wavelengths, rather than in a specific number of feet. The reason for this is that the fields radiated by elementary lengths of wire along the antenna do not combine, at a distance, in as simple a fashion as the fields from half-wave dipoles used as described in Chapter Four. There is no point in space, for example, where the distant fields from all points along the wire are exactly in phase (as they are, in the optimum direction, in the case of two or more collinear or broadside dipoles when fed with in-phase currents). Consequently, the field strength at a distance always is less than

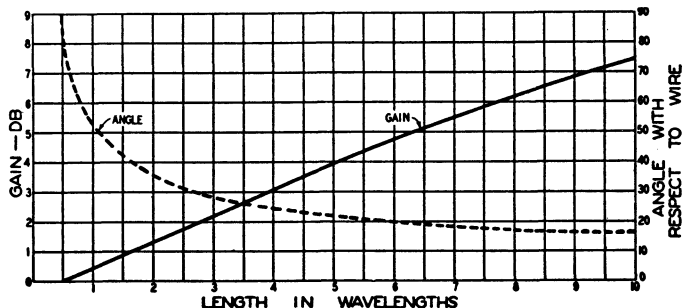

Fig. 5-1 — Theoretical gain of a long-wire antenna over a dipole as a function of wire length. The angle, with respect to the wire, at which the radiation intensity is maximum also is shown.

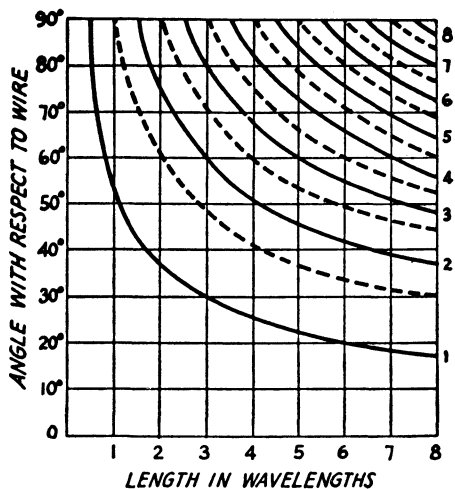

Fig. 5-2 — Angles at which radiation from long wires is maximum (solid curves) and zero (broken curves). The major lobe, No. 1, has the power gains given by Fig. 5-1. Secondary lobes have smaller amplitude, but the maxima may exceed the radiation intensity from a half-wave dipole.

would be obtained if the same length of wire were cut up into properly phased and separately driven dipoles. As the wire is made longer the fields combine to form an increasingly intense main lobe, but this lobe does not develop appreciably until the wire is several wavelengths long. This is indicated by the curve showing gain in Fig. 5-1. The longer the antenna, the sharper the lobe becomes, and since it is really a cone of radiation about the wire in free space, it becomes sharper in all planes. Also, the greater the length, the smaller the angle with the wire at which the maximum radiation occurs.

### Directivity

Because many points along a long wire are carrying currents in different phase (usually with different current amplitude as well) the field pattern at a distance becomes more complex as the wire is made longer. This complexity is manifested in a series of minor lobes, the number of which increases with the wire length. The intensity of radiation from the minor lobes is frequently as great as, and sometimes greater than, the radiation from a half-wave dipole. The energy radiated in the minor lobes is not available to improve the gain in the major lobe, which is another reason why a long-wire antenna has to be long to give appreciable gain.

Driven and parasitic arrays of the simple types described in Chapter Four do not have minor lobes of any great consequence. For that reason they frequently seem to have better directivity than long-wire antennas, because their response in directions other than that at which the antenna is aimed is well down. This will be so even if a multielement array and a long-wire antenna have the same actual

gain in the favored direction. For amateur work, particularly with directive antennas that cannot be rotated, the minor lobes of a long-wire antenna have some advantages. In most directions the antenna will be as good as a half-wave dipole, and in addition will give high gain in the most favored direction; thus a long-wire antenna (depending on the design) frequently is a good all-around radiator in addition to being a good directive antenna.

In the discussion of directive patterns of long-wire antennas in this chapter, it should be kept in mind that the radiation patterns of resonant long wires are based on the assumption that each half-wave section of wire carries a current of the same amplitude. As pointed out in Chapter Two, this is not exactly true, since energy is radiated as it travels along the wire. For this reason it is to be anticipated that, although the theoretical pattern is bidirectional and identical in both directions, actually the radiation (and reception) will be best in one direction. This effect becomes more marked as the antenna is made longer.

### Wave Angles

The wave angle at which maximum radiation takes place from a long-wire antenna depends largely on the same factors that operate in the case of simple dipoles and multielement antennas. That is, the directive pattern in the presence of ground is found by multiplying the free-space vertical-plane pattern of the antenna by the ground-reflection factors for the particular antenna height used. These factors are discussed in Chapter Two.

As mentioned a few paragraphs ago, the free-space radiation pattern of a long-wire antenna has a major lobe that forms a cone around the wire. The angle at which maximum radiation takes place becomes smaller, with respect to the wire, as the wire length is increased, also shown in Fig. 5-1. For this reason a long-wire antenna is primarily a low-angle radiator when installed horizontally above the ground. Its performance in this respect is improved by selecting a height that also tends to concentrate the radiation at low wave angles.

Antenna systems formed from ordinary horizontal dipoles that are not stacked have, in most cases, a rather broad vertical pattern; the wave angle at which the radiation is maximum therefore depends chiefly on the antenna height. However, with a long-wire antenna the wave angle at which the major lobe is maximum can never be higher than the angle at which the first null occurs (see Fig. 5-2), even if the antenna height is very low. (The efficiency may be less at very small heights, partly because of increased losses in the ground and partly because the pattern is affected in such a way as to put a greater porportion of the total power into the minor lobe.) The result is that when radiation at wave angles below 15 or 20 degrees is under consideration, a long-wire antenna is less sensitive to height than are the multielement arrays or a simple dipole. To assure good results, however, the antenna should have a height equivalent to at least a half wavelength at 14 MHz — that is, a minimum height of about 30 feet. Greater heights

will give a worthwhile improvement at wave angles below 10 degrees.

With an antenna of fixed physical length and height, both length and height increase, in terms of wavelength, as the frequency is increased. The overall effect is that both the antenna and the ground reflections tend to keep the system operating at high effectiveness throughout the frequency range. At low frequencies the wave angle is raised, but high wave angles are useful at 3.5 and 7 MHz. At high frequencies the converse is true. Good all-around performance usually results on all bands when the antenna is designed to be optimum in the 14-MHz band.

**Calculating Length**

In this chapter lengths are always discussed in terms of wavelengths. There can obviously be nothing very critical about wire lengths in an antenna system that will work over a frequency

range including several amateur bands. The antenna characteristics change very slowly with length, except when the wires are short (i.e., around one wavelength), and there is no need to try to establish exact resonance at a particular frequency.

The formula for harmonic wires given in Chapter Two is quite satisfactory for determining the lengths of any of the antenna systems to be described. For convenience, the formula is repeated here in the following form:

$$Length \text{ (feet)} = \frac{984 (N - 0.025)}{\text{Freq. (MHz)}}$$

where *N* is the number of full waves on the antenna. In cases where exact resonance is desired for some reason (for obtaining a resistive load for a transmission line at a particular frequency, for example) it is best established by trimming the wire length until measurement of the resonant frequency shows it to be correct.

**LONG SINGLE WIRES**

In Fig. 5-1 the solid curve shows that the gain in decibels of a long wire increases almost linearly with the length of the antenna. The gain does not become appreciable until the antenna is about four wavelengths long, where it is equivalent to doubling the transmitter power (3 dB). The actual gain over a half-wave dipole when the antenna is at a practical height above ground will depend on the way in which the radiation resistances of the long-wire antenna and the comparison dipole are affected by the height. The exact way in which the radiation resistance of a long wire varies with height depends on its length. In general, the resistance does not fluctuate as much, in terms of percentage, as does the resistance of a half-wave antenna. This is particularly true at heights from one-half wavelength up.

The nulls bounding the lobes in the directive pattern of a long wire are fairly sharp and are frequently somewhat obscured, in practice, by irregularities in the pattern. The locations of nulls and maxima for antennas up to eight wavelengths long are shown in Fig. 5-2.

**Orientation**

The broken curve of Fig. 5-1 shows the angle with the wire at which the radiation intensity is maximum. As shown in Chapter Two, there are two main lobes to the directive patterns of long-wire antennas; each makes the same angle with respect to the wire. The solid pattern, considered in free space, is the hollow cone formed by rotating the wire on its axis.

When the antenna is mounted horizontally above the ground, the situation depicted in Fig. 5-3

exists. Only one of the two lobes is considered in this drawing, and its lower half is cut off by the ground. The maximum intensity of radiation in the remaining half occurs through the broken-line semicircle; that is, the angle *B* (between the wire direction and the line marked *wave direction*) is the angle given by Fig. 5-1 for the particular antenna length used.

In the practical case, there will be some wave angle (*A*) that is optimum for the frequency and the distance between the transmitter and receiver. Then for that wave angle the wire direction and the optimum geographical direction of transmission are related by the angle *C*. If the wave angle is very low, *B* and *C* will be practically equal. But as the wave angle becomes higher the angle *C* becomes smaller; in other words, the best direction of transmission and the direction of the wire more nearly coincide. They coincide exactly when *C* is zero; that is, when the wave angle is the same as the angle given by Fig. 5-1.

The maximum radiation from the antenna can be aligned with a particular geographical direction

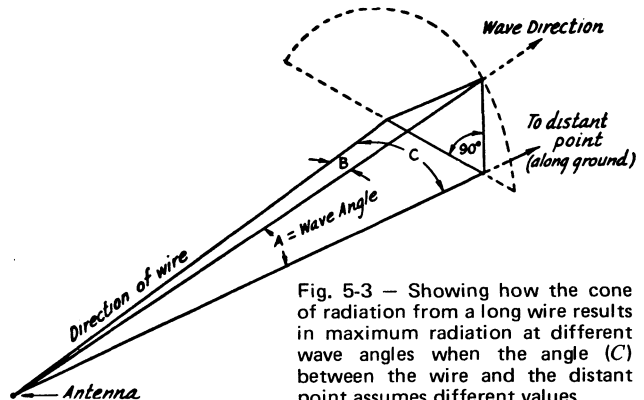

Fig. 5-3 — Showing how the cone of radiation from a long wire results in maximum radiation at different wave angles when the angle (*C*) between the wire and the distant point assumes different values.

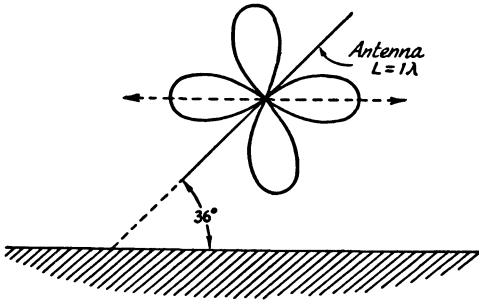

Fig. 5-4 — Alignment of lobes for horizontal transmission by tilting a long wire in the vertical plane.

at a given wave angle by means of the following formula:

$$\cos C = \frac{\cos B}{\cos A}$$

In most amateur work the chief requirement is that the wave angle should be as low as possible, particularly at 14 MHz and above. In such case it is usually satisfactory to make angle  $C$  the same as is given by Fig. 5-1.

It should be borne in mind that only the *maximum* point of the lobe is represented in Fig. 5-3. Radiation at higher or lower wave angles in any given direction will be proportional to the way in which the actual pattern shows the field strength to vary as compared with the maximum point of the lobe.

#### Tilted Wires

Fig. 5-3 shows that when the wave angle is equal to the angle which the maximum intensity of the lobe makes with the wire, the best transmitting or receiving direction is that of the wire itself. If the wave angle is less than the lobe angle, the best direction can be made to coincide with the direction of the wire by tilting the wire enough to

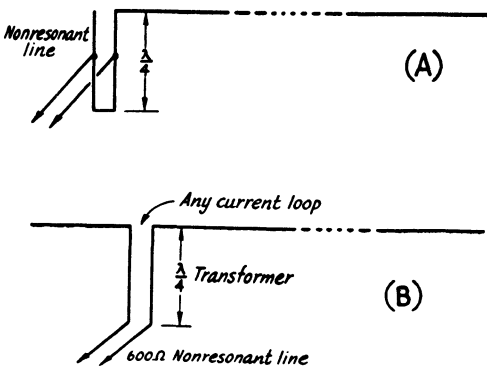

Fig. 5-5 — Methods of feeding long single-wire antennas.

make the lobe and wave angle coincide. This is shown in Fig. 5-4, for the case of a one-wavelength antenna tilted so that the maximum radiation from one lobe is horizontal to the left, and from the other is horizontal to the right (zero wave angle). The solid pattern can be visualized by imagining the plane diagram rotating about the antenna as an axis.

Since the antenna is neither vertical nor horizontal in this case, the radiation is part horizontally polarized and part vertically polarized. Computing the effect of the ground becomes complicated, because the horizontal and vertical components must be handled separately. In general, the directive pattern at any given wave angle becomes unsymmetrical when the antenna is tilted. For small amounts of tilt (less than the amount that directs the lobe angle horizontally) and for low wave angles the effect is to shift the optimum direction closer to the line of the antenna. This is true in the direction in which the antenna slopes downward. In the opposite direction the low-angle radiation is reduced.

#### Feeding Long Wires

It has been pointed out in Chapter Three that a harmonic antenna can be fed only at the end or at a current loop. Since a current loop changes to a node when the antenna is operated at any even multiple of the frequency for which it is designed, a long-wire antenna will operate as a true long wire *on all bands* only when it is fed at the end.

A common method of feeding is to use a resonant open-wire line, as described in Chapter Three. This system will work on all bands down to the one, if any, at which the antenna is only a half wave long. Any convenient line length can be used if the transmitter is matched to the line input impedance by the methods described in Chapter Three.

Two arrangements for using nonresonant lines are given in Fig. 5-5. The one at A is useful for one band only since the matching section must be a quarter wave long, approximately, unless a different matching section is used for each band. In B, the Q-section impedance should be adjusted to match the antenna to the line as described in Chapter Three, using the value of radiation resistance given in Fig. 2-20. This method is best suited to working with a 600-ohm transmission line. Although it will work as designed only on one band, the antenna can be used on other bands by treating the line and matching transformer as a resonant line. In such case, as mentioned earlier, the antenna will not radiate as a true long wire on even multiples of the frequency for which the matching system is designed.

The end-fed arrangement, although the most convenient when tuned feeders are used, suffers the disadvantage that there is likely to be a considerable antenna current on the line, as described in Chapter Three. In addition, the antenna reactance changes rapidly with frequency for the reasons outlined in Chapter Two (Figs. 2-9 and 2-10). Consequently, when the wire is several



wavelengths long a relatively small change in frequency — a fraction of the width of a band — may require major changes in the adjustment of the transmitter-to-line coupling apparatus. Also, the line becomes unbalanced at all frequencies

between those at which the antenna is exactly resonant. This leads to a considerable amount of radiation from the line. The unbalance can be overcome by using two wires in one of the arrangements described in succeeding sections.

## COMBINATIONS OF RESONANT LONG WIRES

The directivity and gain of long wires may be increased by using two wires so placed in relation to each other as to make the fields from both combine to produce the greatest possible field strength at a distant point. The principle is similar to that used in forming the multielement arrays described in Chapter Four. However, the maximum radiation from a long wire occurs at an angle of less than 90 degrees with respect to the wire, so different physical relationships must be used.

### Parallel Wires

One possible method of using two (or more) long wires is to place them in parallel, with a spacing of  $1/2$  wavelength or so, and feed the two in phase. In the direction of the wires the fields will add up in phase. However, since the wave angle is greatest in the direction of the wire, as shown by Fig. 5-3, this method will result in rather high-angle radiation unless the wires are several wavelengths long. The wave angle can be lowered, for a given antenna length, by tilting the wires as described earlier. With a parallel arrangement of this sort the gain should be about 3 dB over a single wire of the same length, at spacings in the vicinity of  $1/2$  wavelength.

### THE V ANTENNA

Instead of using two long wires parallel to each other they may be placed in the form of a horizontal V, with the angle at the apex of the V equal to twice the angle given by Fig. 5-1 for the particular length of wire used. The currents in the two wires should be out of phase. Under these conditions the plane directive patterns of the individual wires combine as is indicated in Fig. 5-6. Along a line in the plane of the antenna and bisecting the V the fields from the individual wires reinforce each other at a distant point. The other pair of lobes in the plane pattern is more or less

eliminated, so that the pattern becomes essentially bidirectional.

The directional pattern of an antenna of this type is sharper in both the horizontal and vertical planes than the patterns of the individual wires composing it. Maximum radiation in both planes is along the line bisecting the V. There are minor lobes in both the horizontal and vertical patterns but if the legs are long in terms of wavelength the amplitude of the minor lobes is small. When the antenna is mounted horizontally above the ground (the usual method) the wave angle at which the radiation from the major lobe is maximum is determined by the height, but cannot exceed the angle values shown in Fig. 5-1 for the leg length used. Only the minor lobes give high-angle radiation.

The gain and directivity of a V depend on the length of the legs. An approximate idea of the gain for the V antenna may be obtained by adding 3 dB to the gain value from Fig. 5-1 for the corresponding leg length. The actual gain will be modified by the mutual impedance between the sides of the V, and will be somewhat higher than indicated by the values determined as above, especially at the longer leg lengths. With 8-wavelength legs, the gain is approximately 4 dB greater than that indicated for a single wire in Fig. 5-1.

### Lobe Alignment

It is possible to align the lobes from the individual wires with a particular wave angle by the method described in connection with Fig. 5-3. At very low wave angles the change in the apex angle is extremely small; for example, if the desired wave angle is 5 degrees the apex angles of twice the value given in Fig. 5-1 will not be reduced more than a degree or so, even at the longest leg lengths which might be used.

When the legs are long, alignment does not necessarily mean that the greatest signal strength

Fig. 5-6 — Two long wires and their respective patterns are shown at the left. If these two wires are combined to form a V whose apex angle is twice that of the major lobes of the wires and the wires are excited out of phase, the radiation along the bisector of the V adds and the radiation in the other directions tends to cancel.

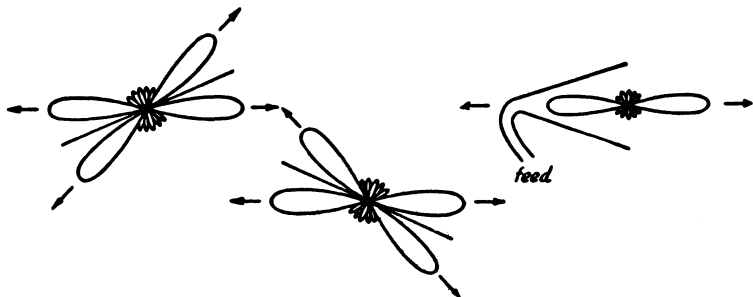

will be secured at the wave angle for which the apex angle is chosen. It must be remembered that the polarization of the radiated field is the same as that of a plane containing the wire. As illustrated by the diagram of Fig. 5-3, at any wave angle other than zero the plane containing the wire and passing through the desired wave angle is not horizontal. In the limiting case where the wave angle and the angle of maximum radiation from the wire are the same the plane is vertical, and the radiation at that wave angle is vertically polarized. At in-between angles the polarization consists of both horizontal and vertical components.

When two wires are combined into a V the polarization planes have opposite slopes. In the plane bisecting the V, this makes the horizontally polarized components of the two fields add together numerically, but the vertically polarized components are out of phase and cancel completely. As the wave angle is increased the horizontally polarized components become smaller, so the intensity of horizontally polarized radiation decreases. On the other hand, the vertically polarized components become more intense but always cancel each other. The overall result is that although alignment for a given wave angle will increase the useful radiation at that angle, the wave angle at which maximum radiation occurs (in the direction of the line bisecting the V) is always below the wave angle for which the wires are aligned. As shown by Fig. 5-7, the difference between the apex angles required for optimum alignment of the lobes at wave angles of zero and 15 degrees is rather small, even when the legs are many wavelengths long.

For long-distance transmission and reception the lowest possible wave angle usually is the best. Consequently, it is good practice to choose an apex angle between the limits represented by the two curves in Fig. 5-7. The actual wave angle at which the radiation is maximum will depend on the shape of the vertical pattern and the height of the antenna above ground.

When the leg length is small, there is some advantage in reducing the apex angle of the V because this changes the mutual impedance in such

a way as to increase the gain of the antenna. For example, the optimum apex angle in the case of  $1-\lambda$  legs is 90 degrees.

### Multiband Design

When a V antenna is used over a range of frequencies — such as 14 to 28 MHz — its characteristics over the frequency range will not change greatly if the legs are sufficiently long at the lowest frequency. The apex angle, at zero wave angle, for a 5-wavelength V (each leg approximately 350 feet long at 14 MHz) is 44 degrees. At 21 MHz, where the legs are 7.5 wavelengths long, the optimum angle is 36 degrees, and at 28 MHz where the leg length is 10 wavelengths it is 32 degrees. Such an antenna will operate well on all three frequencies if the apex angle is about 35 degrees. From Fig. 5-7, a 35-degree apex angle with a 5-wavelength V will align the lobes at a wave angle of something over 15 degrees, but this is not too high when it is kept in mind that the maximum radiation actually will be at a lower angle. At 28 MHz the apex angle is a little large, but the chief effect will be a small reduction in gain and a slight broadening of the horizontal pattern, together with a tendency to reduce the wave angle at which the radiation is maximum. The same antenna can be used at 3.5 and 7 MHz, and on these bands the fact that the wave angle is raised is of less consequence, since high wave angles are useful. The gain will be small, however, because the legs are not long at these frequencies.

### Other V Combinations

The gain can be increased about 3 dB by stacking two Vs one above the other, a half wavelength apart, and feeding them in phase with each other. This will result in a lowered angle of radiation. The bottom V should be at least a quarter wavelength above the ground, and preferably a half wavelength.

Two V antennas can be broadsided to form a W, giving an additional 3-dB gain. However, two transmission lines are required and this, plus the fact that five poles are needed to support the

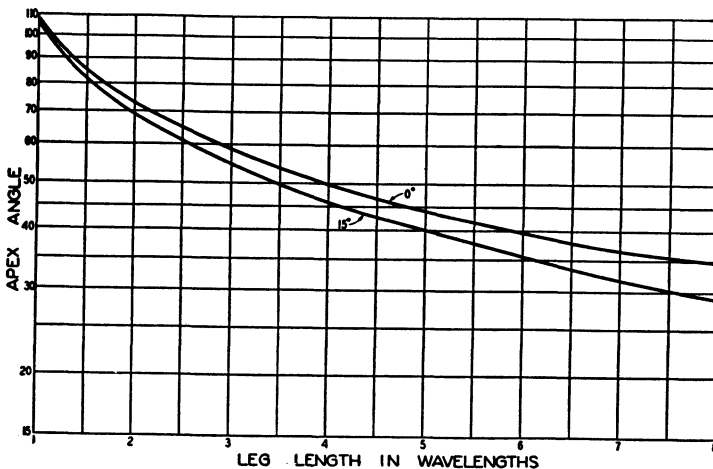

Fig. 5-7 — Apex angle of V antenna for alignment of main lobe at different wave angles, as a function of leg length in wavelengths.

system, renders it normally impractical for the amateur.

The V antenna can be made unidirectional by using another V placed an odd multiple of a quarter wavelength in back of the first and exciting the two with a phase difference of 90 degrees. The system will be unidirectional in the direction of the antenna with the lagging current. However, the V reflector is not normally employed by amateurs at low frequencies because it restricts the use to one band and requires a fairly elaborate supporting structure. Stacked Vs with driven reflectors could, however, be built for the 200- to 500-MHz region without much difficulty. The overall gain for such an antenna (two stacked Vs, each with a V reflector) is about 9 dB greater than the gains given in Fig. 5-1.

#### Feeding the V

The V antenna is most conveniently fed by tuned feeders, since they permit multiband operation. Although the length of the wires in a V beam is not at all critical, it is important that both wires be of the same electrical length. If it is desired to use a nonresonant line, probably the most appropriate matching system is that using a stub or quarter-wave matching section. The adjustment is as described in Chapter Three.

### THE RESONANT RHOMBIC ANTENNA

The diamond-shaped or rhombic antenna shown in Fig. 5-8 can be looked upon as two acute-angle Vs placed end-to-end. This arrangement has two advantages over the simple V that have caused it to be favored by amateurs. For the same total wire length it gives somewhat greater gain than the V; a rhombic 4 wavelengths on a leg, for example, has a gain of better than 1 dB over a V antenna with 8 wavelengths on a leg. And the directional pattern of the rhombic is less affected by frequency than the V when the antenna is used over a wide frequency range. This is because a change in frequency causes the major lobe from one leg to shift in one direction while the lobe from the opposite leg shifts the other way. This tends to make the optimum direction stay the same over a considerable frequency range. The disadvantage of the rhombic as compared with the V is that one additional support is required.

The same factors that govern the design of the V antenna apply in the case of the resonant rhombic. The angle  $A$  in the drawing is the same as that for a V having a leg length equal to  $L$ . If it is

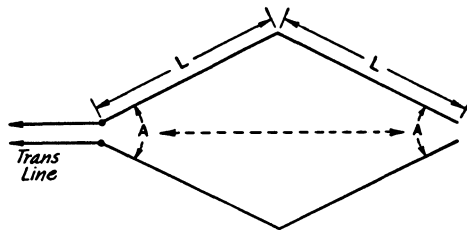

Fig. 5-8 — The resonant rhombic or diamond-shaped antenna. All legs are the same length, and opposite angles of the diamond are equal.

desired to align the lobes from individual wires with the wave angle, the curves of Fig. 5-7 may be used, again using the length of one leg in taking the data from the curves. The diamond-shaped antenna also can be operated as a nonresonant antenna, as described later in this chapter, and much of the discussion in that section applies to the resonant rhombic as well.

The direction of maximum radiation with a resonant rhombic is given by the arrows in Fig. 5-8, i.e., the antenna is bidirectional. There are minor lobes in other directions, their number and intensity depending on the leg length. When used at frequencies below the vhf region the rhombic antenna is always mounted with the plane containing the wires horizontal. The polarization in this plane, and also in the perpendicular plane that bisects the rhombic, is horizontal. At 144 MHz and above, the dimensions are such that the antenna can be mounted with the plane containing the wires vertical if vertical polarization is desired.

When the rhombic antenna is to be used on several amateur bands it is advisable to choose the apex angle,  $A$ , on the basis of the leg length in wavelengths at 14 MHz. This point is covered in more detail in connection both with the V and with the nonresonant rhombic. Although the gain on higher frequency bands will not be quite as favorable as if the antenna had been designed for the higher frequencies, the system will radiate well at the low angles that are necessary at such frequencies. At frequencies below the design frequency the greater apex angle of the rhombic (as compared with a V of the same total length) is more favorable to good radiation than in the case of the V.

The resonant rhombic antenna can be fed in the same way as the V. Resonant feeders are necessary if the antenna is to be used in several amateur bands.

### NONRESONANT LONG-WIRE ANTENNAS

All the antenna systems previously considered have been based on resonant operation, that is, with standing waves of current and voltage along the wire. Although most antenna designs are based on using resonant wires, resonance is by no means a necessary condition for the wire to radiate and intercept electromagnetic waves.

In Fig. 5-9 let us suppose that the wire is parallel with the ground (horizontal) and is terminated by a load  $Z$  equal to its characteristic impedance,  $Z_0$ . The load  $Z$  can represent a receiver matched to the line. The resistor  $R$  is also equal to the  $Z_0$  of the wire. A wave coming from the direction  $X$  will strike the wire first at its far end

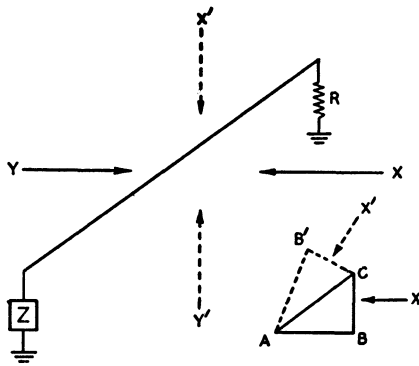

Fig. 5-9 — Nonresonant long-wire antenna.

and sweep across the wire at an angle until it reaches the end at which  $Z$  is connected. In doing so it will induce voltages in the antenna and currents will flow as a result. The current flowing toward  $Z$  is the useful output of the antenna, while the current flowing toward  $R$  will be absorbed in  $R$ . The same thing is true of a wave coming from the direction  $X'$ . In such an antenna there are no standing waves, because all received power is absorbed at either end.

The greatest possible power will be delivered to the load  $Z$  when the individual currents induced as the wave sweeps across the wire all combine properly on reaching the load. The currents will reach  $Z$  in optimum phase when the time required for a current to flow from the far end of the antenna to  $Z$  is exactly one-half cycle longer than the time taken by the wave to sweep over the antenna. Since a half cycle is equivalent to a half wavelength in space, the length of the antenna must be one-half wavelength greater than the distance traversed by the wave from the instant it strikes the far end of the antenna to the instant that it reaches the near end. This is shown by the small drawing, where  $AC$  represents the antenna,  $BC$  is a line perpendicular to the wave direction, and  $AB$  is the distance traveled by the wave in sweeping past  $AC$ .  $AB$  must be one-half wavelength shorter than  $AC$ . Similarly,  $AB'$  must be the same length as  $AB$  for a wave arriving from  $X'$ .

A wave arriving at the antenna from the opposite direction  $Y$  (or  $Y'$ ), will similarly result in the largest possible current at the *far* end. However, the far end is terminated in  $R$ , which is equal to  $Z$ , so all the power delivered to  $R$  by a wave arriving from  $Y$  will be absorbed in  $R$ . The current traveling to  $Z$  will produce a signal in  $Z$  in proportion to its amplitude. If the antenna length is such that all the individual currents arrive at  $Z$  in such phase as to add up to zero, there will be no current through  $Z$ . At other lengths the resultant current may reach appreciable values. The lengths that give zero amplitude are those which are odd multiples of  $1/4$  wavelength, beginning at  $3/4$  wavelength. The response from the  $Y$  direction is greatest when the antenna is any even multiple of

$1/2$  wavelength long; the higher the multiple, the smaller the response.

#### Directional Characteristics

The explanation above considered the phase but not the relative amplitudes of the individual currents reaching the load. When the appropriate correction is made, the angle with the wire at which radiation or response is maximum is given by the curve of Fig. 5-10. The response drops off gradually on either side of the maximum point, resulting in lobes in the directive pattern much like those for harmonic antennas, except that the system is substantially unidirectional. Typical patterns are shown in Fig. 5-11. When the antenna length is  $3/2$  wavelength or greater there are also angles at which secondary maxima occur; these secondary maxima (minor lobes) have their peaks approximately at angles for which the length  $AB$ , Fig. 5-9, is less than  $AC$  by any odd multiple of one-half wavelength. When  $AB$  is shorter than  $AC$  by an *even* multiple of a half wavelength, the induced currents cancel each other completely at  $Z$ , and in such cases there is a null for waves arriving in the direction perpendicular to  $BC$ .

The antenna of Fig. 5-9 responds to horizontally polarized signals when mounted horizontally. If the wire lies in a plane that is vertical with respect to the earth it responds to vertically polarized signals. By reciprocity, the characteristics for transmitting are the same as for receiving. For average conductor diameters and heights above ground, 20 or 30 feet, the  $Z_0$  of the antenna is of the order of 500 to 600 ohms.

It is apparent that an antenna operating in this way has much the same characteristics as a transmission line. When it is properly terminated at both ends there are traveling waves, but no standing waves, on the wire. Consequently the current is substantially the same all along the wire.

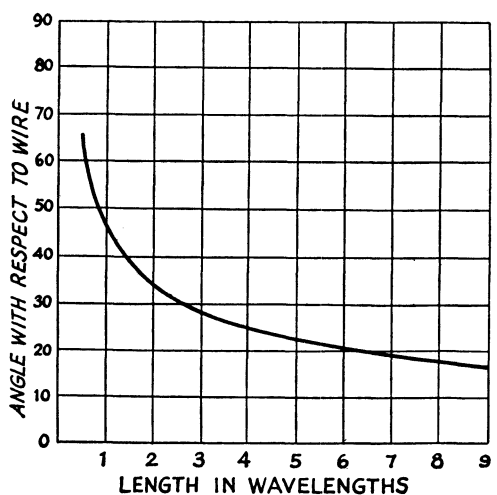

Fig. 5-10 — Angle with respect to wire axis at which the radiation from a nonresonant long-wire antenna is maximum.

Actually, it decreases in the direction in which the current is flowing because of energy loss by radiation as well as by ohmic loss in the wire and the ground. The antenna can be looked upon as a transmission line terminated in its characteristic impedance, but having such wide spacing between conductors (the second conductor in this case is the image of the antenna in the ground) that radiation losses are by no means inconsequential.

A wire terminated in its characteristic impedance will work on any frequency, but its directional characteristics change with frequency as shown by Fig. 5-10. To give any appreciable gain over a dipole the wire must be at least a few wavelengths long. The angle at which maximum response is secured can be in any plane that contains the wire axis, so in free space the major lobe will be a cone. In the presence of ground, the discussion given in connection with Fig. 5-3 applies, with the modification that the angles of best radiation or response are those given in Fig. 5-10, rather than by Figs. 5-1 or 5-2. As comparison of the curves will show, the difference in optimum angle between resonant and nonresonant wires is quite small.

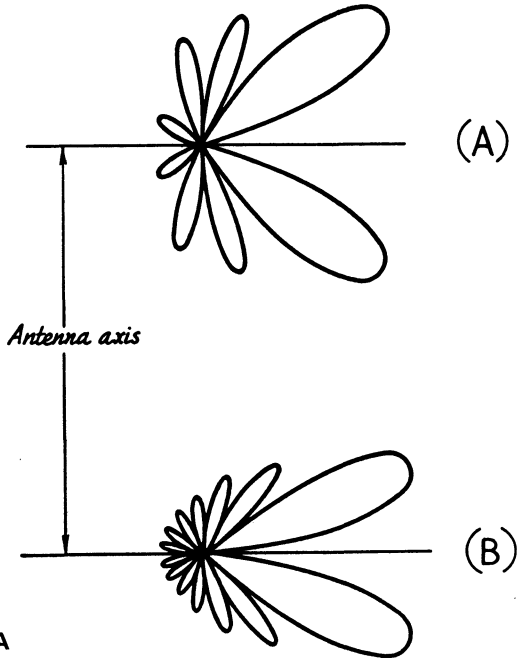

Fig. 5-11 — Typical radiation patterns (cross section of solid figure) for terminated long wires. (A) length two wavelengths, (B) four wavelengths, both for an idealized case in which there is no decrease of current along the wire. In practice, the pattern is somewhat distorted by wire attenuation.

### THE NONRESONANT RHOMBIC ANTENNA

The highest development of the long-wire antenna is the nonresonant rhombic, shown schematically in Fig. 5-12. It consists of four conductors joined to form a diamond, or rhombus. All sides of the antenna have the same length and the opposite corner angles are equal. The antenna can be considered as being made up of two V antennas placed end to end and terminated by a noninductive resistor to produce a unidirectional pattern. The terminating resistor is connected between the far ends of the two sides, and is made approximately equal to the characteristic impedance of the antenna as a unit. The rhombic may be constructed either horizontally or vertically, but practically always is horizontal at frequencies below 54 MHz, since the pole height required is considerably less. Also, horizontal polarization is equally, if not more, satisfactory at these frequencies.

The basic principle of combining lobes of maximum radiation from the four individual wires constituting the rhombus or diamond is the same in either the nonresonant type shown in Fig. 5-12, or the resonant type described earlier in this chapter. The included angles should differ slightly because of the differences between resonant and nonresonant wires, as just described, but the differences are almost negligible.

#### Tilt Angle

It is a matter of custom, in dealing with the nonresonant or terminated rhombic, to talk about the "tilt angle" ( $\phi$  in Fig. 5-12), rather than the angle of maximum radiation with respect to an individual wire. The tilt angle is simply 90 degrees minus the angle of maximum radiation. In the case of a rhombic antenna designed for zero wave angle the tilt angle is 90 degrees minus the values given in Fig. 5-10.

Fig. 5-13 shows the tilt angle as a function of the antenna leg length. The curve marked "0°" is for a wave angle of zero degrees; that is, maximum radiation in the plane of the antenna. The other curves show the proper tilt angles to use when aligning the major lobe with a desired wave angle. For a wave angle of 5 degrees the difference in tilt angle is less than one degree for the range of lengths shown. Just as in the case of the resonant V and resonant rhombic, alignment of the wave angle and lobes always results in still greater radiation at a lower wave angle, and for the same reason, but also results in the greatest possible radiation at the desired wave angle.

The broken curve marked "Optimum Length" shows the leg length at which maximum gain is

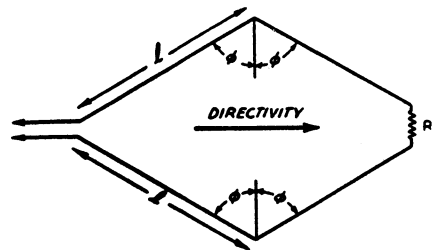

Fig. 5-12 — The nonresonant rhombic antenna.

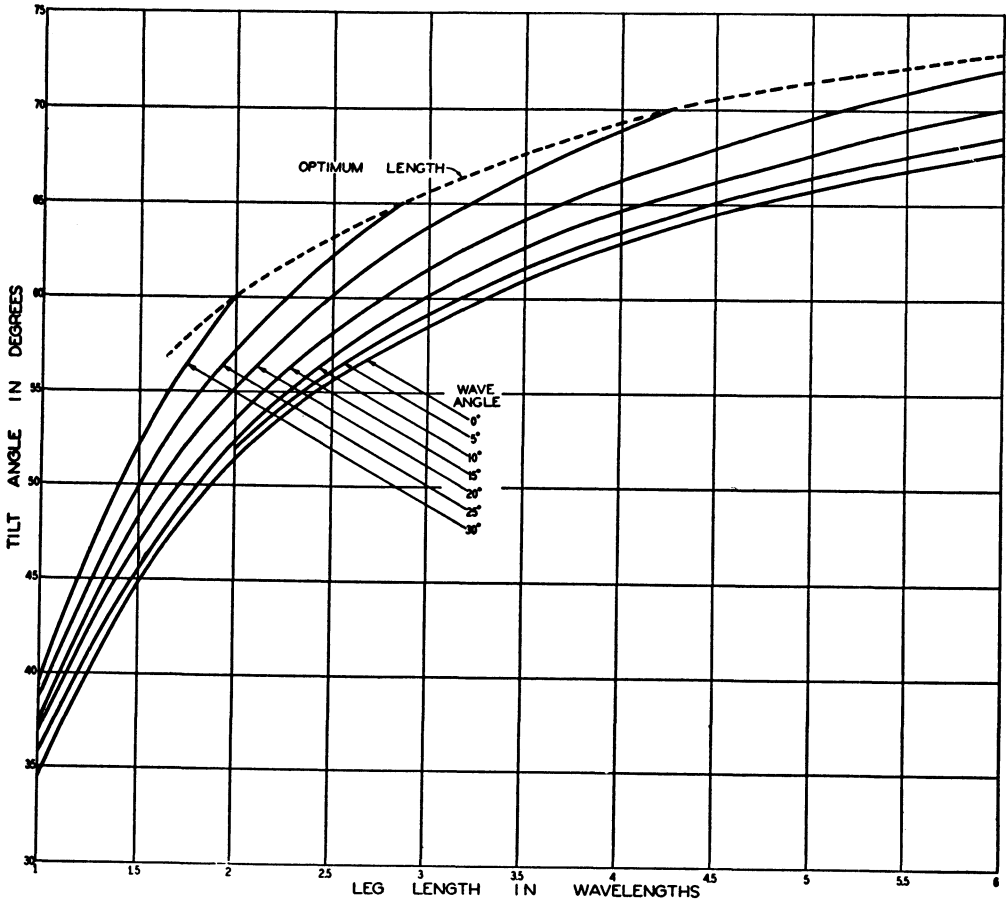

Fig. 5-13 — Rhombic-antenna design chart. For any given leg length, the curves show the proper tilt angle to give maximum radiation at the selected wave angle. The broken curve marked "Optimum Length" shows the leg length that gives the maximum possible output at the selected wave angle. The optimum length as given by the curves should be multiplied by 0.74 to obtain the leg length for which the wave angle and main lobe are aligned (see text, "Alignment of Lobes").

secured at a chosen wave angle. Increasing the leg length beyond the optimum will result in lessened gain, and for that reason the curves do not extend beyond the optimum length. Note that the optimum length becomes greater as the desired wave angle is smaller. Leg lengths over  $6\lambda$  are not recommended because the directive pattern becomes so sharp that the antenna performance is highly variable with small changes in the angle, both horizontal and vertical, at which an incoming wave reaches the antenna. Since these angles vary to some extent in ionospheric propagation, it does not pay to attempt to use too great a degree of directivity.

#### Multiband Design

When a rhombic antenna is to be used over a considerable frequency range it is worth paying some attention to the effect of the tilt angle on the gain and directive pattern at various frequencies.

For example, suppose the antenna is to be used at frequencies up to and including the 28 MHz band, and that the leg length is to be 6 wavelengths on the latter frequency. For zero wave angle the optimum tilt angle is 68 degrees, and the calculated free-space directive pattern in the vertical plane bisecting the antenna is shown in the right-hand drawing of Fig. 5-14. At 14 MHz this same antenna has a leg length of three wavelengths, which calls for a tilt angle of 58.5 degrees for maximum radiation at zero wave angle. The calculated patterns for tilt angles of 58.5 and 68 degrees are shown in the left-hand drawing in Fig. 5-14, and it is seen that if the optimum tilt for 28-MHz operation is used the gain will be reduced and the wave angle raised at 14 MHz. In an attempt at a compromise, we might select a wave angle of 15 degrees, rather than zero, for 14 MHz since, as shown by Fig. 5-13, the tilt angle is larger and thus more nearly coincides with the tilt angle for zero wave angle on 28 MHz. From the chart, the tilt angle for 3 wavelengths on a leg and a 15-degree

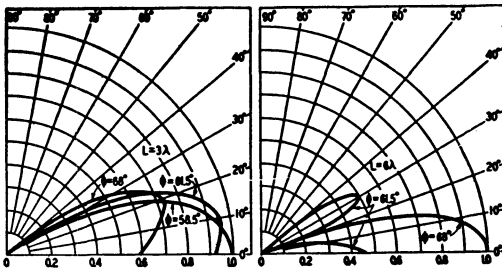

Fig. 5-14 — Showing the effect of tilt angle on the free-space vertical pattern of a nonresonant rhombic antenna having a leg length of 3 wavelengths at one frequency and 6 wavelengths at twice the frequency. These patterns apply only in the direction of the antenna axis.

wave angle is 61.5 degrees. The patterns with this tilt angle are shown in Fig. 5-14 for both the 14- and 28-MHz cases. The effect at 28 MHz is to decrease the gain at zero wave angle by more than 6 dB and to split the radiation in the vertical plane into two lobes, one of which is at a wave angle too high to be useful at this frequency.

Inasmuch as the gain increases with the leg length in wavelengths, it is probably better to favor the lower frequency in choosing the tilt angle. In the present example, the best compromise probably would be to split the difference between the optimum tilt angle for the 15-degree wave angle at 14 MHz and that for zero wave angle at 28 MHz; that is, use a tilt angle of about 64 degrees. Design dimensions for such an antenna are given in Fig. 5-15.

The patterns of Fig. 5-14 are in the vertical plane through the center of the antenna only. In vertical planes making an angle with the antenna axis, the patterns may differ considerably. The effect of a tilt angle that is smaller than the optimum is to broaden the horizontal pattern, so at 28 MHz the antenna in the example would be less directive in the horizontal plane than would be the case if it were designed for optimum performance at that frequency. It should also be noted that the patterns given in Fig. 5-14 are free-space patterns and must be multiplied by the ground-reflection factors for the actual antenna height used, if the actual vertical patterns are to be

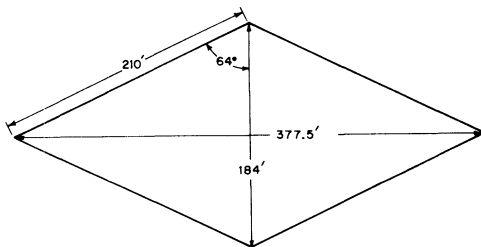

Fig. 5-15 — Rhombic antenna dimensions for a compromise design between 20- and 10-meter requirements, as discussed in the text. The leg length is 6 λ on 10 meters, 3 λ on 20.

determined. (Also see later discussion on lobe alignment.)

Power Gain

The theoretical power gain of a nonresonant rhombic antenna over a dipole, both in free space, is given by the curve of Fig. 5-16. This curve is for zero wave angle and includes an allowance of 3 dB for power dissipated in the terminating resistor. The actual gain of an antenna mounted horizontally above the ground, as compared with a dipole at the same height, can be expected to vary a bit either way from the figures given by the curve. The power lost in the terminating resistor is probably less than 3 dB in the average installation, since more than half of the power input is radiated before the end of the antenna is reached. However, there is also more power loss in the wire and in the ground under the antenna than in the case of a simple dipole, so the 3 dB figure is probably a representative estimate of overall loss.

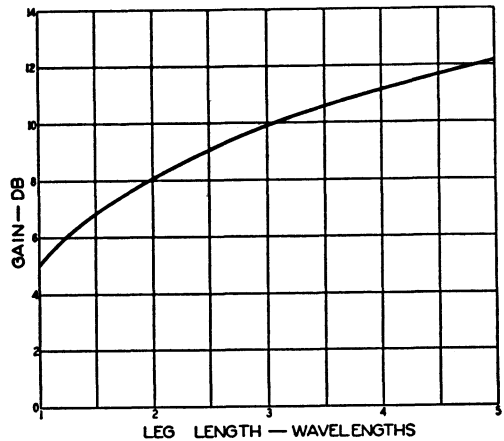

Fig. 5-16 — Theoretical gain of a nonresonant rhombic antenna over a half-wave dipole in free space. This curve includes an allowance of 3 dB for loss in the terminating resistor.

Termination

Although there is no marked difference in the gain obtainable with resonant and nonresonant rhombics of comparable design, the nonresonant antenna has the advantage that over a wide frequency range it presents an essentially resistive and constant load to the transmitter coupling apparatus. In addition, nonresonant operation makes the antenna substantially unidirectional, while the unterminated or resonant rhombic is always bidirectional, although not symmetrically so. In a sense, it can be considered that the power dissipated in the terminating resistor is simply power that would have been radiated in the other direction had the resistor not been there, so the fact that some of the power (about one-third) is used up in heating the resistor does not mean an actual loss in the desired direction.

The characteristic impedance of an ordinary rhombic antenna, looking into the input end, is of the order of 700 to 800 ohms when properly terminated in a resistance at the far end. The terminating resistance required to bring about the matching condition usually is slightly higher than the input impedance because of the loss of energy through radiation by the time the far end is reached. The correct value usually will be found to be of the order of 800 ohms, and should be determined experimentally if the flattest possible antenna is desired. However, for average work a noninductive resistance of 800 ohms can be used with the assurance that the operation will not be far from optimum.

The terminating resistor must be practically a pure resistance at the operating frequencies; that is, its inductance and capacitance should be negligible. Ordinary wire-wound resistors are not suitable because they have far too much inductance and distributed capacitance. Small carbon resistors have satisfactory electrical characteristics but will not dissipate more than a few watts and so cannot be used, except when the transmitter power does not exceed 10 or 20 watts or when the antenna is to be used for reception only. The special resistors designed either for use as "dummy" antennas or for terminating rhombic antennas should be used in other cases. To allow a factor of safety, the total rated power dissipation of the resistor or resistors should be equal to half the power output of the transmitter.

To reduce the effects of stray capacitance it is desirable to use several units, say three, in series even when one alone will safely dissipate the power. The two outer units should be identical and each should have one fourth to one third the total resistance, with the center unit making up the difference. The units should be installed in a weatherproof housing at the end of the antenna to protect them and to permit mounting without mechanical strain. The connecting leads should be short so that little extraneous inductance is introduced.

Alternatively, the terminating resistance may be placed at the end of an 800-ohm line connected to the end of the antenna. This will permit placing the resistors and their housing at a point convenient

for adjustment rather than at the top of the pole. Resistance wire may be used for this line, so that a portion of the power will be dissipated before it reaches the resistive termination, thus permitting the use of lower wattage lumped resistors. The line length is not critical, since it operates without standing waves and hence is nonresonant.

### Multiwire Rhombics

The input impedance of a rhombic antenna constructed as in Fig. 5-12 is not quite constant as the frequency is varied. This is because the varying separation between the wires causes the characteristic impedance of the antenna to vary along its length. The variation in  $Z_0$  can be minimized by a conductor arrangement that increases the capacitance per unit length in proportion to the separation between the wires.

The method of accomplishing this is shown in Fig. 5-17. Three conductors are used, joined together at the ends but with increasing separation as the junction between legs is approached. As used in commercial installations having legs several wavelengths long, the spacing between wires at the center is 3 to 4 feet. Since all three wires should have the same length, the top and bottom wires will be slightly farther from the support than the middle wire. Using three wires in this way reduces the  $Z_0$  of the antenna to approximately 600 ohms, thus providing a better match for a practicable open-wire line, in addition to smoothing out the impedance variations over the frequency range.

A similar effect, although not quite so good, is obtained by using two wires instead of three. It has been found that, with the 3-wire system, the gain of the antenna is slightly greater (of the order of 1 dB) than when only a single conductor is used.

### Front-to-Back Ratio

It is theoretically possible to obtain an infinite front-to-back ratio with a terminated rhombic antenna, and in practice very large values can actually be secured. However, when the antenna is terminated in its characteristic impedance the infinite front-to-back ratio can be secured only at frequencies for which the leg length is an odd multiple of a quarter wavelength, as described in the section on nonresonant long wires. The front-to-back ratio is smallest at frequencies for which the leg length is a multiple of a half wavelength.

When the leg length is not an odd multiple of a quarter wave at the frequency under consideration, the front-to-back ratio can be made very high by slightly decreasing the value of terminating resistance. This permits a small reflection from the far end of the antenna which cancels out, at the input end, the residual response. With large antennas the front-to-back ratio may be made very large over the whole frequency range by experimental adjustment of the terminating resistance. Modification of the terminating resistance can result in a splitting of the back null into two nulls, one on either side of a small lobe in the back direction. Changes in the value of terminating resistance thus permit "steering" the back null over a small horizontal

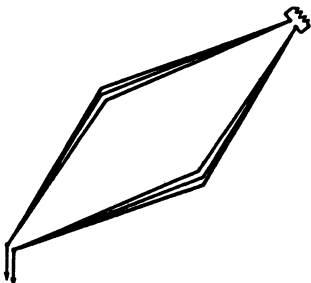

Fig. 5-17 — Three-wire rhombic antenna. Use of multiple wires improves the impedance characteristic of a nonresonant rhombic and increases the gain somewhat.



range so that signals coming from a particular spot not exactly to the rear of the antenna may be minimized.

**Ground Effects**

Reflections from the ground play exactly the same part in determining the vertical directive pattern of a horizontal rhombic antenna that they play with other horizontal antennas. Consequently, if a low wave angle is desired it is necessary to make the height great enough to bring the reflection factor into the higher range of values given by the charts in Chapter Two.

**Alignment of Lobes, Wave Angle, and Ground Reflections**

When maximum antenna response is desired at a particular wave angle (or maximum radiation is desired at that angle) the major lobe of the antenna cannot only be aligned with the wave angle as previously described but also with a maximum in the ground-reflection factor. When this is done it is no longer possible to consider the antenna height independently of other aspects of rhombic design. The wave angle, leg length, and height become mutually dependent.

This method of design is of particular value when the antenna is built to be used over fixed transmission distances for which the optimum wave angle is known. It has had wide application in commercial work with nonresonant rhombic antennas, but seems less desirable for amateur use where, for the long-distance work for which rhombic antennas are built, the lowest wave angle that can be obtained is the most desirable. Alignment of all three factors is limited in application because it leads to impracticable heights and leg lengths for small wave angles. Consequently, when a fairly broad range of low wave angles is the objective it is more satisfactory to design for a low wave angle and simply make the antenna as high as possible.

Fig. 5-18 shows the lowest height at which ground reflections make the radiation maximum at a desired wave angle. It can be used in conjunction with Fig. 5-13 for complete alignment of the antenna. For example, if the desired wave angle is 20 degrees, Fig. 5-18 shows that the height must be 0.75 wavelength. From Fig. 5-13, the optimum leg length is 4.2 wavelengths and the tilt angle is just under 70 degrees. A rhombic antenna so designed will have the maximum possible output that can be obtained at a wave angle of 20 degrees; no other set of dimensions will be as good. However, it will have still greater output at some angle lower than 20 degrees, for the reasons given earlier. When it is desired to make the maximum output of the antenna occur at the 20-degree wave angle, it may be accomplished by using the same height and tilt angle, but with the leg length reduced by 26 percent. Thus for such alignment the leg length should be  $4.2 \times 0.74 = 3.1$  wavelengths. However, the output at the 20-degree wave angle will be smaller than with 4.2-wavelength legs, despite the fact that the smaller antenna has its maximum

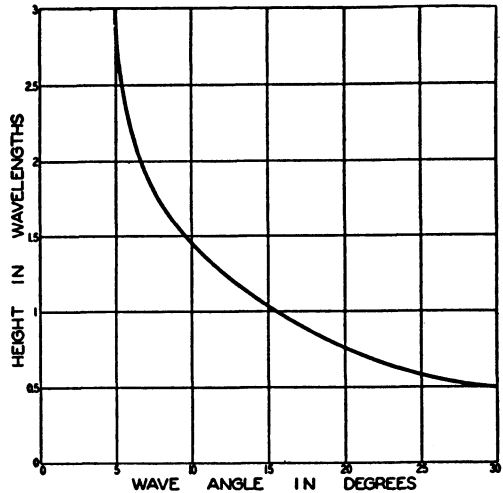

Fig. 5-18 — Antenna height to be used for securing maximum radiation at a desired wave angle. This curve applies to any type of horizontal antenna.

radiation at 20 degrees. The reduction in gain is about 1.5 dB.

**Methods of Feed**

If the broad frequency characteristic of the rhombic antenna is to be fully utilized the feeder system used with it must be similarly broad. This practically dictates the use of a transmission line of the same characteristic impedance as that shown at the antenna input terminals, or approximately 700 to 800 ohms. Data for the construction of such lines will be found in Chapter Three.

While the usual matching stub can be used to provide an impedance transformation to more satisfactory line impedances, this limits the operation of the antenna to a comparatively narrow range of frequencies centering about that for which the stub is adjusted. On the whole, the best plan is to connect a 600-ohm line directly to the antenna and accept the small mismatch which results. The operation of the antenna will not be adversely affected, and since the standing-wave ratio is quite low (1.33 to 1) the additional loss over the perfectly matched condition will be inappreciable even for rather long lines.

**Bibliography**

Source material and more extended discussion of topics covered in this chapter can be found in the references given below.

- Bruce, "Developments in Short-Wave Directive Antennas," *Proc. I.R.E.*, August, 1931.
- Bruce, Beck and Lowry, "Horizontal Rhombic Antennas," *Proc. I.R.E.*, January, 1935.
- Carter, Hansell and Lindenblad, "Development of Directive Transmitting Antennas by R.C.A. Communications," *Proc. I.R.E.*, October, 1931.
- Harper, *Rhombic Antenna Design*, D. Van Nostrand Co., Inc., New York, N. Y.
- Laport, "Design Data for Horizontal Rhombic Antennas," *RCA Review*, March, 1952.

# Multiband Antennas

For operation in a number of bands such as those between 3.5 and 30 MHz it would be impracticable, for most amateurs, to put up a separate antenna for each band. Nor is it necessary; a dipole, cut for the lowest frequency band to be used, readily can be operated on higher frequencies if one is willing to accept the fact that such harmonic-type operation leads to a change in the directional pattern of the antenna (see Chapter Two), and if one is willing to use "tuned" feeders. A center-fed single-wire antenna can be made to accept power and radiate it with high efficiency on any frequency higher than its fundamental resonant frequency and, with some reduction in efficiency and bandwidth, on frequencies as low as one half the fundamental.

In fact, it is not necessary for an antenna to be a full half-wavelength long at the lowest frequency. It has been determined that an antenna can be considerably shorter than a half wavelength, as

much as one-quarter wavelength, and still be a very efficient radiator at the lowest frequency.

In addition, methods have been devised for making a single antenna structure operate on a number of bands while still offering a good match to a transmission line, usually of the coaxial type. It should be understood, however, that a "multiband antenna" is not *necessarily* one that will match a given line on all bands on which it is intended to be used. Even a relatively short whip type of antenna can be operated as a multiband antenna with suitable loading, which may be in the form of a coil at its base on those frequencies where loading is needed, or which may be incorporated in the tuned feeders which run from the transmitter to the base of the antenna.

This chapter describes a number of systems that can be used on two or more bands. Beam antennas are not included, these being treated separately in later chapters.

## DIRECTLY FED ANTENNAS

The simplest multiband antenna is a random length of No. 12 or No. 14 wire. Power can be fed to the wire on practically any frequency by one or the other of the methods shown in Fig. 6-1. If the wire is made either 67 or 135 feet long, it can also be fed through a tuned circuit as in Fig. 6-2. It is advantageous to use an SWR bridge or other indicator in the coax line at the point marked X.

If a 28- or 50-MHz rotary beam has been installed, in many cases it will be possible to use the beam's feed line as an antenna on the lower frequencies. Connecting the two wires of the feeder together at the station end will give a random-length wire that can be conveniently coupled to the transmitter as in Fig. 6-1. The rotary system at the far end will serve only to "end load" the wire and will not have much other effect.

One disadvantage of all such directly fed systems is that part of the antenna is practically within the station, and there is a good chance that trouble with rf feedback will be encountered. The rf within the station can often be minimized by choosing a length of wire so that a *current loop* occurs at or near the transmitter. This means using a wire length of a quarter wavelength (65 feet at 80 meters, 33 feet at 40 meters), or an odd multiple of a quarter wavelength ( $3/4$  wavelength is 195 feet at 80 meters, 100 feet at 40 meters). Obviously

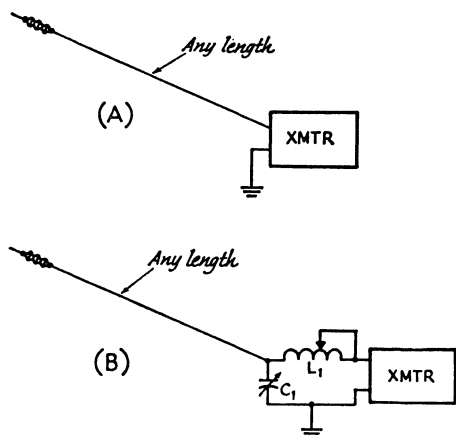

Fig. 6-1 — (A) Random-length wire driven directly from the pi-network output of a transmitter. (B)  $L$  network for use in cases where sufficient loading cannot be obtained with (A).  $C_1$  should have about the same plate spacing as the final tank capacitor; a maximum capacitance of 100 pF is sufficient if  $L_1$  is 20 to 25  $\mu$ H. A suitable coil would consist of 30 turns of No. 12, 2-1/2 inches in diameter, 6 turns per inch. Bare wire should be used so the tap can be placed as required for loading transmitter.

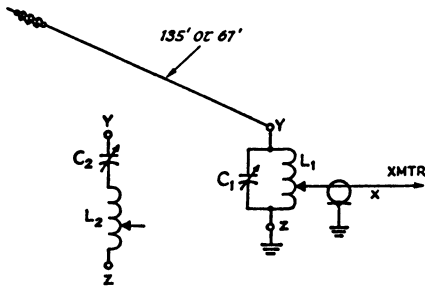

Fig. 6-2 — If the antenna length is 135 feet, a parallel-tuned coupling circuit can be used on each amateur band from 3.5 through 30 MHz. C1 should duplicate the final-tank tuning capacitor and L1 should have the same dimensions as the final-tank inductor on the band being used. If the wire is 67 feet long, series tuning can be used on 3.5 MHz as shown at the left; parallel tuning will be required on 7 MHz and higher frequency bands. C2 and L2 will in general duplicate the final tank tuning capacitor and inductor, the same as with parallel tuning. The L network shown in Fig. 6-1B is also suitable for these antenna lengths.

this can be done for only one band in the case of even harmonically related bands, since the wire length that gives a current loop at the transmitter will give a voltage loop at two (or four) times that frequency.

When operating with a random-wire antenna, as in Figs. 6-1 and 6-2, it is wise to try different types of grounds on the various bands, to see which will give the best results. In many cases it will be satisfactory to return to the transmitter chassis for the ground, or directly to a convenient water pipe. If neither of these works well (or the water pipe is not available), a length of No. 12 or No. 14 wire (approximately 1/4 wavelength long) can often be used to good advantage. Connect the wire at the point in the circuit that is shown grounded, and run it out and down the side of the house, or support it a few feet above the ground if the station is on the first floor or in the basement. It should not be connected to actual ground at any point.

**END-FED ANTENNAS**

When a straight-wire antenna is fed at one end by a two-wire line, the length of the antenna

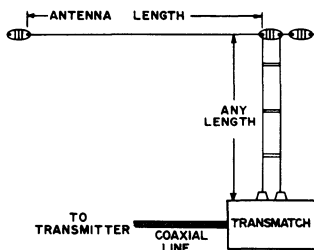

Fig. 6-3 — An end fed antenna for multiband use.

portion becomes fairly critical if radiation from the line is to be held to a minimum. Such an antenna system for multiband operation is the “end-fed” or “Zepp-fed” antenna shown in Fig. 6-3. The antenna length is made a half wavelength at the lowest operating frequency. The feeder length can be anything that is convenient, but feeder lengths that are multiples of a quarter wavelength generally give trouble with parallel currents and radiation from the feeder portion of the system. The feeder can be an open-wire line of No. 14 solid copper wire spaced 4 or 6 inches with ceramic or plastic spacers. Open-wire TV line (not the type with a solid web of dielectric) is a convenient type to use. This type of line is available in approximately 300- and 450-ohm characteristic impedance.

If one has room for only a 67-foot flat top and yet wants to operate in the 3.5-MHz band, the two feeder wires can be tied together at the transmitter end and the entire system treated as a random-length wire fed directly, as in Fig. 6-1.

The simplest insurance against parallel currents which could cause feed-line radiation is to use a feeder length that is not a multiple of a quarter wavelength, e.g., a 40-foot length would be suitable for all amateur frequencies between 3.5 and 30

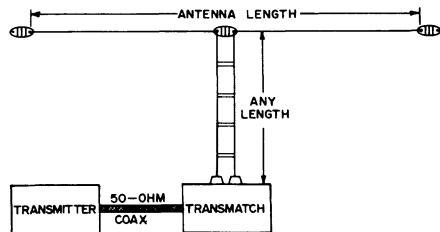

Fig. 6-4 — A center-fed antenna system for multiband use.

MHz. A Transmatch (described in a later section of this chapter) can be used to provide multiband coverage with an end-fed antenna with any length of open-wire feed line, as shown in Fig. 6-3.

**CENTER-FED ANTENNAS**

The simplest and most flexible (and also most inexpensive) all-band antennas are those using open-wire parallel-conductor feeders to the center of the antenna, as in Fig. 6-4. Because each half of the flat top is the same length, the feeder currents will be balanced at all frequencies unless, of course, unbalance is introduced by one half of the antenna being closer to ground (or a grounded object) than the other. For best results and to maintain feed-current balance, the feeder should run away at right angles to the antenna, preferably for at least a quarter wavelength.

Center feed is not only more desirable than end feed because of inherently better balance, but generally also results in a lower standing-wave ratio on the transmission line, provided a parallel-conductor line having a characteristic impedance of 450 to 600 ohms is used. TV-type open-wire line is satisfactory for all but possibly high-power installa-

tions (over 500 watts), where heavier wire and wider spacing is desirable to handle the larger currents and voltages.

The length of the antenna is not critical nor is the length of the line. As mentioned earlier, the length of the antenna can be considerably less than one-half wavelength and still be very effective. If the overall length is at least one-quarter wavelength at the lowest frequency, a quite usable system will result. The only difficulty that may exist with this type of system is the matter of coupling the antenna-system load to the transmitter. Most modern transmitters are designed to work into a 50- to 70-ohm coaxial load. With this type of antenna system a coupling network such as a Transmatch is required.

### FEED-LINE RADIATION

The preceding sections have pointed out means of reducing or eliminating feed-line radiation. However, it should be emphasized that any radiation from a transmission line is not "lost" energy and is not necessarily harmful. Whether or not feed-line radiation is important depends entirely on the antenna system being used. For example, feed-line radiation is *not* desirable when a directive array is being used. Such radiation can distort the desired pattern of such an array, producing responses in unwanted directions. In other words, one wants radiation *only* from the directive array.

On the other hand, in the case of a multiband dipole where general coverage is desired, if the feed line happens to radiate, such energy could actually have a desirable effect. Antenna purists may dispute such a premise, but from a practical standpoint where one is not concerned with a directive pattern, much time and labor can be saved by ignoring possible transmission-line radiation.

### FEEDER-TO-TRANSMITTER MATCHING NETWORKS

The Transmatch shown in Figs. 6-5, 6-6, and 6-7 is designed to handle practically any mismatch

that an amateur is likely to encounter. The unit can be used with either open-wire feeders, balanced lines, coaxial lines, or even an end-fed single wire. Frequency range of the unit is from 3 to 30 MHz, accomplished without the use of bandswitching. Basically, the circuit is designed for use with unbalanced lines, such as coax. For balanced lines, a 1:4 (unbalanced-to-balanced) balun, Fig. 6-8, is connected to the output of the Transmatch.

The chassis used for the Transmatch is made of a 16 × 25-inch sheet of aluminum. When bent to form a U, the completed chassis measures 16 × 13 × 6 inches. When mounting the variable capacitors, the roller inductor and the balun, allow at least 1/2-inch clearance to the chassis and adjoining components. The capacitors should be mounted on standoff insulators. The balun can be mounted on a cone insulator or piece of Plexiglas.

Amidon type T-200-2 cores are used in making the balun. The balun requires three ferrite cores stacked for 2-kW or two cores for 1-kW power levels. Each core should be covered with two layers of 3M No. 27 glass-cloth insulating tape. Next, the cores are stacked and covered with another layer of the tape. The winding consists of 13 bifilar turns of No. 14 or No. 16 Teflon-covered wire. Approximately 20 feet of wire (two 10-foot lengths) are required.

An SWR indicator is necessary for adjusting the Transmatch during operation. Construction of such indicators is described in Chapter Seventeen. In the Transmatch pictured (Fig. 6-6), an indicator is built into the enclosure.

For coax-to-coax feeder matching, the antenna feed line should be connected to J2, Fig. 6-7. C1 and C2 should be set at maximum capacitance and power applied to the transmitter. The SWR indicator should be switched to read reflected power. Then adjust L3 until there is a drop in the reflected reading. C1 and C2 should then be reset, along with L3, until a perfect match is obtained. It will be found that with many antenna systems, several different matching combinations can be obtained. Always use the matching setting that uses the most capacitance from C1 and C2, as

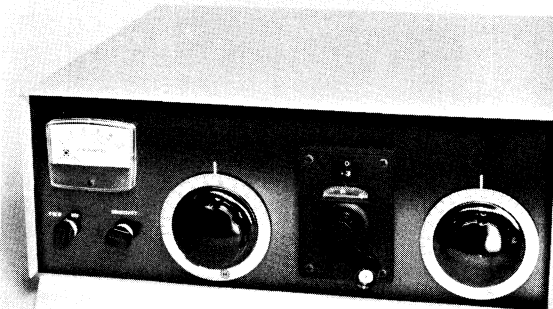
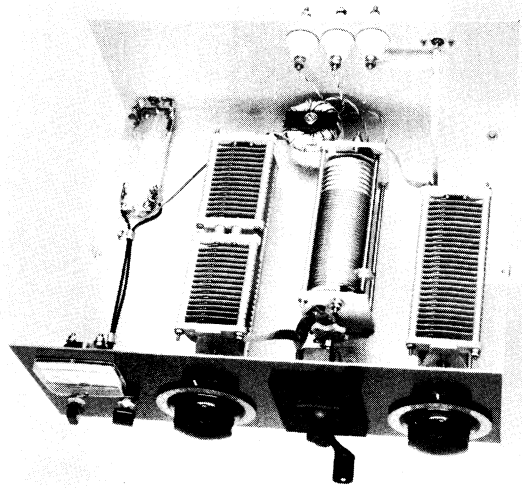

Fig. 6-5 — The universal Transmatch shown here will couple a transmitter to almost any antenna system. The meter is part of an optional built-in SWR indicator. Suitable indicators for inclusion, if the builder desires, are given in Chapter Seventeen.

Fig. 6-6 — Interior view of the Transmatch. Both C1 and C2 must be mounted on insulated standoffs and insulated shaft couplers used between the capacitors and the panel knobs. Likewise, T1 should be installed on an insulated mounting. An isolantite cone is used in the unit shown (the balun could be mounted on a piece of Plexiglas). Feedthrough isolantite insulators, mounted through the rear deck, are used for the antenna connectors. The components at the left are those of the SWR indicator.



maximum *C* provides the best harmonic attenuation.

End-fed wires should be connected to J3. Use the same adjustment procedures for setting up the Transmatch as outlined above. For balanced feeders, the feed line should be connected to J4 and J5, and a jumper must be connected between J3 and J4 (see Fig. 6-7 at C).

A slight modification will permit this Transmatch to be used on the 160-meter band. Fixed capacitors, 100 pF each (Centralab type 850S-100N), can be installed across each of the stator sections of C1, providing sufficient *C* to tune to 1.8 MHz. But, the fixed capacitors must be removed when using the Transmatch on the hf bands.

**Commercial Matching Networks**

The Transmatch shown in Fig. 6-7 will match any antenna system. However, some commercial types have limited matching ranges and amateurs encounter problems in matching multiband systems. As an example, one such unit, which is very popular in amateur use, is the Johnson Matchbox.

The Matchbox uses a very efficient circuit but has limited matching ranges. The 250-watt version will match loads from approximately 12 ohms to 2500 ohms, and the kilowatt unit will handle loads from 25 to 1200 ohms, 80 through 10 meters. Many antenna systems present loads which fall outside these ranges and the Matchbox will not

handle them. However, any antenna system can be modified, quite simply, to put the system within the matching limits of the Matchbox.

When one installs a multiband antenna system of any type, a complex load may exist at the input end of the feed line. Depending on the frequency in use and the line length, this load can be very high or very low impedance, or anywhere in between. If the impedance happens to be outside the range of the Matchbox, it will be impossible to obtain a match. Changing the feed-line length will change the line input impedance, and thus may bring it into the range of the Matchbox. The goal is to obtain a length that will put the antenna system within the matching range of the unit. If, for example, one finds that a match is possible on 80 meters but not on 40, add or remove some feed line and recheck the matching on both bands. It is possible with experimentation to find a feed-line length that will provide a match on most bands.

If it is inconvenient to alter the length of the feeder, a match may still be obtained in most cases

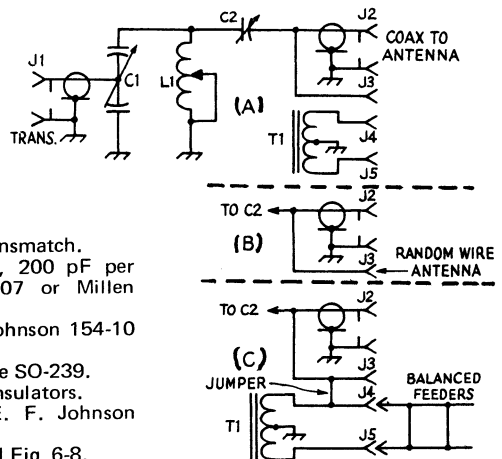

Fig. 6-7 — Circuit diagram of the Transmatch.  
 C1 — Dual-section or air variable, 200 pF per section (E. F. Johnson 154-507 or Millen 16250).  
 C2 — Air variable 350 pF, (E. F. Johnson 154-10 or Millen 16520A).  
 J1, J2 — Coax chassis connector, type SO-239.  
 J3, J4, J5 — Isolantite feedthrough insulators.  
 L1 — Roller inductor, 28 μH (E. F. Johnson 229-203).  
 T1 — Balun transformer; see text and Fig. 6-8.

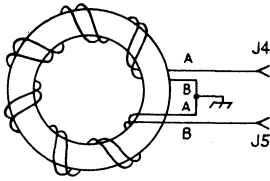

Fig. 6-8 — Details of the balun bifilar windings for the Transmatch. The drawing shows the connectors required. In the actual balun, the turns should be close spaced on the inside of the core and spread evenly on the outside.

by connecting a lumped-value reactance directly across the line-input terminals, at the point where they are connected to the matching network. Quite often the line-input impedance will contain a high-value reactive component, either inductive or capacitive, along with the resistive component. Connecting a reactance of the opposite type and proper value will cancel the high reactance, and may thereby put the resultant impedance within the matching range of the network. The type and value of the reactance for each amateur band must be determined experimentally. Since pure reactances consume no power, efficiency of the antenna system will be affected only by the losses in the reactive components. Therefore, high-*Q* coils and low-loss capacitors, such as transmitting mica or ceramic types, are preferred. Quite high rf voltages may be developed across these added components, so they should be selected and connected with this possibility in mind.

**OFF-CENTER FEED — THE “WINDOM” ANTENNA**

A multiband antenna that enjoyed considerable popularity in the 1930s is the “off-center feed” or “Windom,” named after the amateur who wrote a comprehensive article about it. Shown in Fig. 6-9A, it consists of a half-wavelength antenna on the lowest-frequency band to be used, with a *single-wire* feeder connected off center as shown. The antenna will operate satisfactorily on the even-harmonic frequencies, and thus a single antenna can be made to serve on the 80-, 40-, 20- and 10-meter bands. The single-wire feeder shows an impedance of approximately 600 ohms to ground, and since the return circuit for the feed system is through the earth, a good ground connection is important to the effective operation of the antenna. Also, the system works best when installed over ground having high conductivity.

Theoretically the single-wire feeder can be any convenient length, since its characteristic impedance is matched by the antenna impedance at the point where the feeder is connected. However, this type of feeder is susceptible to parallel-type currents just as much as the two-conductor type (see Chapter Three), and some feeder lengths will lead to “rf in the shack” troubles, especially when the feeder goes directly to a pi network in the transmitter. Adding or subtracting 1/8 wavelength

or so of line usually will help cool things off in such cases.

A newer version of the off-center-fed antenna (miscalled “Windom”) uses 300-ohm TV Twin-Lead instead of a single-wire line. This system is shown in Fig. 6-9B. The claim has been made that the 300-ohm line is matched by the antenna impedance at the connection point both on the antenna’s fundamental frequency and on harmonics, but there is little theoretical justification for this. The system is particularly susceptible to parallel line currents because of the unsymmetrical feeder connection, and probably in many cases the line acts more like a single-wire feeder than a parallel-conductor one. The parallel currents on the line can be choked off by using balun coils (see

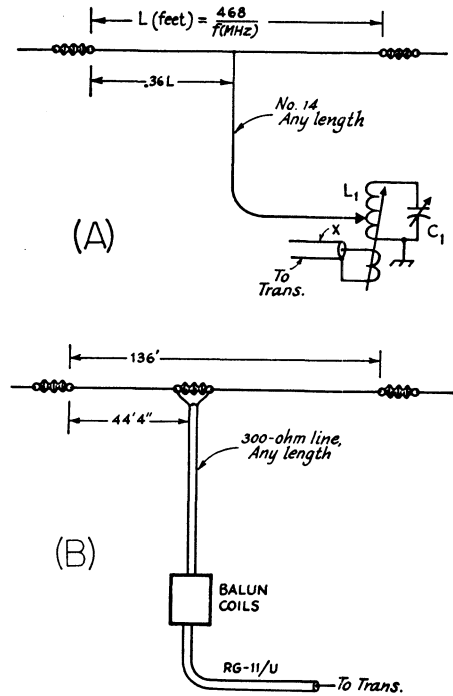
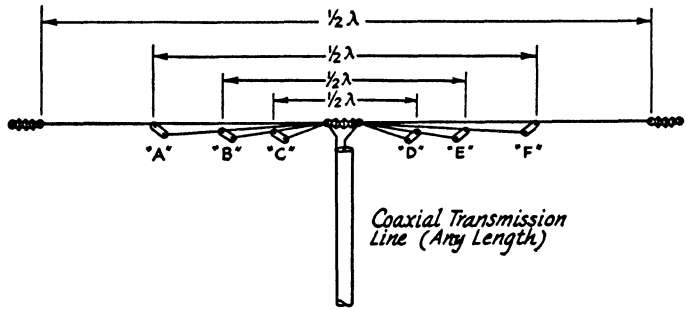

Fig. 6-9 — Two versions of the off-center-fed antenna. (A) Single-wire feed. The single-wire feeder can be connected directly to the “hot” output terminal of a pi network in the transmitter. Alternatively, the link-coupled circuit shown may be used with a separate ground connection as indicated; this type of coupling helps reduce troubles from rf currents on the station equipment. The matching circuit described earlier in this chapter also can be used, with unbalanced output. Both circuits should be adjusted as described for the tapped matching circuit. (B) Two-wire feed, using 300-ohm TV line. The balun coils may be omitted and the 300-ohm line connected directly to the output terminals of a pi network in the transmitter, but this is not recommended because it leads to rf troubles of the type described in the text. The matching circuit shown earlier in this chapter may be substituted for the balun coils if desired.

Fig. 6-10 — Multiband antenna using paralleled dipoles all connected to a common low-impedance transmission line. The half-wave dimensions may be either for the centers of the various bands or selected to fit favorite frequencies in each band. Length of half wave in feet is  $468/\text{frequency in MHz}$ .



Chapter Three) as shown in Fig. 6-9B. The same balun will transform the impedance to 75 ohms, in cases where the line actually shows a resistive input impedance of 300 ohms.

With either of the off-center-fed systems the feeder should be brought away from the antenna at right-angles for at least a quarter wavelength before any bends are made. Any necessary bends should be made gradually.

**MULTIPLE-DIPOLE ANTENNAS**

The antenna system shown in Fig. 6-10 consists of a group of center-fed dipoles all connected in parallel at the point where the transmission line joins them. One such dipole is used for each band on which it is desired to work, and as many as four have been used, as indicated in the sketch. It is not generally necessary to provide a separate dipole for the 21-MHz band since a 7-MHz dipole works satisfactorily as a third-harmonic antenna on this band.

Although there is some interaction between the dipoles it has been found in practice that the ones that are not resonant at the frequency actually applied to the antenna have only a small effect on the feed-point impedance of the "active" dipole. This impedance is therefore approximately that of a single dipole, or in the neighborhood of 60-70 ohms, and the system can be fed through a 50- or 75-ohm line with a satisfactorily low standing-wave ratio on the line.

Since the antenna system is balanced, it is desirable to use a balanced transmission line to feed it. The most desirable type of line is 75-ohm solid-dielectric Twin-Lead. The transmitting variety of line should be used, since the 75-ohm receiving-type line has rather high loss, even when matched. However, either 52-ohm or 75-ohm coaxial line can be used; coax line introduces some unbalance, but this is not intolerable on the lower frequencies.

The separation between the dipoles for the various frequencies does not seem to be especially critical, so far as experience indicates. One set of wires can be suspended from the next larger set, using insulating spreaders (of the type used for feeder spreaders) to give a separation of a few inches.

An interesting method of construction used successfully by ON4UF is shown in Fig. 6-11. The antenna has four dipoles (for 7, 14, 21 and 28 MHz) constructed from 300-ohm ribbon transmission line. A single length of ribbon makes two

dipoles. Thus, two lengths, as shown in the sketch, serve to make dipoles for four bands. Ribbon with copper-clad steel conductors (Amphenol type 14-022) should be used because all of the weight, including that of the feed line, must be supported by the uppermost wire.

Two pieces of ribbon are first cut to a length suitable for the two halves of the longest dipole. Then one of the conductors in each piece is cut to proper length for the next band higher in frequency. The excess wire and insulation is stripped away. A second pair of lengths is prepared in the same manner, except that the lengths are appropriate for the next two higher frequency bands.

A piece of thick polystyrene sheet drilled with holes for anchoring each wire serves as the central insulator. The shorter pair of dipoles is suspended the width of the ribbon below the longer pair by clamps also made of poly sheet. Intermediate spacers are made by sawing slots in pieces of poly sheet so that they will fit the ribbon snugly.

Dimensions, as determined by use of a grid-dip oscillator, are shown in Table 6-1. The system showed an impedance of close to 70 ohms on all bands, and the SWR on a 75-ohm line was low and nearly constant. However, 50-ohm-impedance cable can be used with only a slight difference in SWR.

**TABLE 6-1**

**Twin-Lead Parallel-Dipole Antenna Dimensions**

Frequency (MHz)	Length Each Half		
	Meters	Feet	In.
7.1	9.95	32	8
14.1	4.60	15	1
21.2	3.44	11	3
28.2	2.34	7	8

**TRAP DIPOLES**

By using tuned circuits of appropriate design strategically placed in a dipole, the antenna can be made to show what is essentially fundamental resonance at a number of different frequencies. The general principle is illustrated by Fig. 6-12. The two inner lengths of wire, X, together form a simple dipole resonant at the highest band desired, say 14 MHz. The tuned circuits L1-C1 are also resonant at this frequency, and when connected as shown offer a very high impedance to rf current of that frequency which may be flowing in the

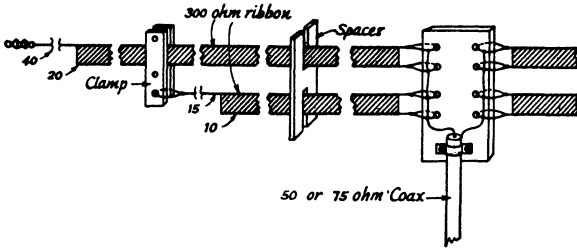

Fig. 6-11 — Sketch showing how the Twin-Lead multiple-dipole antenna system is assembled. The excess wire and insulation are stripped away.

section X-X. Effectively, therefore, these two tuned circuits act as insulators for the inner dipole, and the outer sections beyond L1-C1 are inactive.

However, on the next lower frequency band, say 7 MHz, L1-C1 shows an inductive reactance and is the electrical equivalent of a coil. If the two sections marked Y are now added and their length adjusted so that, together with the loading coils represented by the inductive reactance of L1-C1, the system out to the ends of the Y sections is resonant at 7 MHz. This part of the antenna is equivalent to a loaded dipole on 7 MHz and will exhibit about the same impedance at the feed point as a simple dipole for that band. The tuned circuit L2-C2 is resonant at 7 MHz and acts as a high impedance for this frequency, so the 7-MHz dipole is in turn insulated, for all practical purposes, from the remaining outer parts of the antenna.

Carrying the same reasoning one step farther, L2-C2 shows inductive reactance on the next lower frequency band, 3.5 MHz, and is equivalent to a coil on that band. The length of the added sections, Z-Z, is adjusted so that, together with the two sets of equivalent loading coils now indicated in C, the whole system is resonant as a loaded dipole on 3.5 MHz. A single transmission line

having a characteristic impedance of the same order as the feed-point impedance of a simple dipole can be connected at the center of the antenna and will be satisfactorily matched on all three bands, and so will operate at a low SWR on all three. A line of 75-ohm impedance is satisfactory; coax may be used, but Twin-Lead will maintain better balance in the system since the antenna itself is symmetrical.

**Trap Losses**

Since the tuned circuits have some inherent losses the efficiency of this system depends on the Qs of the tuned circuits. Low-loss (high-Q) coils should be used, and the capacitor losses likewise should be kept as low as possible. With tuned circuits that are good in this respect — comparable with the low-loss components used in transmitter tank circuits, for example — the reduction in efficiency as compared with the efficiency of a simple dipole is small, but tuned circuits of low Q can lose an appreciable portion of the power supplied to the antenna.

**Dimensions**

The lengths of the added antenna sections, Y and Z in the example, must in general be deter-

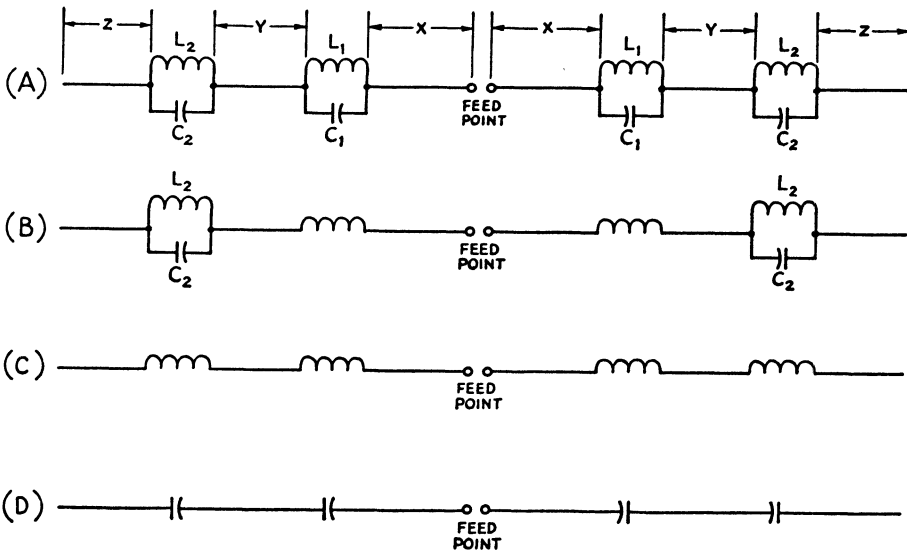

Fig. 6-12 — Development of the "trap" dipole for operation on fundamental-type resonance in several bands.



mined experimentally. The length required for resonance in a given band depends on the length/diameter ratio of the antenna conductor and on the  $L/C$  ratio of the trap acting as a loading coil. The effective reactance of an  $LC$  circuit on half the frequency to which it is resonant is equal to  $2/3$  the reactance of the inductance at the resonant frequency. For example, if L1-C1 resonates at 14 MHz and L1 has a reactance of 300 ohms at 14 MHz, the inductive reactance of the circuit at 7 MHz will be equal to  $2/3 \times 300 = 200$  ohms. The added antenna section,  $Y$ , would have to be cut to the proper length to resonate at 7 MHz with this amount of loading. Since any reasonable  $L/C$  ratio can be used in the trap without affecting its performance materially at its resonant frequency, the  $L/C$  ratio can be varied to control the added antenna length required. The added section will be shorter with high- $L$  trap circuits and longer with high- $C$  traps.

### Higher Frequencies

On bands higher than that for which the inner dipole is resonant all traps in the system show capacitive reactance. Thus at such frequencies the antenna has the equivalent circuit shown at D in Fig. 6-12. The capacitive reactances have the effect of raising the resonant frequency of the system as compared with a simple dipole of the same overall length.

This effect is greatest near the resonant frequency of the inner dipole  $X-X$  and becomes less marked as the frequency is increased, since the capacitive reactance decreases with increasing frequency. The system therefore can be used on higher frequency bands as a harmonic-type antenna, but obtaining resonance with low impedance will require careful balancing of the trap  $L/C$  ratios and the lengths of the various antenna sections.

### Five-Band Antenna

One such system has been worked out by W3DZZ for the five amateur bands from 3.5 to 30 MHz. Dimensions are given in Fig. 6-13. Only one set of traps is used, resonant at 7 MHz to isolate the inner (7-MHz) dipole from the outer sections, which cause the overall system to be resonant in the 3.5-MHz band. On 14, 21 and 28 MHz the antenna works on the capacitive-reactance principle just outlined. Using 75-ohm Twin-Lead as a feeder, the SWR with this antenna was under 2 to 1 throughout the three high-frequency bands, and the SWR was comparable with that obtained with similarly fed simple dipoles on 7 and 3.5 MHz.

### Trap Construction

Traps frequently are built with coaxial aluminum tubes (usually with polystyrene tubing between them for insulation) for the capacitor, and with the coil either self-supporting or wound on a form of larger diameter than the tubular capacitor. The coil is then mounted coaxially with the capacitor to form a unit assembly that can be supported at each end by the antenna wires. In

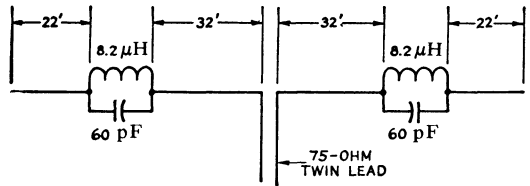

Fig. 6-13 — Five-band (3.5 through 28 MHz) trap dipole for operation with 75-ohm feeder at low SWR (W3DZZ). The balanced (parallel-conductor) line indicated is desirable, but 75-ohm coax can be substituted with some sacrifice of symmetry in the system. Dimensions given are for resonance (lowest SWR) at 3750, 7200, 14,150, and 29,500 kHz. Resonance is very broad on the 21-MHz band, with SWR less than 2:1 throughout the band.

another type of trap devised by Lattin (see bibliography at the end of this chapter), the coil is supported *inside* an aluminum tube, and the trap capacitor is obtained in the form of capacitance between the coil and the outer tube. This type of trap is inherently weatherproof.

A simpler type of trap, easily assembled from readily available components, is shown in Fig. 6-14. A small transmitting-type ceramic capacitor is used, together with a length of commercially available coil material, these being supported by an ordinary antenna strain insulator. The circuit constants and antenna dimensions differ slightly from those of Fig. 6-13, in order to bring the antenna resonance points closer to the centers of the various phone bands. Construction data are given in Fig. 6-15. If a 10-turn length of inductor is used, a half turn from each end may be used to slip through the anchor holes in the insulator to act as leads.

The components used in these traps are sufficiently weatherproof in themselves so that no additional treatment for this purpose has been

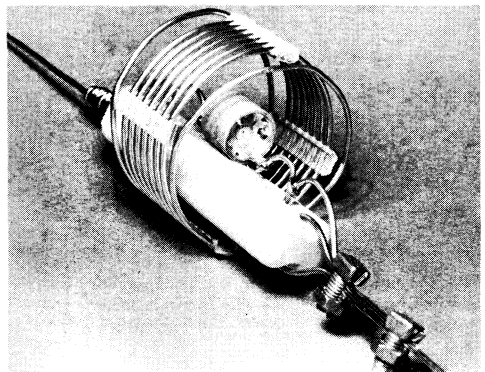

Fig. 6-14 — Easily constructed trap for wire antennas (W2CYK). The ceramic insulator is 4-1/4 inches long (Birnbach 668). The clamps are small service connectors available from electrical supply and hardware stores (Burndy KS90 Servits).

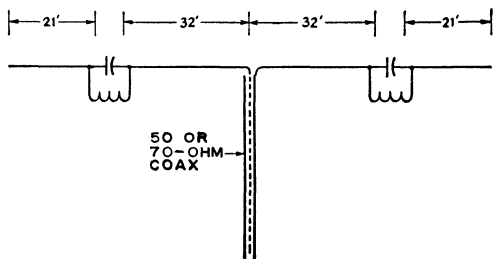

Fig. 6-15 — Layout of multiband antenna using traps constructed as shown in Fig. 6-14. The capacitors are 100 pF each, transmitting type, 5000-volt dc rating (Centralab 850SL-100N). Coils are 9 turns No. 12, 2-1/2 inch diameter, 6 turns per inch (B&W 3029) with end turns spread as necessary to resonate the traps to 7200 kHz. These traps, with the wire dimensions shown, resonate the antenna at approximately the following frequencies on each band: 3900, 7250, 14,100, 21,500 and 29,900 kHz (based on measurements by W9YJH).

found to be necessary. However, if it is desired to protect them from the accumulation of snow or ice a plastic cover can be made by cutting two disks of polystyrene slightly larger in diameter than the coil, drilling at the center to pass the antenna wires, and cementing a plastic cylinder on the edges of the disks. The cylinder can be made by wrapping two turns or so of .02-inch poly or Lucite sheet around the disks, if no suitable ready-made tubing is available.

#### Four-Band Trap Dipole

In case there is not enough room available for erecting the 100-odd-foot length required for the five-band antennas just described, Fig. 6-16 shows a four-band dipole operating on the same principle that requires only half the linear space. The trap construction is the same as shown in Fig. 6-14. With the dimensions given in Fig. 6-16 the resonance points are 7200, 14,100, 21,150 and 28,400 kHz. The capacitors are 27-pF transmitting-type ceramic (Centralab type 857). The inductors are 9 turns of No. 12, 2-1/2 inches in diameter, 6 turns per inch (B&W 3029), adjusted so that the trap resonates at 14,100 kHz before installation in the antenna.

#### Vertical Antennas

There are two basic types of vertical antennas and either type can be used in multiband configurations. The first is the ground-mounted vertical

and the second, the ground plane. These antennas are described in detail in Chapter Two.

The efficiency of any ground-mounted vertical depends a great deal on earth losses. As pointed out in Chapter Two, these losses can be reduced or eliminated with an adequate radial system. Considerable experimentation has been conducted on this subject by Sevick, and several important results were obtained. It was determined that a radial system consisting of 40 to 50 radials, two-tenths wavelength long, would reduce the earth losses to about 2 ohms when a quarter-wave radiator was being used. These radials should be on the earth's surface, or if buried, placed not more than an inch or so below ground. Otherwise, the rf current would have to travel through the lossy earth before reaching the radials. In a multiband vertical system, the radials should be 0.2 wavelength long for the lowest band, i.e., 55 feet long for 80-meter operation. Any wire size may be used for the radials. The radials should fan out in a circle, radiating from the base of the antenna. A metal plate, such a piece of sheet copper, can be used at the center connection.

The other common type of vertical is the ground-plane antenna. Normally, this antenna is mounted above ground with the radials fanning out from the base of the antenna. The vertical portion of the antenna is usually an electrical quarter wavelength, as is each of the radials. In this type of antenna, the system of radials acts somewhat like an rf choke, to prevent rf currents from flowing in the supporting structure, so the number of radials is not as important a factor as it is with a ground-mounted vertical system. From a practical standpoint, the customary number of radials is four or five. In a multiband configuration, quarter-wave radials are required for each band of operation with the ground-plane antenna. This is not so with the ground-mounted antenna, where the ground plane is relied upon to provide an image of the radiating section. In the latter case, as long as the ground-screen radials are approximately 0.2 wavelength long at the lowest frequency, this length will be more than adequate for the higher bands.

#### SHORT VERTICAL ANTENNAS

A short vertical antenna can be operated on several bands by loading it at the base, the general arrangement being similar to Figs. 6-1 and 6-2. That is, for multiband work the vertical can be handled by the same methods that are used for random-length wires.

However, a vertical antenna should not be longer than about 3/4 wavelength at the highest frequency to be used, if low-angle radiation is wanted. If the antenna is to be used on 28 MHz

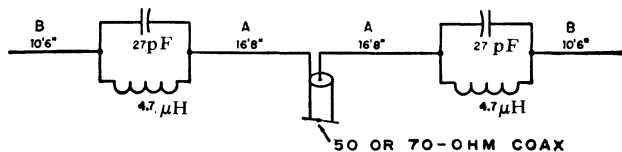

Fig. 6-16 — Sketch showing dimensions of a trap dipole covering the 40- through 10-meter bands (K2GU).

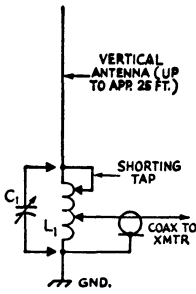

Fig. 6-17 — Multiband vertical antenna system using base loading for resonating on 10 to 80 meters. L1 should be wound with bare wire so it can be tapped at every turn, using No. 12 wire. A convenient size is 2-1/2 inches in diameter, 6 turns per inch (such as B&W 3029). Number of turns required depends on antenna and ground lead length, more turns being required as the antenna and ground lead are made shorter. For a 25-foot antenna and a ground lead of the order of 5 feet, L1 should have about 30 turns. The use of C1 is explained in the text. The smallest capacitance that will permit matching the coax cable should be used; a maximum capacitance of 100 to 150 pF will be sufficient in any case.

and lower frequencies, therefore, it should not be more than approximately 25 feet high, and the shortest possible ground lead should be used. If the base of the antenna is well above actual ground, the ground lead should run to the nearest water or heating pipe.

Another method of feeding is shown in Fig. 6-17. L1 is a loading coil of adjustable inductance so the antenna can be tuned to resonate on the desired band. It is tapped for adjustment of tuning, and a second tap permits using the coil as a transformer for matching a coax line to the transmitter. Capacitor C1 is not strictly necessary, but may be helpful on the lower frequencies, 3.5 and 7 MHz, if the antenna is quite short. In that case C1 makes it possible to tune to resonance with a coil of reasonable dimensions at L1. C1 may also be useful on other bands as well, if the system cannot be matched to the feed line with a coil alone.

The coil and capacitor preferably should be installed at the base of the antenna, but if this cannot be done a wire can be run from the antenna base to the nearest convenient location for mount-

ing L1 and C1. The extra wire will of course be a part of the antenna, and since it may have to run through unfavorable surroundings it is best to avoid its use if at all possible.

This system is best adjusted with the help of an SWR indicator. Connect the coax line across a few turns of L1 and take a trial position of the shorting tap until the SWR reaches its lowest value. Then vary the line tap similarly; this should bring the SWR down to a low value. Small adjustments of both taps then should reduce the SWR to close to 1 to 1. If not, try adding C1 and go through the same procedure, varying C1 each time a tap position is changed.

**Trap Verticals**

The trap principle described in Fig. 6-12 for center-fed dipoles also can be used for vertical antennas. There are two principal differences: Only one half of the dipole is used, the ground connection taking the place of the missing half, and the feed-point impedance is one half the feed-point impedance of a dipole. Thus it is in the vicinity of 30 ohms (plus the ground-connection resistance), so 52-ohm cable should be used since it is the commonly available type that comes closest to matching.

As in the case of any vertical antenna, a good ground is essential, and the ground lead should be short. Some amateurs have reported successfully using a ground plane dimensioned for the lowest frequency to be used; for example, if the lowest frequency is 7 MHz, the ground-plane radials can be approximately 34 feet long.

Traps of the type shown in Fig. 6-14 can be used in a vertical wire suspended from a support, but a trap similar in construction to the loading coil of Fig. 10-14 should be used in tubing verticals.

**Combining Vertical and Horizontal Conductors**

The performance of vertical antennas such as just described depends a great deal on the ground connection. You have no way of knowing whether or not you have a "good" ground, in the rf sense. If you can eliminate the ground connection as a part of the antenna system, it simplifies things. Fig. 6-18 shows how it can be done. Instead of a ground, the system is completed by a wire — preferably, but not necessarily, horizontal — of the same length as the antenna. This makes a balanced system somewhat like the center-fed dipole.

Fig. 6-18 — Vertical and horizontal conductors combined. This system can be used on all bands from 3.5 to 28 MHz with good results.

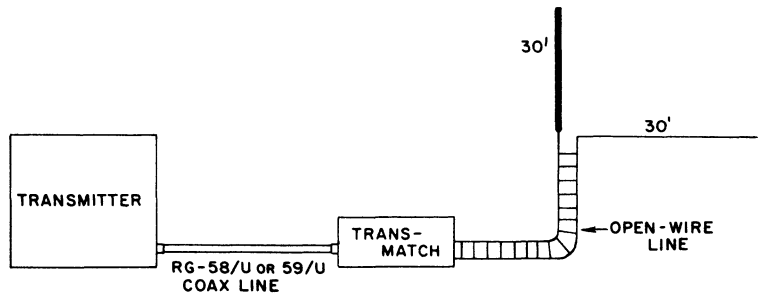

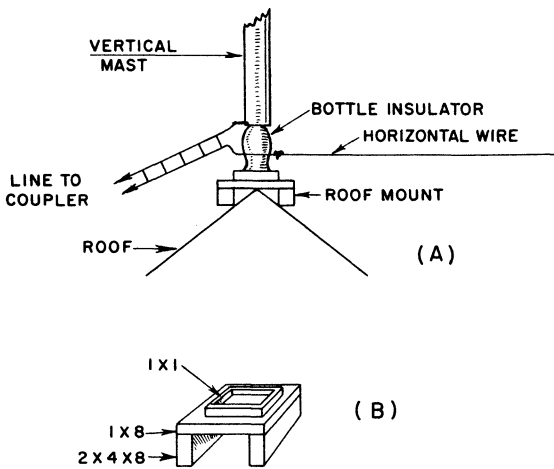

Fig. 6-19 — One method of mounting the vertical section on a rooftop. The mounting base dimensions can be adjusted to fit the pitch of the roof. The 1 × 1 pieces should fit snugly around the bottom of the bottle to keep it from shifting position.

It is desirable that the length of each conductor be of the order of 30 feet, as shown in the drawing, if the 3.5-MHz band is to be used. At 7 MHz, this length doesn't really represent a compromise, since it is almost a half wavelength on that band. Because the shape of the antenna differs from that of a regular half-wave dipole, the radiation characteristics will be different, but the efficiency will be high on 7 MHz and higher frequencies. Although the radiating part is only about a quarter wavelength at 3.5 MHz the efficiency on this band, too, will be higher than it would be with a grounded system. If one is not interested in 3.5 MHz and can't use the dimensions shown, the lengths can be reduced. Fifteen feet in both the vertical and horizontal conductors will not do too badly on 7 MHz and will not be greatly handicapped, as compared with a half-wave dipole, on 14 MHz and higher.

The vertical part can be mounted in a number of ways. However, if it can be put on the roof of your house, the extra height will be worthwhile. Fig. 6-19 suggests a simple base mounting using a soft-drink bottle as an insulator. Get one with a neck diameter that will fit into the tubing used for the vertical part of the antenna. To help prevent possible breakage, put a piece of some elastic material such as rubber sheet around the bottle where the tubing rests on it.

The wire conductor doesn't actually have to be horizontal. It can be at practically any angle that will let you pull it off in a straight line to a point where it can be secured. Use an insulator at this point, of course.

TV ladder line should be used for the feeder in this system. On most bands the standing-wave ratio will be high, and you will lose a good deal of power

in the line if you try to use coax, or even 300-ohm Twin-Lead.

This system can be tuned up by using an SWR indicator in the coax line between the transmitter and a Transmatch.

## HARMONIC RADIATION FROM MULTIBAND ANTENNAS

Since a multiband antenna is intentionally designed for operation on a number of different frequencies, any harmonics or spurious frequencies that happen to coincide with one of the antenna's resonant frequencies will be radiated with very little, if any, attenuation. Particular care should be exercised, therefore, to prevent such harmonics from reaching the antenna.

Multiband antennas using tuned feeders have a certain inherent amount of built-in protection against such radiation since it is nearly always necessary to use a tuned coupling circuit between the transmitter and the feeder. This adds considerable selectivity to the system and helps to discriminate against all frequencies other than the desired one.

Multiple dipoles and trap antennas do not have this feature, since the objective in design is to make the antenna show as nearly as possible the same resistive impedance in all the amateur bands the antenna is intended to cover. It is advisable to conduct tests with other amateur stations to determine whether harmonics of the transmitting frequency can be heard at a distance of, say, a mile or so. If they can, more selectivity should be added to the system since a harmonic that is heard locally, even if weak, may be quite strong at a distance because of propagation vagaries. A Transmatch circuit of the type described earlier in this chapter will add enough selectivity to take care of harmonics of the strength generated by transmitters of good design and construction.

## Bibliography

Source material and more extended discussion of topics covered in this chapter can be found in the references given below.

- Bell, "Trap Collinear Antenna," *QST*, Aug., 1963.
- Berg, "Multiband Operation with Parallelled Dipoles," *QST*, July, 1956.
- Buchanan, "The Multimatch Antenna System," *QST*, March, 1955.
- Greenberg, "Simple Trap Construction for the Multiband Antenna," *QST*, October, 1956.
- Lattin, "Multiband Antennas Using Decoupling Stubs," *QST*, Dec., 1960.
- Lattin, "Antenna Traps of Spiral Delay Line," *QST*, November, 1972.
- Richard, "Parallel Dipoles of 300-Ohm Ribbon," *QST*, March, 1957.
- Sevick, "The W2FMI Ground-Mounted Short Vertical," *QST*, March, 1973.
- Shafer, "Four-Band Dipole with Traps," *QST*, October, 1958.
- Wrigley, "Impedance Characteristics of Harmonic Antennas," *QST*, February, 1954.

# Antennas for 1.8 MHz

Any of the antennas or arrays commonly used on the higher frequencies are suitable for the 1.8-MHz band. However, practical considerations with regard to height and size usually limit the selection to a few basic types. These are the dipole, vertical wire, end-fed wire, loop, and various combinations of these four. Further compromises are often necessary since even these antennas are still quite large. As the size and height decrease, so does the radiating effectiveness, and particular care should be taken to reduce undesired losses to a minimum. The most significant losses result from induced ground currents, conductor resistance, losses in matching networks and loading coils, and absorption of rf energy by surrounding objects. The type of antenna installation finally selected is often dictated by those losses most easily eliminated. For example, vertical antennas are usually considered the most desirable ones to use on 1.8 MHz but if a suitable ground system is not feasible the ground losses will be very high. In such a case, an ordinary dipole may give superior performance even though the angle of maximum radiation is further from optimum than that of a vertical. Some experimentation is often necessary to find the best system, and the purpose of this chapter is to aid the reader in selecting the best one for his particular station.

## PROPAGATION ON 1.8 MHz

While important, propagation characteristics on 1.8 MHz are secondary to system losses since, as pointed out previously, the latter may offset any attempt to optimize for the angle of radiation. Generally speaking, the 1.8-MHz band has similar properties to those of the broadcast band (550 to 1600 kHz) but with greater significance of the sky wave. In this respect, it is not unlike the higher amateur frequencies such as 3.5 MHz, and most nighttime contacts over distances of a few hundred miles on 160 m will be by sky-wave propagation. During the daytime, absorption of the sky wave in the *D* region is almost complete but reliable communication is still possible by means of the ground wave.

With respect to sky-wave transmission, 160-meter waves entering the ionosphere, even vertically, are reflected back to earth, so that there is no such phenomenon as skip distance on these frequencies. However, as at higher frequencies, it is

still true that to cover the greatest possible distance, the waves must enter the ionosphere at low angles.

### Polarization

It was mentioned in Chapter One that a ground wave must be vertically polarized, so that the radiation from an antenna which is to produce a good ground wave likewise must be vertically polarized. This dictates the use of an antenna system of which the radiating part is mostly vertical. Horizontal polarization will produce practically no ground wave, and it is to be expected that such radiation will be ineffective for daytime communication. This is because absorption in the ionosphere in the daytime is so high at these frequencies that the reflected wave is too weak to be useful. At night a horizontal antenna will give better results than it will during the day. Ionospheric conditions permit the reflected wave to return to earth with less attenuation.

Some confusion over the term **ground wave** exists, since there are a number of propagation modes that go by this name. Here, only the type that travels over and near a conducting surface will be considered. If the surface is flat and has a very high conductivity, the attenuation of the wave follows a simple inverse-distance law. That is, every time the distance is doubled, the field strength drops by 6 dB. This law also holds for spherical surfaces for some distance, and then the field strength drops quite rapidly. For the earth, the break point is approximately 100 miles (160 km).

The conductivity of the surface is an important factor in ground-wave propagation. For example, sea water can almost be considered a perfect conductor for this purpose, at frequencies well up into the hf range. However, there may be as much as an additional 20 dB of attenuation for a 1- to 10-mile path over poor-conducting earth, compared to an equivalent path over the sea. The conductivity of sea water is roughly 400 times as great as good-conducting land (agricultural regions) and 4000 times better than poor land (cities and industrial areas).

After sundown, the propagation depends upon both the ground wave and sky wave. At the limit of the ground-wave region, the two may have equal field strengths and may either aid or cancel each other. The result is severe and rapid fading in this zone. While of less importance in amateur applica-

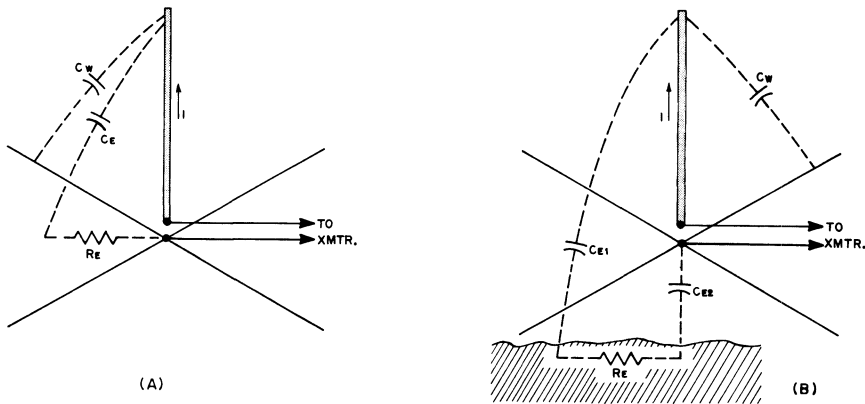

Fig. 7-1 — Drawing showing how earth currents affect the losses in a shortened-vertical antenna system. In A, the current through the combination of  $C_e$  and  $R_e$  may be appreciable if  $C_e$  is much greater than  $C_w$ , the capacitance of the vertical to the ground wires. This ratio can be improved (up to a point) by using more radials. By raising the entire antenna system off the ground,  $C_e$  (which consists of the series combination of  $C_{e1}$  and  $C_{e2}$ ) is decreased while  $C_w$  stays the same. The radial system shown at B is sometimes called a counterpoise.

tions, this effect limits the useful nighttime range of broadcast stations. Antenna designs have been developed over the years which minimize sky-wave radiation and maximize the ground wave. For broadcast work, a vertical antenna of 0.528-wavelength height is optimum over a good ground system. However, caution should be exercised in applying this philosophy to amateur installations since effective antenna systems, even for DX work, are possible with relatively high angles of radiation.

## REDUCING LOSSES IN THE ANTENNA SYSTEM

As the length of an antenna becomes small compared with the wavelength being used, the radiation resistance,  $R_a$ , drops to a very low value, as discussed in Chapter Two. The various losses can be represented by a resistance,  $R_L$ , in series with  $R_a$ .  $R_L$  may be larger than  $R_a$  in practical cases. Therefore, in an antenna system with high losses, most of the applied power is dissipated in the loss resistance and very little is radiated in  $R_a$ . Since  $R_a$  is mostly dependent upon antenna construction, efforts to reduce the loss resistance will normally not affect the radiation resistance. Efficiency can be improved significantly by keeping the loss resistance as low as possible.

The simplest losses to reduce are the conductor losses. Since electrically short antennas, such as dipoles and end-fed wires, exhibit a large series capacitive reactance, a loading coil is commonly used to tune out the reactance. If not part of the radiating system, the coil should have as high a  $Q$  as possible. Incorporating the loading coil into the radiating system not only simplifies loading-coil construction, but may actually increase the efficiency by redistributing the current in the antenna. Such loading coils are designed for low loss, rather than high  $Q$ . The reason for this is the fact that one

of the parameters that results in low coil  $Q$  is radiation. But the latter is exactly the desired result in an antenna system. The radiation from a coil increases as its length-to-diameter ratio increases. In some instances, the entire antenna may consist of a single coil. A helically wound vertical is an example of this type. In any of the loading coils that are part of the radiating system, the conductor diameter should be as large as possible, and very close spacing between turns should be avoided.

The effect of the earth on antenna loss can best be seen by examination of Fig. 7-1A. If a vertical radiator that is short compared with a wavelength is placed over a ground plane, the antenna current will consist of two components. Part of the current flows through  $C_w$ , which is the capacitance of the vertical to the radial wires, and part flows through  $C_e$ , the capacitance of the vertical to the earth. For a small number of radials,  $C_e$  will be much greater than  $C_w$ , and most of the current will flow through the circuit consisting of  $C_e$  and  $R_e$  (the earth resistance). Power will be dissipated in  $R_e$  which will not contribute to the radiation. The solution to the problem is to increase the number of radials. This will increase  $C_w$ , but, of more importance, will reduce  $R_e$  by providing more return paths. Theory and experiments have shown that the ideal radial system with a 0.528- $\lambda$  vertical consists of approximately 120 radials, each a half-wave long. If fewer radials are used (12), little is to be gained by running them out so far. The converse is also true. If space restricts the length of the radials, increasing the number much over 12 will have little effect for an antenna of this height. Since the current is greatest near the base of the antenna, a ground screen will also help if only a few radials are used.

Another method to reduce the ground currents is shown in Fig. 7-1B. By raising the antenna and ground plane off the earth,  $C_w$  stays the same in value but  $C_e$  is considerably reduced (such a system is sometimes called a counterpoise). This

decreased influence of the earth is also the reason why as few as three radials are sufficient for hf and vhf ground-plane antennas that are several feet above the earth.

The simple lumped antenna-capacitance analysis is a good approximation to actual operation if the vertical is electrically short, but analysis becomes more complicated for greater antenna lengths. For instance, the maximum ground loss for the 0.528-wave broadcast vertical mentioned earlier occurs at a point 0.35 wavelength away from the base.

Location of the antenna is perhaps more critical with regard to receiving applications than transmitting ones. Sources of strong local noise, such as TV sets and power lines, can cause considerable difficulty on 1.8 MHz. However, the proximity of rf-absorbing objects such as steel buildings may cut down on transmitting efficiency also. Since most installations are tailored to the space available, little can be done about the problem except to see that the other losses are kept to a minimum.

**ANTENNA TYPES**

A popular misconception is that antennas for 160 meters have to be much larger, higher, and more elaborate than those for the higher bands. When one considers that even the gigantic antennas used for vlf work have radiating efficiencies of approximately one percent, it is not surprising that many contacts on 160 meters can be made with little more than a piece of wire a few feet off the ground, or even from mobile installations. While it is true that a larger and more sophisticated system may perform better than a smaller one, the point here is that space restrictions should not discourage the use of the band.

**Verticals**

One of the most useful antennas for 160 meters is a vertical radiator over a ground plane. A typical installation is shown in Fig. 7-2. Some form of loading should be used since economics would not justify a full-sized quarter-wave vertical. One of the disadvantages of the vertical is the necessity of a good ground system. Some improvement has been noted by using a combination of radials and ground rods where full-length radials were impractical. The exact configuration will vary from one installation to another, and the optimum placement of the ground rods will have to be determined by experimentation.

For verticals less than an electrical quarter wave in height, the input reactance without loading will be capacitive. A simple series loading coil should be used to tune this reactance out and the coil may be the only matching network necessary.

Normally, matching to the feed line or transmitter can be accomplished with simple networks or a Transmatch. However, a rather unique method is used with certain vlf antennas which also improves the radiating efficiency as well. The technique is called multiple tuning, and is illustrated in Fig. 7-3A. A series of verticals is fed through a common flat-top structure with one of

the "downloads" also acting as a feed point. If the verticals are closely spaced (in comparison with a wavelength), the entire system can be considered to be one vertical with  $N$  times the current of one of the downloads taken alone. The result is that the radiation resistance is  $N^2 \times R_a$ , where  $R_a$  is the radiation resistance of a single vertical. This is the same principle as acquiring an impedance step-up in a multiconductor folded dipole. If the ground losses are also considered, the effective loss resistance ( $R_g$ ) would also be transformed by the same amount. However, since the current distribution in the ground is usually improved by using this method, the ratio of  $R_a/R_L$  is also improved. The disadvantages of the system are increased complexity and difficulty of adjustment. While little if any use of this principle has been applied to amateur systems for 1.8 MHz, it offers some interesting possibilities where a good ground system is impractical. The construction approach shown at B of Fig. 7-3 may be used for the erection of an experimental antenna of this type.

**Horizontal Antennas**

In cases where a good ground system is not practical and when most of the operation will rely on sky-wave propagation, horizontal antennas can be used (see Fig. 7-4). The relative simplicity of

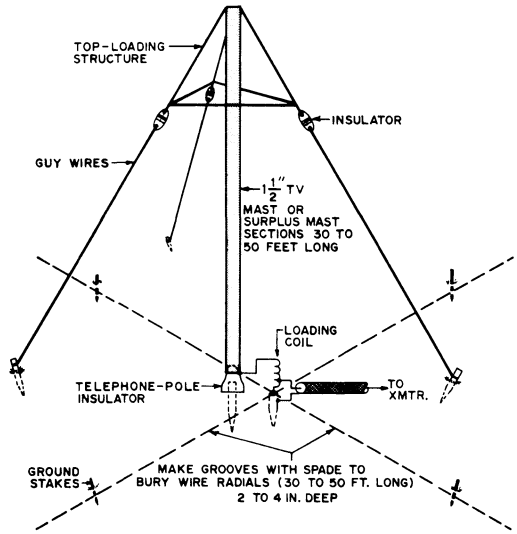

Fig. 7-2 — Physical layout of a typical vertical antenna suitable for 1.8-MHz operation. Without the top-loading structure or capacitive hat, the radiation resistance would be approximately 1 ohm for a 30-foot vertical, and 3.3 ohms for a 50-foot height. The loading inductance for the 30-foot vertical is approximately 400  $\mu$ H. Once the antenna is approximately tuned to resonance with the base loading coil, a suitable tap near the low end of the coil can be found which will give the best match for the transmitter. The radiation resistance can be increased by the use of a top-loading structure consisting of the guy wires (broken up near the top by insulators) which are connected by a horizontal wire, as shown. The radial system consists of wires buried a few inches underground.

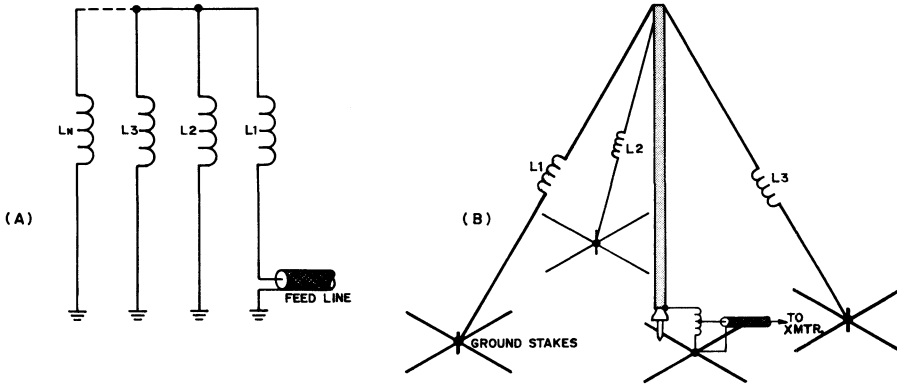

Fig. 7-3 — Possible configurations for a multiple-tuned vertical antenna for 1.8 MHz. Used extensively in vlf systems, little experimentation has been performed with it by amateurs. The principle is similar to that of the folded dipole where an impedance transformation occurs from a lower to higher value simplifying matching. The ratio is equal to  $N^2$  where  $N$  is the number of elements. In the system shown at B, the step-up ratio would be 16, since the total number of elements is four. The exact values of the loading inductors should be found experimentally, being such that the current in each leg is the same.

construction of an end-fed wire antenna makes it an attractive one for portable operation or where supporting structures are without much height.

An is the case with electrically short verticals, the input impedance of horizontal end-fed antennas less than a quarter wave in length can be considered to be a resistance in series with a capacitive reactance. Matching networks for the end-fed wire are identical to those used for verticals.

Balanced center-fed antennas are also useful, even though they may be electrically short for 160 meters and at heights typical of those used at the higher bands. For example, an 80-meter doublet fed with open-wire line may also be used on 160 meters with the appropriate matching network at the transmitter. Care should be taken to preserve the balanced configuration of the doublet in matching to this type. If one side of the feed line is

connected to ground, part of the return circuit may be through the power line. This increases the chances of interference from appliances such as TV sets and fluorescent lamps on the same circuit. Also, since there are usually connections on the power service that are not soldered, rectification may take place. The result is mixing of local broadcast stations with products on 160 meters. Filtering will not eliminate the problem because the products are in the same band with the desired signals. Problems of this type are usually less severe as the electrical length of the doublet approaches a half wave.

### Combinations of Vertical and Horizontal Antennas

The L and T antennas are the most common examples where combinations of horizontal and vertical radiators can be used to advantage. Various types are shown in Fig. 7-5. Here, the philosophy is usually to run the vertical portion up as high as possible with the horizontal part merely acting as a top-loading structure. Such a system can be considered to be equivalent to a vertical, and performance should be improved by the use of a ground system. Running the horizontal portion out to great distances may or may not improve the performance, unless the height is also increased.

A dipole fed with coaxial cable for a higher frequency band can be used as a T antenna by tying the feed-line conductors together at the transmitter. This will also work with dipoles fed with open-wire line; however, they may work just as well (or better) by using them in the most conventional manner discussed earlier. The inverted-V antenna has also given good results on 160 meters. While the center of the antenna should be as high as possible, the total angle of the V should not be less than 90 degrees at the apex. This will be determined by the height of the apex and how high the ends of the antenna are located above the ground. For angles less than 90 degrees, the

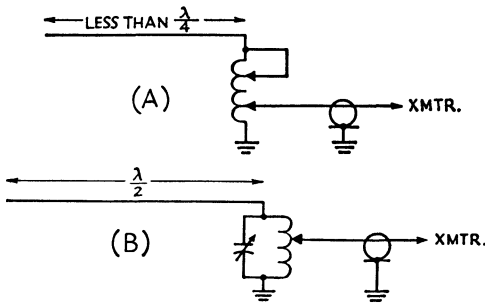

Fig. 7-4 — Two matching networks suitable for use with random-length horizontal (or vertical) wire antennas. If the electrical length is less than  $1/4$  wave, the input impedance will be equivalent to a resistance in series with a capacitive reactance and the circuit at A should be used. For lengths in the vicinity of  $1/2$  wave, the input impedance will be fairly high and may have reactances which are either inductive or capacitive. For this case, the parallel-tuned circuit in B should be used.



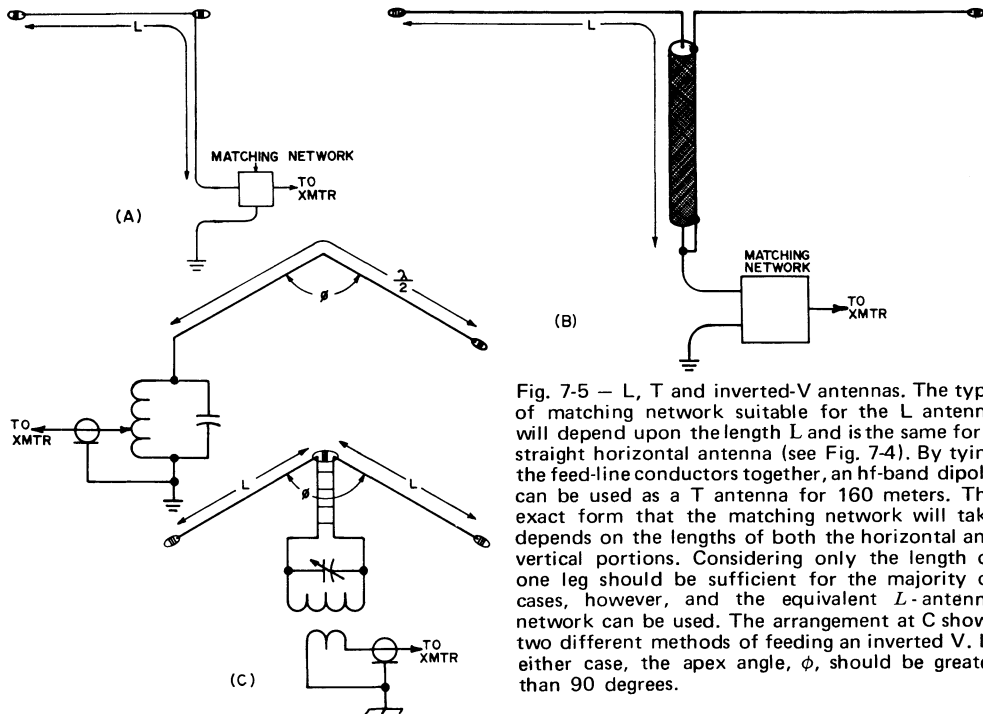

Fig. 7-5 — L, T and inverted-V antennas. The type of matching network suitable for the L antenna will depend upon the length  $L$  and is the same for a straight horizontal antenna (see Fig. 7-4). By tying the feed-line conductors together, an hf-band dipole can be used as a T antenna for 160 meters. The exact form that the matching network will take depends on the lengths of both the horizontal and vertical portions. Considering only the length of one leg should be sufficient for the majority of cases, however, and the equivalent  $L$ -antenna network can be used. The arrangement at C shows two different methods of feeding an inverted V. In either case, the apex angle,  $\phi$ , should be greater than 90 degrees.

radiation efficiency drops very rapidly. The drawings in Fig. 7-4 show some of the configurations of the various antenna types discussed.

### A RECEIVING LOOP FOR 160 METERS

Small shielded loop antennas can be used to improve reception under certain conditions, especially at the lower amateur frequencies. The foregoing is particularly true when high levels of man-made noise are prevalent, when the second-harmonic energy from a nearby broadcast station falls in the 160-meter band, or when interference exists from some other amateur station in the immediate area. A properly constructed and tuned small loop will exhibit approximately 30 dB of front-to-side response, the maximum response being at right angles to the plane of the loop. Therefore, noise and interference can be reduced significantly or completely nulled out, by rotating the loop so that it is sideways to the interference-causing source. Generally speaking, small shielded loops are far less responsive to man-made noise than are the larger antennas used for transmitting and receiving. But, a trade-off in performance must be accepted when using the loop, for the strength of received signals will be 10 or 15 dB less than when using a full-size resonant antenna. This condition is not a handicap on 160 or 80 meters, provided the station receiver has normal sensitivity and overall gain. Because a front-to-side ratio of 30 dB may be expected, a shielded loop can be used to eliminate a variety of receiving problems if made rotatable, as shown in Fig. 7-6.

In order to obtain the sharp bidirectional pattern of a small loop, the overall length of the conductor must not exceed .08 wavelength. The loop of Fig. 7-7 has a conductor length of 20 feet. At 1.810 MHz, 20 feet is .036 wavelength. With this style of loop, .036 wavelength is the maximum practical dimension if one is to tune the element to resonance. This limitation results from the distributed capacitance between the shield and inner conductor of the loop. RG-59/U was used for the loop element in this example. The capacitance per foot for this cable is 21 pF, resulting in a total distributed capacitance of 420 pF. An additional 100 pF was needed to resonate the loop at 1.810 MHz. Therefore, the approximate inductance of the loop is 15  $\mu$ H. The effect of the capacitance becomes less pronounced at the higher end of the hf spectrum, provided the same percentage of a wavelength is used in computing the conductor length. The ratio between the distributed capacitance and the lumped capacitance used at the feed point becomes greater at resonance. These facts should be contemplated when scaling the loop to those bands above 160 meters.

The radiation resistance of small loops is extremely low, thereby rendering them quite inefficient for transmitting applications. However, they can be used for that purpose if one is willing to accept a sacrifice in signal level, and if the impedance of the system is matched satisfactorily. A discussion of this subject appeared in *QST* for March, 1968 (McCoy, "The Army Loop in Ham Communication").

There will not be a major difference in the construction requirements of the loop if coaxial cables other than RG-58/U are used. The line

impedance is not significant with respect to the loop element. However, various types of coaxial line exhibit different amounts of capacitance per foot, thereby requiring more or less capacitance across the feed point to establish resonance.

Shielded loops are not affected noticeably by nearby objects, and therefore they can be installed indoors or out after being tuned to resonance. Moving them from one place to another does not significantly affect the tuning.

In the model shown here it can be seen that a supporting structure was fashioned from bamboo poles. The X frame is held together at the center by means of two U bolts. The loop element is taped to the cross arms to form a square. It is likely that one could use metal cross arms without degrading the antenna performance. Alternatively, wood can be used for the supporting frame.

A Minibox was used at the feed point of the loop to contain the resonating variable capacitor. In this model a 50- to 400-pF compression trimmer is used to establish resonance. It is necessary to weatherproof the box for outdoor installations.

The shield braid of the loop coax is removed for a length of one inch directly opposite the feed point. The exposed areas should be treated with a sealing compound once this is done.

In operation this receiving loop has been very effective in nulling out second-harmonic energy from local broadcast stations. During DX and contest operation on 160 meters it helped prevent receiver overloading from nearby 160-meter stations that share the band. The marked reduction in response to noise has made the loop a valuable station accessory when receiving weak signals. It is not used all of the time, but is available when needed by connecting it to the receiver through an

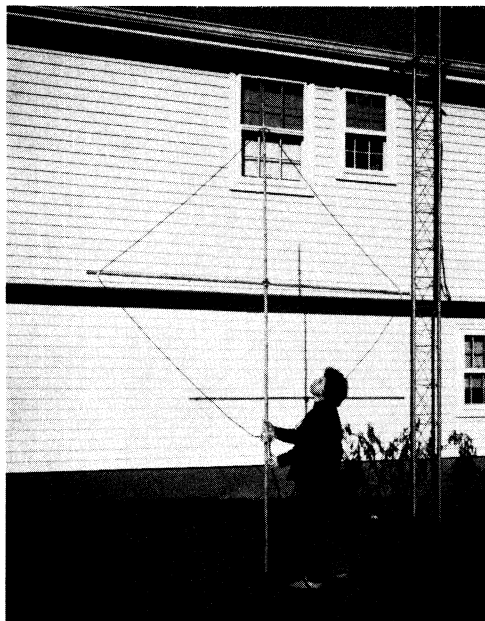

Fig. 7-6 — The 160-meter shielded loop. Bamboo cross arms are used to support the antenna.

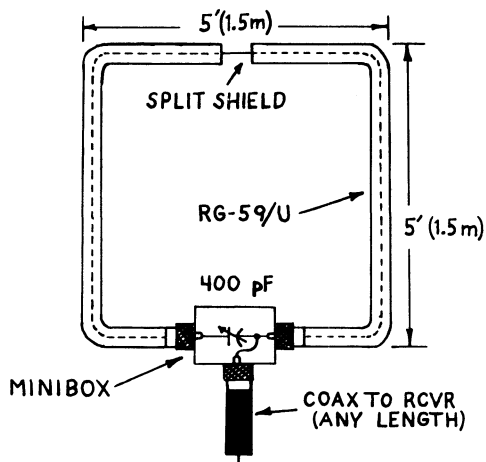

Fig. 7-7 — Schematic diagram of the loop antenna. The dimensions are not critical provided overall length of the loop element does not exceed approximately .04 wavelength. Small loops which are one half or less the size of this one will prove useful where limited space is a consideration.

antenna-selector switch. Reception of European DX stations with the loop has been possible from New England at times when other antennas were totally ineffective because of noise.

It was also discovered that the effects of approaching storms (with attendant atmospheric noise) could be nullified considerably by rotating the loop away from the storm front. It should be said that the loop does not exhibit meaningful directivity when receiving sky-wave signals. The directivity characteristics relate primarily to ground-wave signals. This characteristic is discussed further in Chapter Sixteen. This is a bonus feature in disguise, for when nulling out local noise or interference, one is still able to copy sky-wave signals from all compass points!

For receiving applications it is not necessary to match the feed line to the loop, though doing so may enhance the performance somewhat. If no attempt is made to secure an SWR of 1, the builder can use 50- or 75-ohm coax for a feeder, and no difference in performance will be observed. The  $Q$  of this loop is sufficiently low to allow the operator to peak it for resonance at 1900 kHz and use it across the entire 160-meter band. The degradation in performance at 1800 and 2000 kHz will be so slight that it will be difficult to discern.

#### Bibliography

Source material and more extended discussion of topics covered in this chapter can be found in the references given below.

- Brown, "The Phase and Magnitude of Earth Currents Near Radio Transmitting Antennas," *Proceedings of the I.R.E.* Feb., 1935.
- Brown, Lewis, and Epstein, "Ground Systems as a Factor in Antenna Efficiency," *Proceedings of the I.R.E.* June, 1937.
- "Some Notes on Ground Systems for 160 Meters," *QST*, April, 1965.

# Antennas for 3.5 and 7 MHz

Multiband antennas constructed as described in Chapter Six obviously will be useful on 3.5 and 7 MHz, and, in fact, the end-fed and center-fed antennas shown in Chapter Six are quite widely used for 3.5- and 7-MHz operation. The center-fed system is better because it is inherently balanced on both bands and there is less chance for feeder radiation and rf feedback troubles, but either system will give a good account of itself. On these frequencies the height of the antenna is not too important, and anything over 35 feet will work well for average operation. This chapter is concerned principally with antennas designed for use on one band only.

## HALF-WAVELENGTH ANTENNAS

An untuned or "flat" feed line is a logical choice on any band, because the losses are low, but it generally limits the use of the antenna to one band. Where only single-band operation is wanted,

the half-wave antenna fed with untuned line is one of the most popular systems on the 3.5- and 7-MHz bands. If the antenna is a single-wire affair, its impedance is in the vicinity of 60 ohms. The most logical way to feed the antenna is with 72-ohm Twin-Lead or 50- or 72-ohm coaxial line. The heavy-duty Twin-Lead and the coaxial line present support problems, but these can be overcome by using a small auxiliary pole to take the weight of the line. The line should come away from the antenna at right angles, and it can be of any length.

A "folded dipole" shows an impedance of 300 ohms, and so it can be fed directly with any length of 300-ohm TV line. The line should come away from the antenna at as close to a right angle as possible. The folded dipole can be made of ordinary wire spaced by light-weight wooden or plastic spacers, 4 or 6 inches long, or a piece of 300-ohm TV line can be used for the folded dipole.

A folded dipole can be fed with a 600-ohm open-wire line with only a 2-to-1 SWR, but a

Fig. 8-1 — Half-wavelength antennas for single-band operation. The multiwire types shown in B, C and D offer a better match to the feeder over a somewhat wider range of frequencies but otherwise the performances are identical. The feeder should run away from the antenna at a right angle for as great a distance as possible. In the coupling circuits shown, tuned circuits should resonate to the operating frequency. In the series-tuned circuits of A, B, and C, high  $L$  and low  $C$  are recommended, and in D the inductance and capacitance should be similar to the output-amplifier tank, with the feeders tapped across at least  $1/2$  the coil. The tapped-coil matching circuit or the Transmatch, both shown in Chapter Six, can be substituted in each case.

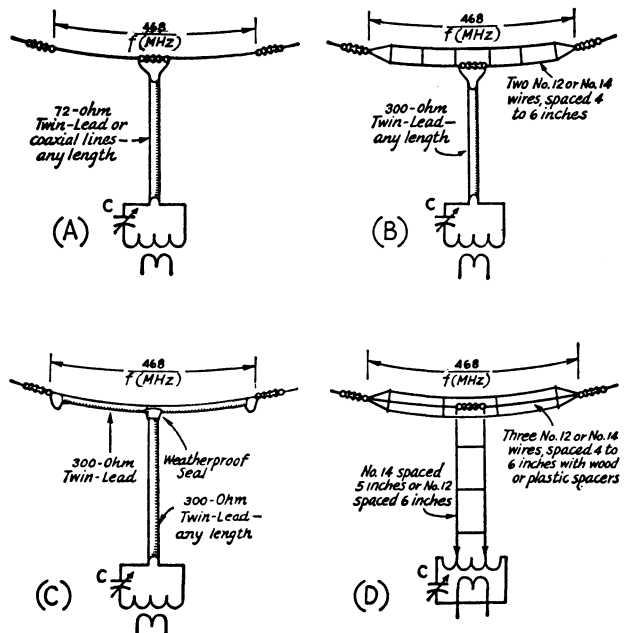

nearly perfect match can be obtained with 600-ohm open line and a three-wire dipole.

The three types of half-wavelength antennas just discussed are shown in Fig. 8-1. One advantage of the two- and three-wire antennas over the single wire is that they offer a better match over a band. This is particularly important if full coverage of the 3.5-MHz band is contemplated.

While there are many other methods of matching lines to half-wavelength antennas, the three mentioned are the most practical ones. It is possible, for example, to use a quarter-wavelength transformer of 150-ohm Twin-Lead to match a single-wire half-wavelength antenna to 300-ohm feed line. But if 300-ohm feed line is to be used, a folded dipole offers an excellent match without the necessity for a matching section.

The formula shown above each antenna in Fig. 8-1 can be used to compute the length at any frequency, or the length can be obtained directly from the charts in Fig. 8-2.

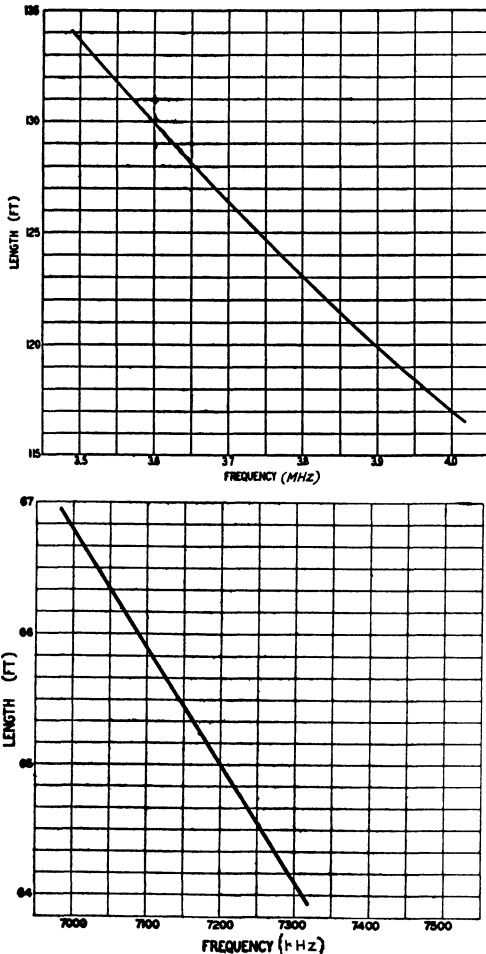

Fig. 8-2 — The above charts can be used to determine the length of a half-wave antenna of wire.

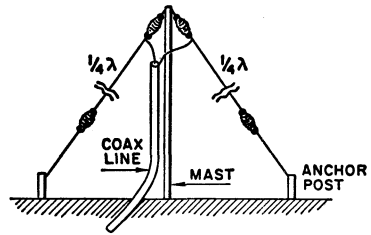

Fig. 8-3 — The inverted-V dipole. The length and apex angle should be adjusted as described in the text.

### Inverted-V Dipole

The halves of a dipole may be sloped to form an inverted V, as shown in Fig. 8-3. This has the advantages of requiring only a single high support and less horizontal space. K7GCO and others have also reported that the dipole in this form is more effective than a horizontal antenna, especially for frequencies of 7 MHz and lower.

Sloping of the wires results in a decrease in the resonant frequency and a decrease in feed-point impedance and bandwidth as the angle between the two wires is decreased. Thus, for the same frequency, the length of the dipole must be decreased somewhat. The angle at the apex is not critical, although it should probably be made no smaller than 90 degrees. Because of the lower impedance, a 50-ohm line should be used, and the usual procedure is to adjust the angle for lowest SWR while keeping the dipole resonant by adjustment of length. Bandwidth may be increased by using multiconductor elements, such as the cage configuration.

### VERTICAL ANTENNAS

For 3.5-MHz work, the vertical can be a quarter wavelength long (if one can get the height), or it can be something less than this and "top-loaded." The bottom of the antenna has only to clear the ground by inches. Probably the cheapest construction of a quarter-wavelength vertical involves running copper or aluminum wire alongside a wooden mast. A metal tower can also be used as a radiator. If the tower is grounded, the antenna can be "shunt-fed," as shown in B of Fig. 8-4. The "gamma" matching system described in Chapter Three may also be used. A good ground system is helpful in feeding a quarter-wavelength vertical antenna, and the ground can be either a convenient water-pipe system or a number of radial wires extending out from the base of the antenna for about a quarter wavelength.

### The Ground Plane

The size of a ground-plane antenna makes it a little impractical for 3.5-MHz work, but one can be used at 7 MHz to good advantage, particularly for DX work. This type of antenna can be placed higher above ground than an ordinary vertical

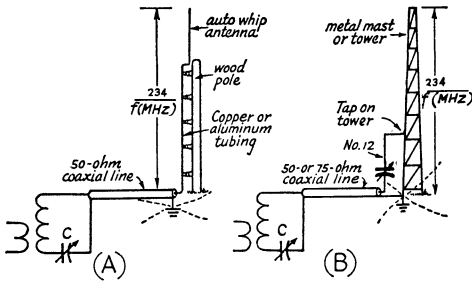

Fig. 8-4 — Vertical antennas are effective for 3.5- or 7-MHz work. The quarter-wavelength antenna shown at A is fed directly with 50-ohm coaxial line, and the resulting standing-wave ratio is usually less than 1.5 to 1, depending on the ground resistance. If a grounded antenna is used as at B, the antenna can be shunt-fed with either 50- or 75-ohm coaxial line. The tap for best match and the value of C will have to be found by experiment; the line running up the side of the antenna should be spaced from 6 to 12 inches from the antenna. The length (height) of the antenna can be computed from the formula, or it can be obtained from Fig. 8-2 by using just one half the length indicated in the chart. For example, at 3.6 MHz, the length is  $130'/2 = 65'$ .

without decreasing the low-angle radiation. The vertical member can be a length of self-supporting tubing at the top of a short mast, and the radials can be lengths of wire used also to support the mast. The radials do not have to be exactly horizontal, as shown in Fig. 8-5.

The ground-plane antenna can be fed directly with 50-ohm cable, although the resulting SWR on the line will not be as low as it will if the antenna is designed with a stub matching section, as described in Chapter Three. However, the additional loss caused by an SWR as high as 2 to 1 will be inappreciable even in cable runs of several hundred feet when the frequency is as low as 7 MHz.

**PHASED VERTICALS**

Two or more vertical antennas spaced a half wavelength apart can be operated as a single antenna system to obtain additional gain and a

directional pattern. The following design for 40-meter phased verticals is contributed by Gary Elliott, KH6HCM/W7UXP. An 80-meter version can be constructed by proper scaling. There are practical ways that verticals for 40 meters can be combined, end-fire and broadside. In the broadside configuration, the two verticals are fed in phase, producing a figure-eight pattern that is broadside to the plane of the verticals. In an end-fire

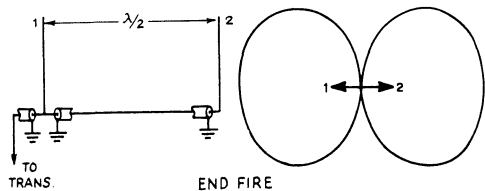

Fig. 8-6 — Pattern for two  $1/4\lambda$  verticals spaced one-half wavelength apart fed 180 degrees out of phase. The arrow represents the axis of the elements.

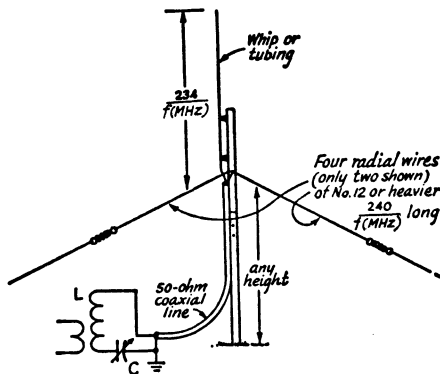

Fig. 8-5 — A ground-plane antenna is effective for DX work on 7 MHz. Although its base can be any height above ground, losses in the ground underneath will be reduced by keeping the bottom of the antenna and the ground plane as high above ground as possible. Feeding the antenna directly with 50-ohm coaxial cable will result in a low standing-wave ratio. The length of the vertical radiator can be computed from the formula, or it can be obtained from Fig. 8-2 by using just one half the length indicated in the chart. The radial wires are 2.5% longer. For example, at 7.1 MHz, the radiator is  $65' 11''/2 \approx 33'$ ; the radials are  $1.025 \times 33 = 33' 10''$ .

arrangement, the two verticals are fed out of phase, and a figure-eight pattern is obtained that is in line with the two antennas, Fig. 8-6. However, an end-fire pair of verticals can be fed 90 degrees out of phase and spaced a quarter wavelength apart, and the resulting pattern will be unidirectional. The direction of maximum radiation is in line with the two verticals, and in the direction of the vertical receiving the lagging excitation; see Fig. 8-7.

**Construction**

Physically, each vertical is constructed of telescoping aluminum tubing that starts off at 1-1/2-inch dia and tapers down to 1/4-inch dia at the top. The length of each vertical is 32 feet. Each vertical is supported on two standoff insulators set on a 2 by 4, 6 feet long and strapped to a fence. An alternative method of mounting would be a 2 by 4 about 8 feet long and set about 2 feet in the ground.

Originally each vertical element was 32 feet, 6 inches long,  $234/f$  (MHz). After one vertical was mounted on the 2 x 4 it was raised into position and the resonant frequency was checked with an antenna noise bridge. It was found that the vertical

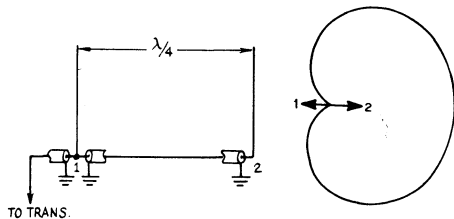

Fig. 8-7 — Pattern for two  $1/4\text{-}\lambda$  verticals spaced  $1/4$  wavelength apart and fed  $90$  degrees out of phase. The arrow represents the axis of the elements, with the element on the right being the one of lagging phase.

resonated too low in frequency, about  $6.9$  MHz. This was to be expected as the fundamental equation for the quarter-wave vertical,  $234/f$ , is only reasonably correct for very small-diameter tubing or antenna wire. When larger diameter tubing ( $1\text{-}1/4$  inch and larger) is used, the physical length will be shorter than this, as described in Chapter Two. Using the antenna noise bridge, an inch at a time was cut off the top until the resonant frequency was  $7100$  kHz. This resulted in  $6$  inches being cut off, thus making the vertical exactly  $32$  feet long.

The ground system is very important in the operation of a vertical. The two usual methods of obtaining a ground system with verticals are shown in Fig. 8-8.

### Feed System

In order to obtain the unidirectional pattern shown in Fig. 8-7, the two verticals must be separated by a quarter wavelength, and one vertical must be fed  $90$  degrees behind the other. Two suggested feed methods are shown in Fig. 8-9. An electrical section of line cannot be used by itself to connect the two verticals together to obtain the  $90$ -degree lag because of the velocity factor of RG-8/U. The length of an electrical wavelength of transmission line is based on the calculation:

$$\frac{246 \times 0.66}{7.1 \text{ MHz}} = 22' 10''$$

(Further information concerning velocity factor and transmission lines can be found in Chapter

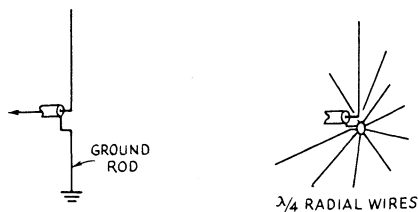

Fig. 8-8 — An  $8\text{-}$  to  $10\text{-}$ ft. ground rod may provide a satisfactory ground system in marshy or beach areas, but in most locations a system of radial wires will be necessary.

Three in the section on electrical length.) Obviously,  $22$  feet,  $10$  inches of coax cannot be used, as the verticals are spaced  $34.6$  feet apart. This is overcome and a  $90$ -degree lag is still obtained by using a  $3/4$ -wavelength section of transmission line between the two verticals, Fig. 8-9A. The SWR is less than  $1.25$  to  $1$  across the entire band, using  $52\text{-ohm}$  coax and no matching network.

### PHASED ARRAYS

Phased arrays with horizontal elements can be used to advantage at  $7$  MHz, if they can be placed at least  $40$  feet above ground. Any of the usual combinations will be effective. If a bidirectional characteristic is desired, the W8JK type of array, shown at A in Fig. 8-10, is a good one. If a unidirectional characteristic is required, two elements can be mounted about  $20$  feet apart and provision included for tuning one of the elements

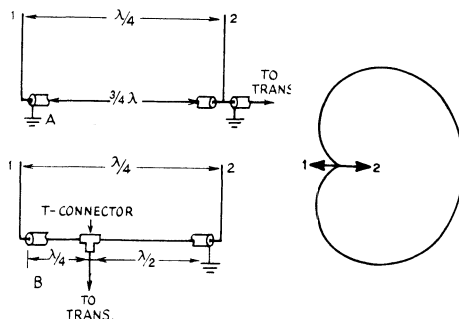

Fig. 8-9 — Two methods of feeding the phased verticals.

as either a director or reflector, as shown in Fig. 8-10B. The parasitic element is tuned at the end of its feed line with a series- or parallel-tuned circuit (whichever would normally be required to couple power into the line), and the proper tuning condition can be found by using the system for receiving and listening to distant stations along the line of maximum radiation of the antenna. Tuning the feeder to the parasitic element will peak up the signal.

### 40-METER LOOP

An effective but simple  $40\text{-meter}$  antenna that has a theoretical gain of approximately  $2$  dB over a dipole is a full-wave, closed loop. A full-wavelength closed loop need not be square. It can be trapezoidal, rectangular, circular, or some distorted configuration in between those shapes. For best results, however, the builder should attempt to make the loop as square as possible. The more rectangular the shape the greater the cancellation of energy in the system, and the less effective it will be. The effect is similar to that of a dipole, its effectiveness becoming impaired as the ends of the dipole are brought closer and closer together. The

Fig. 8-10 — Directional antennas for 7 MHz. To realize any advantage from these antennas, they should be at least 40 feet high. The system at A is bidirectional, and that at B is unidirectional in a direction depending upon the tuning conditions of the parasitic element. The length of the elements in either antenna should be exactly the same, but any length from 60 to 150 feet can be used. If the length of the antenna at A is between 60 and 80 feet, the antenna will be bidirectional along the same line on both 7 and 14 MHz. The system at B can be made to work on 7 and 14 MHz in the same way, by keeping the length between 60 and 80 feet.

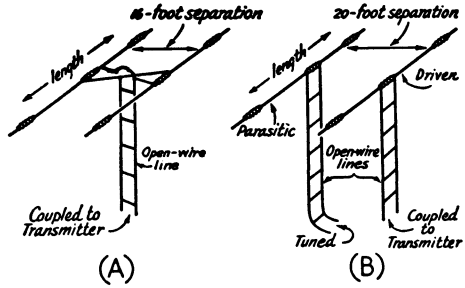

practical limit can be seen in the “inverted-V” antenna, where a 90-degree apex angle between the legs is the minimum value ordinarily used. Angles that are less than 90 degrees cause serious cancellation of the rf energy.

The loop can be fed in the center of one of the vertical sides if vertical polarization is desired. For horizontal polarization it is necessary to feed either of the horizontal sides at the center.

Optimum directivity occurs at right angles to the plane of the loop, or in more simple terms, broadside from the loop. Therefore, one should try to hang the system from available supports which will enable the antenna to radiate the maximum amount in some favored direction.

Just how the wire is erected will depend on what is available in one’s yard. Trees are always handy for supporting antennas, and in many instances the house is high enough to be included in the lineup of solid objects from which to hang a radiator.

If only one supporting structure is available it should be a simple matter to put up an A frame or pipe mast to use as a second support. (Also, tower owners see Fig. 8-11 inset.)

The overall length of the wire used in a loop is determined in feet from the formula  $1005/f$  (MHz). Hence, for operation at 7125 kHz the overall wire length will be 141 feet. The matching transformer, an electrical quarter wavelength of 75-ohm coax cable, can be computed by dividing 246 by the operating frequency in MHz, then multiplying that number by the velocity factor of the cable being used. Thus, for operation at 7125 kHz,  $246/7.125 \text{ MHz} = 34.53$  feet. If coax with solid polyethylene insulation is used a velocity factor of 0.66 must be employed. Foam-polyethylene coax has a velocity factor of 0.80. Assuming RG-59/U is used, the length of the matching transformer becomes  $34.53$  (feet)  $\times 0.66 = 22.79$  feet or 22 feet, 9-1/2 inches.

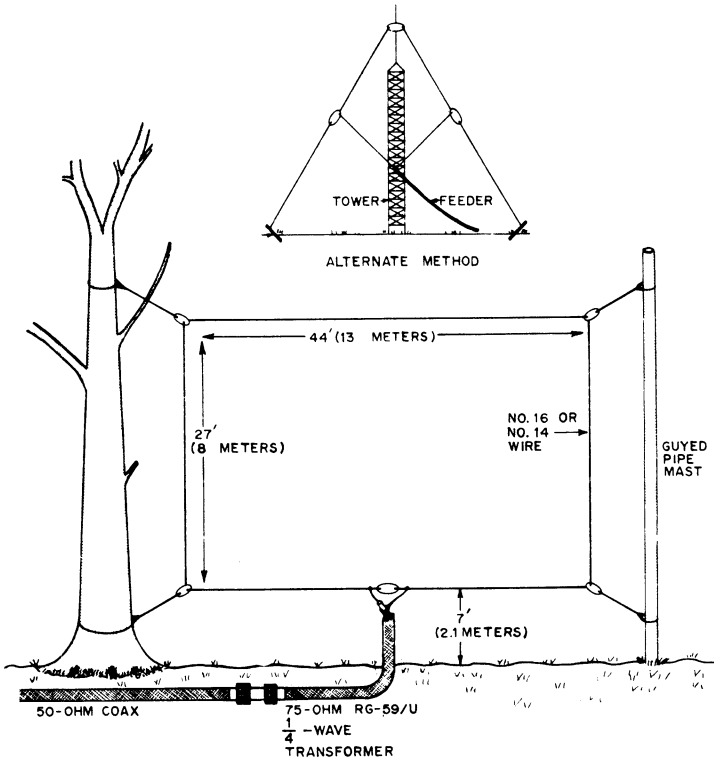
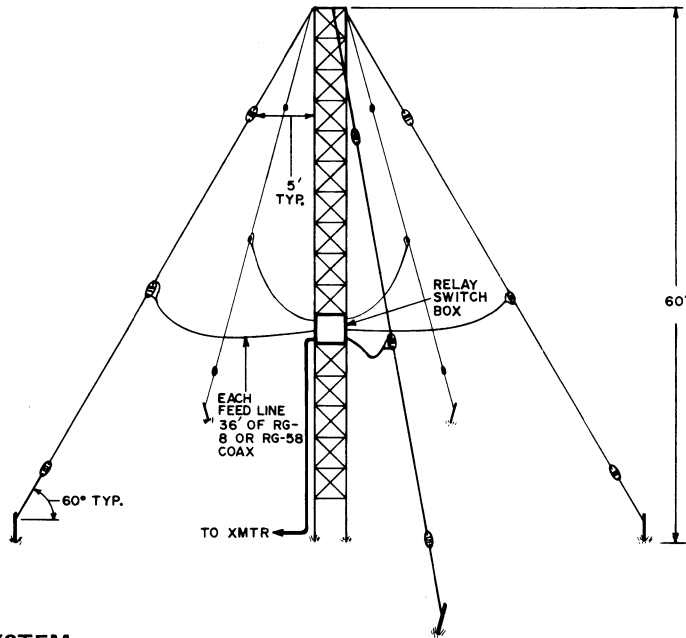

Fig. 8-11 — Details of the full-wave loop. The dimensions given are for operation at the low end of 40 meters (7050 kHz). The height above ground was 7 feet in this instance, though improved performance should result if the builder can install the loop higher above ground without sacrificing length on the vertical sides. The inset illustrates how a single supporting structure can be used to hold the loop in a diamond-shaped configuration. Feeding the diamond at the lower tip provides radiation in the horizontal plane. Feeding the system at either side will result in vertical polarization of the radiated signal.

This same loop antenna may be used on the twenty- and fifteen-meter bands, although its pattern will be somewhat different than on its fundamental frequency. Also, a slight mismatch will occur, but this can be overcome by a simple matching network. When the loop is mounted in a vertical plane, it tends to favor low-angle signals. If a high-angle system is desired, say for 80 meters, the full-wave loop can be mounted in a horizontal plane, thirty or more feet above ground. This arrangement will direct most of the energy virtually straight up, providing optimum sky-wave coverage on a short-haul basis.



#### 40-METER "SLOPER" SYSTEM

One of the more popular antennas for 3.5 and 7 MHz is the sloping dipole. David Pietraszewski, K1THQ, has made an extensive study of sloping dipoles at different heights with reflectors at the 3-GHz frequency range. From his experiments, he developed the novel 40-meter antenna system described here. With several sloping dipoles supported by a single mast and a switching network, an antenna with directional characteristics and forward gain can be simply constructed. This 40-meter system uses several "slopers" equally spaced around a common center support. Each dipole is cut to a half wavelength and fed at the center with 52-ohm coax. The length of each feed line is 36 feet. This length is just over  $3/8 \lambda$ , which provides a useful quality. All of the feed lines go to a common point on the support (tower) where the switching takes place. At 7 MHz, the 36-foot length of coax looks inductive to the antenna when the end at the switching box is open circuited. This has the effect of adding inductance at the center of the sloping dipole element, which electrically lengthens the element. The 36-foot length of feed line serves to increase the length of the element about 5%. This makes any unused element appear to be a reflector.

The array is simple and effective. By selecting one of the slopers through a relay box located at the tower, the system becomes a parasitic array which can be electrically rotated. All but one element of the array become reflectors, while one element is driven.

The basic physical layout is shown in Fig. 8-12. The height of the support point should be about 60 feet, but can be less and still give reasonable results. The upper portion of the sloper is five feet

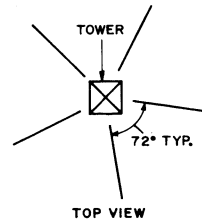

Fig. 8-12 — Five sloping dipoles suspended from one support. Directivity and forward gain can be obtained from this simple array. Top view shows how the elements should be spaced around the support.

from the tower, suspended by rope, and makes an angle of 60 degrees with the ground. In Fig. 8-13, the switch box is shown containing all the necessary relays required to select the proper feed line for the desired direction. One feed line is selected at a time and opens the feed lines of those remaining. In this way the array is electrically rotated. These relays are controlled from inside the shack with an appropriate power supply and rotary switch. For safety reasons and simplicity, 12-volt dc relays are used. The control line consists of a five conductor cable, one wire used as a common connection; the others go to the four relays. By using diodes in series with the relays and a dual-polarity power supply, the number of control wires can be reduced, as shown in Fig. 8-15B.

Measurements indicate that this sloper array provides up to 20 dB front-to-back ratio and forward gain of about 4 dB. If one direction is the only concern, the switching system can be eliminated and the reflectors should be cut 5



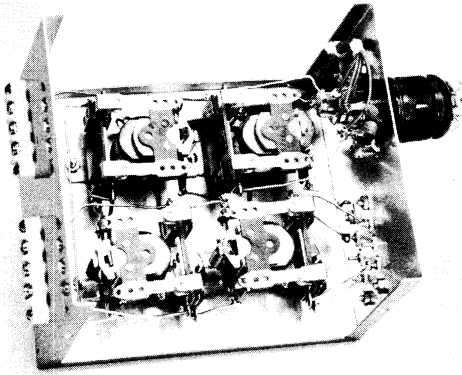

Fig. 8-13 — Inside view of relay box. Four relays provide control over five antennas. See text. The relays pictured here are Potter and Brumfield type MR11D.

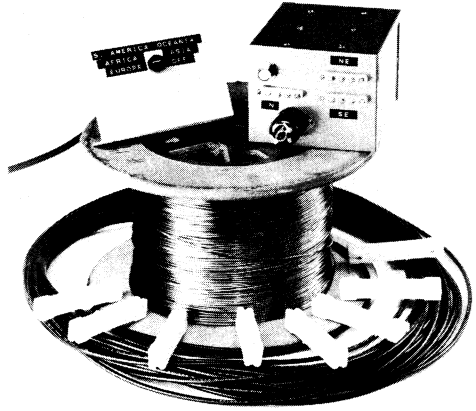

Fig. 8-14 — The basic materials required for the sloper system. Control box at left and relay box at right.

percent longer than the resonant frequency. The one feature which is worth noting is the good front-to-back ratio. By arranging the system properly, a null can be placed in an unwanted direction, thus making it an effective receiving antenna. In the tests conducted with this antenna, the number of reflectors used were as few as one and as many as five. The optimum combination appeared to occur with four reflectors and one driven element. No tests were conducted with more than five reflectors. This same array can be scaled to 80 meters for similar results. The basic

materials required for the sloper system are shown in Fig. 8-14.

**Bibliography**

- Source material and more extended discussion of topics covered in this chapter can be found in the references given below.
- Elliott, "Phased Verticals for 40," *QST*, April, 1972.
- Hubbell, "Feeding Grounded Towers as Radiators," *QST*, June, 1960.

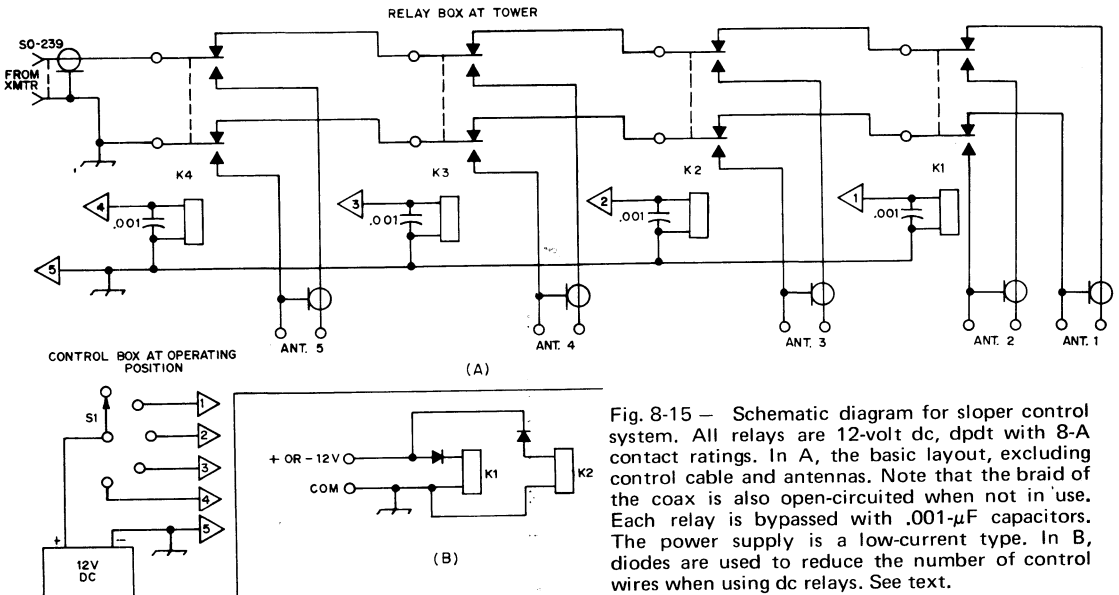

Fig. 8-15 — Schematic diagram for sloper control system. All relays are 12-volt dc, dpdt with 8-A contact ratings. In A, the basic layout, excluding control cable and antennas. Note that the braid of the coax is also open-circuited when not in use. Each relay is bypassed with .001-μF capacitors. The power supply is a low-current type. In B, diodes are used to reduce the number of control wires when using dc relays. See text.

# Antennas for 14, 21, and 28 MHz

The antenna systems discussed in Chapter Six can, of course, be used on 14, 21 and 28 MHz with good results. The half-wave antenna for 3.5 MHz, fed with tuned feeders, becomes a multiwavelength antenna at these higher frequencies, and the directional characteristics become a little more apparent than at the lower frequencies. Similarly, a 7-MHz half-wave antenna using a tuned feed line likewise can be used on the harmonically related higher frequency bands.

## Half-Wave Dipoles

The half-wave dipole fed with a matched transmission line is often used on the 14-, 21-, and 28-MHz bands. Like its low-frequency counterpart

described in Chapter Eight, it is ordinarily useful only on the band for which it is designed. Suitable lengths for wire antennas are given in Fig. 9-1, and Fig. 3-53 should be referred to if feeder resonances are to be avoided. Vertical antennas (and the ground plane in particular) can be used at these frequencies and will give good low-angle radiation. However, with a vertical receiving antenna, man-made noise pickup is likely to be greater than with a horizontal antenna.

The directional pattern of a half-wavelength horizontal antenna becomes apparent at these frequencies, and it is not unwise to provide two half-wave horizontal antennas for these bands at right angles to each other, with a suitable switching arrangement to permit using one antenna or the other, depending upon the direction of the desired signal. Better still is to use a single half-wave antenna that can be rotated at least 135°.

## A BEAM ANTENNA FOR 15 METERS

Half-wave antennas, as previously discussed in this chapter, are usually simple to construct from wire and provide reasonable performance. When

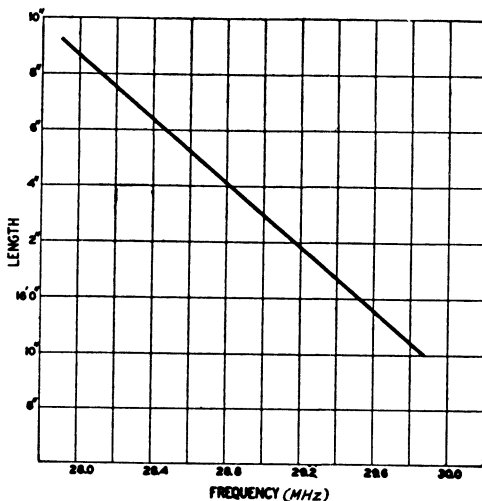
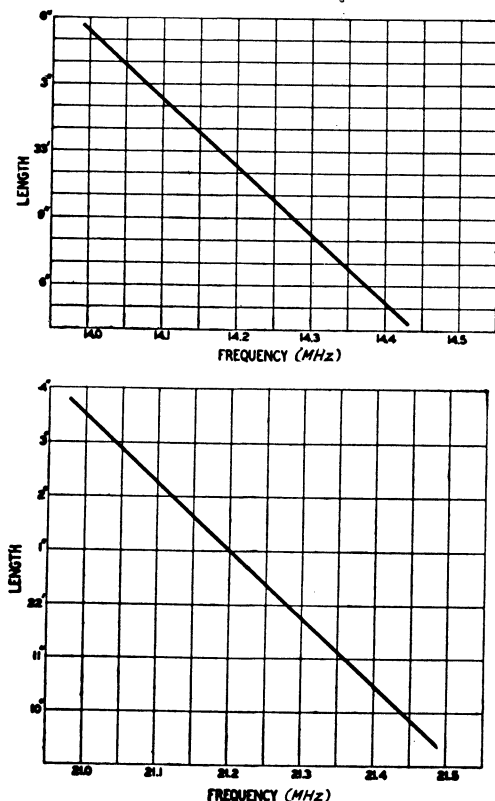

Fig. 9-1 — Charts for determining the length of a half-wave wire antenna at 14, 21 and 28 MHz, based on  $468/f$  (MHz).

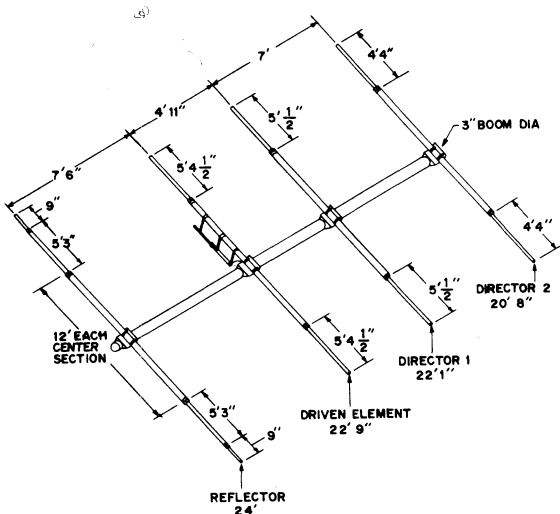

Fig. 9-2 — Overall dimensions for the 4-element 15-meter array.

the amateur is interested in constructing an array which can be rotated, aluminum tubing is used for the elements. The mechanical problems encountered are usually not much greater for several elements than with single-element rotatable antenna systems.

This four-element Yagi antenna provides appreciable power gain and exhibits significant back-

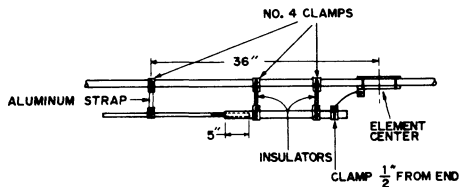

Fig. 9-3 — Gamma-matching-section dimensions for the 15-meter 4-element array (also see Fig. 9-7).

rejection characteristics. Overall dimensions are given in Fig. 9-2. Construction is straightforward using commonly available tubing material which normally is 12 feet long. The center of each element is made from a 12-foot length of 6061-T6 aluminum alloy which is 1-1/8 inches in diameter. The overall length of the element is determined by the distance the telescoping section is extended beyond the end of the center piece. Each of these telescoping sections is one inch OD and six feet long to provide the proper fit. Table I in Chapter Fourteen provides a guide for determining proper sizes for element material diameters. When telescoping sections are needed, the difference between joining pieces (in terms of diameters) should be about .009 inch. An additional section of 7/8-inch OD material is used at the tips of the reflector element to meet the dimensions specified. The two 7/8-inch pieces extend about nine inches beyond the one-inch diameter stock.

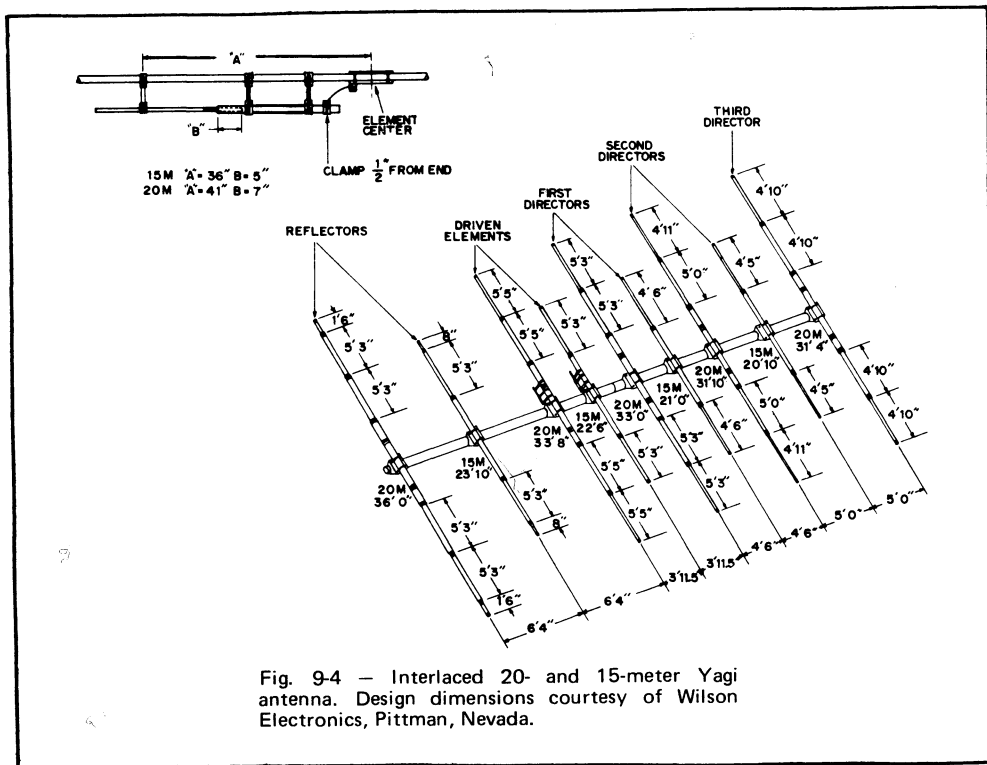

Fig. 9-4 — Interlaced 20- and 15-meter Yagi antenna. Design dimensions courtesy of Wilson Electronics, Pittman, Nevada.

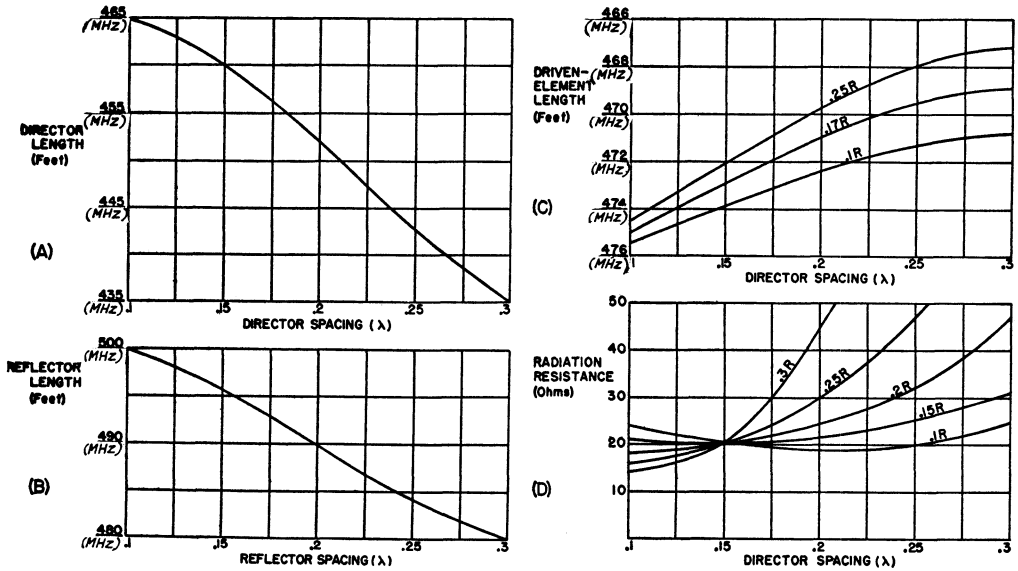

Fig. 9-5 — Element lengths for 3-element Yagis. These lengths will hold closely for tubing elements supported at or near the center. The radiation resistance (D) is useful information in planning for a matching system, but it is subject to variation with height above ground and must be considered an approximation. The driven-element length (C) may require modification for tuning out reactance if a gamma- or hairpin-match feed system is used.

A 0.2D-0.2R beam cut for 28.6 MHz would have a director length of  $452/28.6 = 15.8 = 15$  feet 10 inches, a reflector length of  $490/28.6 = 17.1 = 17$  feet 1 inch, and a driven-element length of  $470.5/28.6 = 16.45 = 16$  feet 5 inches.

Each element is held in place with two U bolts which clamp it to a six-inch long piece of aluminum stock. These pieces of angle material are then fastened to the boom with automotive muffler clamps. The size of the muffler clamp depends on the size of the boom. For this model, a two-inch diameter boom size should be satisfactory for all but the roughest climate conditions. A three-inch diameter boom does have advantages, however, as explained in Chapter Fourteen.

Matching a feed line to the driven element can be accomplished by using the dimensions given in Fig. 9-3. Final adjustment of the gamma system should be made after the antenna is mounted in place atop the mast by placing a power meter (or SWR indicator) in series with the feed line at the input connector and adjusting the capacitor along with the tap point for minimum reflected power as described in Chapter Three.

The mechanical dimensions for the Yagi described here were developed by Wilson Electronics,

Pittman, Nevada. While gain measurements are impossible without a test facility, the estimated power gain of this system is on the order of 9 dB. The front-to-back ratio is typically 20 or 25 dB.

### AN INTERLACED YAGI FOR 20 AND 15 METERS

Many times it is desirable to install more than one antenna on top of a single tower or mast. Stacking antennas, one above the other, creates a large stress on the mast and the rotor. With large arrays, it is desirable to reduce the weight and wind loading characteristics in every possible way to lower damage possibilities from ice, wind, and other undesirable weather creations. One simple solution to the problem is to mount two complete antennas on one boom.

Installing elements for two different antennas on one boom has been popular for many years.

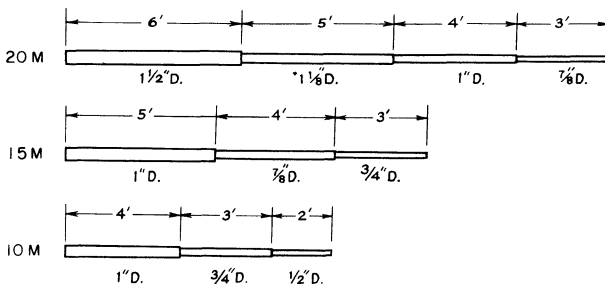

Fig. 9-6 — Suggested proportions for one side of tapered Yagi elements. The other side is identical, of course, and the center section of the element can be a single piece twice as long as the length shown here for the first (largest diameter) section. Appropriate overall element lengths may be determined from the graphs of Fig. 9-5. See Table 14-1 for aluminum tubing details.

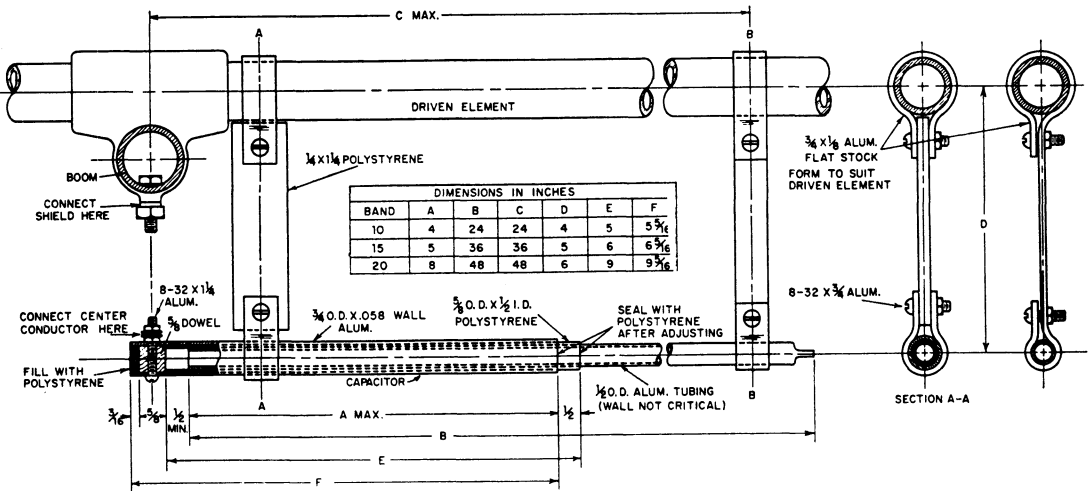

Fig. 9-7 - Constructional details of a gamma-matching section for 52-ohm coax line. The reactance-compensating capacitor is in tubular form. It is made by dividing the gamma rod or bar into two telescoping sections separated by a length of polystyrene tubing, which serves as the dielectric.

Most commercially manufactured triband antennas use this technique. The question which develops, however, is whether or not interaction between elements for different bands causes detrimental effects. It is generally accepted that interaction, if any, is very minimal between bands which are not harmonically related. The example shown here is a Wilson Electronics Model DB-54 designed to operate on both 15 and 20 meters. Two driven elements are required and each is fed independently with separate transmission lines. The boom is 40 feet long and is three inches OD. Smaller boom sizes are not recommended.

Constructional details of this system are similar to those given for the 15-meter antenna described earlier in this chapter except the element center sections for 20 meters begin with 1-1/4 inch material and telescope down in size. The 15-meter elements are identical to the ones described earlier. All of the critical dimensions are given in Fig. 9-4.

A long boom needs to have additional support given to it if appreciable sag or droop is to be avoided. The truss can be made of any suitable steel wire and should be connected to points about 10 feet in each direction from the boom-to-mast support. Turnbuckles should be used at the mast to create suitable tension for the wires. Each of the interlaced arrays can be treated as separate antennas for the purposes of tune-up. Since there is little (if any) interaction between elements, the 15-meter section could be removed from the boom if only a 20-meter monoband system is needed.

**THE THREE-ELEMENT MONOBAND YAGI**

Perhaps the most popular type of antenna used on 20, 15 and 10 meters is the three-element array. Three elements offer the best compromise between gain, size, weight, wind loading, and front-to-back ratio. Constructional techniques should be the

same as specified with the two antennas described earlier in this chapter.

Fig. 9-5 gives suitable dimensions for a three-element antenna. Hardware sizes should approximate the values given in Fig. 9-6. A gamma-matching system is easy to construct and adjust correctly. The dimensions shown in Fig. 9-7 are typical of the requirements for a working system. Should the builder desire to use a hairpin match arrangement, Chapter Three should be consulted.

**A THREE-BAND QUAD ANTENNA SYSTEM**

Quads have been popular with amateurs during the past few decades because of their light weight, relatively small turning radius, and their unique ability to provide good DX performance when mounted close to the earth. A two-element three-band quad, for instance, with the elements

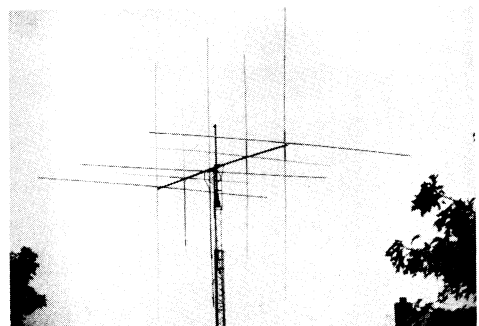

Fig. 9-8 - The three-band quad antenna.

TABLE 9-1					
Three-Band Quad Loop Dimensions					
Band	Reflector	Driven Element	First Director	Second Director	Third Director
20 Meters	(A) 72' 8"	(B) 71' 3"	(C) 69' 6"	—	—
15 Meters	(D) 48' 6½"	(E) 47' 7½"	(F) 46' 5"	(G) 46' 5"	—
10 Meters	(H) 36' 2½"	(I) 35' 6"	(J) 34' 7"	(K) 34' 7"	(L) 34' 7"

Letters indicate loops identified in Fig. 9-9.

mounted only 35 feet above the ground, will give good performance in situations where a triband Yagi will not. Fig. 9-8 shows a large quad antenna which can be used as a basis for design for either smaller or larger arrays.

Five sets of element spreaders are used to support the three-element 20-meter, four-element 15-meter, and five-element 10-meter wire-loop system. The spacing between elements has been chosen to provide optimum performance consistent with boom length and mechanical construction. Each of the parasitic loops is closed (ends soldered together) and requires no tuning. All of the loop sizes are listed in Table 9-1 and are designed for a center frequency of 14.1, 21.1, and 28.3 MHz. Since quad antennas are rather broad-tuning devices excellent performance is achieved in both cw and ssb band segments of each band (with the possible exception of the very high end of 10 meters). Changing the dimensions to favor a frequency 200 kHz higher in each band to create a "phone" antenna is not necessary.

The most obvious problem related to quad antennas is the ability to build a structurally sound system. If high winds or heavy ice are a normal part of the environment, then special precautions

are necessary if the antenna is to survive a winter season. Another stumbling block for would-be quad builders is the installation of a three dimensional system (assuming a Yagi has only two important dimensions) on top of a tower — especially if the tower needs guy wires for support. With proper planning, however, many of these obstacles can be overcome, i.e., a tram system may be used (see Eichman, *QST*, March, 1974).

One question which comes up quite often is whether to mount the loops in a diamond or a square configuration. In other words, should one spreader be horizontal to the earth, or should the wire be horizontal to the ground (spreaders mounted in the fashion of an X)? From the electrical point of view, it is probably a trade-off. While the square configuration has its lowest point higher above ground than a diamond version (which may lower the angle of radiation slightly), the top is also lower than that of a diamond shaped array. Some authorities indicate that separation of the current points in the diamond system gives slightly more gain than is possible with a square layout. It should be pointed out, however, that there never has been any substantial proof in favor of one of the other, electrically.

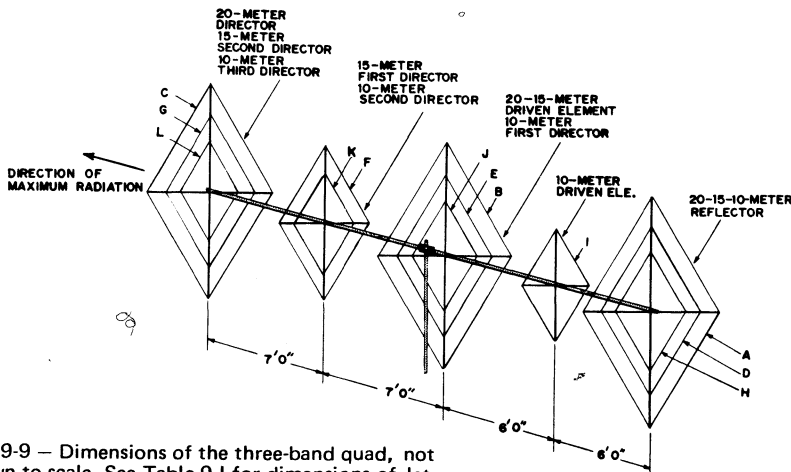

Fig. 9-9 — Dimensions of the three-band quad, not drawn to scale. See Table 9-1 for dimensions of lettered wires.

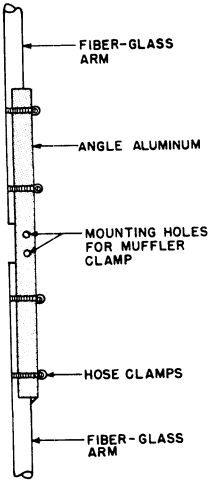

Fig. 9-10 — Details of one of two assemblies for a spreader frame. The two assemblies are joined to form an X with a muffler clamp mounted at the position shown.

From the mechanical point of view there is no question which version is better. The diamond quad, with the associated horizontal and vertical spreader arms, is capable of holding an ice load much better than a system where no vertical support exists to hold the wire loops upright. Stated differently, the vertical poles of a diamond array, if sufficiently strong, will hold the rest of the system erect. When water droplets are accumulating and forming into ice, it is very reassuring to see water running down the wires to a corner and dripping off, rather than just sitting there on the wires and freezing. The wires of the loop (or several loops, in the case of a multiband antenna) help support the horizontal spreaders under a load of ice. A square quad will droop severely under heavy ice conditions because there is nothing to hold it up straight.

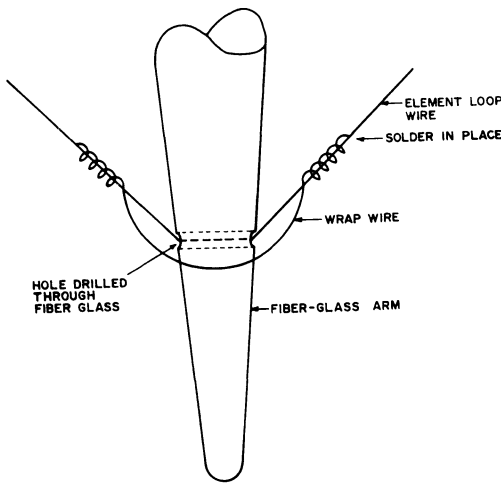

Fig. 9-11 — A method of assembling a corner of the wire loop of a quad element to the spreader arm.

Another consideration enters into the selection of a design for a quad. The support itself, if guyed, will require a diamond quad to be mounted a short distance higher on the mast or tower than an equivalent square array if the guy wires are not to interfere with rotation.

The quad array shown in Fig. 9-8 uses fiber-glass spreaders available from Kirk Electronics, East Haddam, Connecticut. Bamboo is a suitable substitute (if economy is of great importance). However, the additional weight of the bamboo spreaders over fiber glass is an important consideration. A typical 12-foot bamboo pole weighs about two pounds; the fiber-glass type weighs less than a pound. By multiplying the difference times eight for a two-element array, 12 times for a three-element antenna, and so on, it quickly becomes apparent

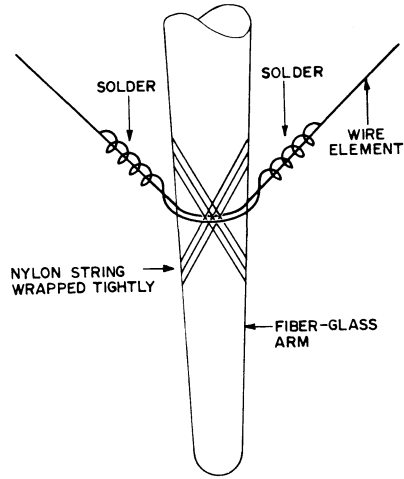

Fig. 9-12 — An alternative method of assembling the wire of a quad loop to the spreader arm.

that fiber glass is worth the investment if weight is an important factor. Properly treated, bamboo has a useful life of three or four years, while fiber-glass life is probably ten times that amount.

Spreader supports (sometimes called spiders) are available from many different manufacturers. If the builder is keeping the cost at a minimum, he should consider building his own. The expense is about half that of a commercially manufactured equivalent and, according to some authorities, the homemade arm supports described below are less likely to rotate on the boom as a result of wind pressure.

A three-foot long section of one-inch-per-side steel angle stock is used to interconnect the pairs of spreader arms. The steel is drilled at the center to accept a muffler clamp of sufficient size to clamp the assembly to the boom. The fiber glass is attached to the steel angle stock with automotive hose clamps, two per pole. Each quad-loop spreader frame consists of two assemblies of the type shown in Fig. 9-10.

Connecting the wires to the fiber glass can be done in a number of different ways. Holes can be

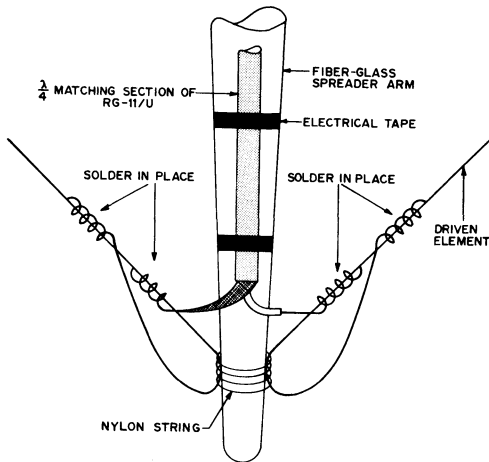

Fig. 9-13 — Assembly details of the fed element of a quad loop.

drilled at the proper places on the spreader arms and the wires run through them. A separate wrap wire should be included at the entry/exit point to prevent the loop from slipping. Details are presented in Fig. 9-11. Some amateurs have experienced cracking of the fiber glass, which might be a result of drilling holes through the material. However, this seems to be the exception rather than the rule. The model described here has no holes in the spreader arms; the wires are attached to each arm with a few layers of plastic electrical tape and then wrapped approximately 20 times in a crisscross fashion with 1/8-inch diameter nylon string, as shown in Fig. 9-12. The wire loops are left open at the bottom of each driven element where the coaxial cable is attached. See Fig. 9-13. All of the parasitic elements are continuous loops of wire; the solder joint is at the base of the diamond.

A triband system requires that each driven element be fed separately. Two methods are

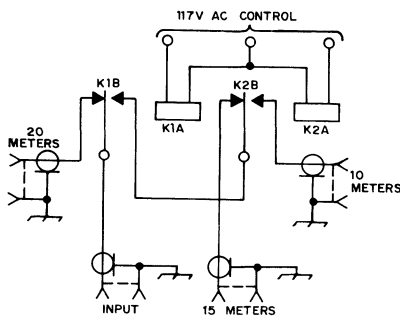

Fig. 9-14 — Suitable circuit for relay switching of bands for the three-band quad. A 3-wire control cable is required. K1, K2 — Any type of relay suitable for rf switching, coaxial type not required (Potter and Brumfeld MR11A acceptable; although this type has double-pole contacts, mechanical arrangements of most single-pole relays make them unacceptable for switching of rf).

possible. First, three individual sections of coaxial cable may be used. Quarter-wave transformers of 75-ohm line are recommended for this service. Second, a relay box may be installed at the center of the boom. A three-wire control system may be used to apply power to the proper relay for the purpose of changing bands. The circuit diagram of a typical configuration is presented in Fig. 9-14, and its installation is shown in Fig. 9-15.

The quarter-wave transformers mentioned above are necessary to provide a match between the wire loop and a 50-ohm transmission line. It is simply a section of 75-ohm coax cable placed in series between the 50-ohm line and the antenna feed point, as shown in Fig. 9-16. A pair of PL-259 connectors and a barrel interconnector may be used to splice the cables together. The connectors and the barrel should be wrapped well with plastic tape and then sprayed with acrylic for protection against the weather.

Every effort must be placed upon proper construction if freedom from mechanical problems is to be expected. Hardware must be secure or vibrations created by the wind may cause unjoining of assemblies. Solder joints should be clamped in place to keep them from flexing, which might fracture a connection point.

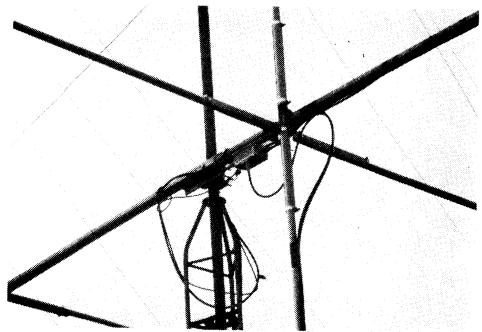

Fig. 9-15 — The relay box is mounted on the boom near the center. Each of the spreader-arm fiber-glass poles is attached to steel angle stock with hose clamps.

## THE LOG-PERIODIC DIPOLE ARRAY

The antenna system shown in Figs. 9-17 and 9-18 was originally described in *QST* for November, 1973. Additional information on the design of a log-periodic dipole array (LPDA) is given in Chapter Four.

The characteristics of the triband antenna are:

- Frequency range, 13-30 MHz
- Half-power beamwidth,  $43^\circ$  (14 MHz)
- Operating bandwidth,  $B = 30/13 = 2.3$
- Design parameter  $\tau = 0.9$
- Relative element spacing constant  $\sigma = .05$
- Apex half-angle  $\alpha = 25^\circ$ ,  $\cot \alpha = 2.0325$
- Bandwidth of active group,  $B_{ar} = 1.4$
- Bandwidth of structure,  $B_s = 3.22$
- Boom length,  $L = 26.5$  ft



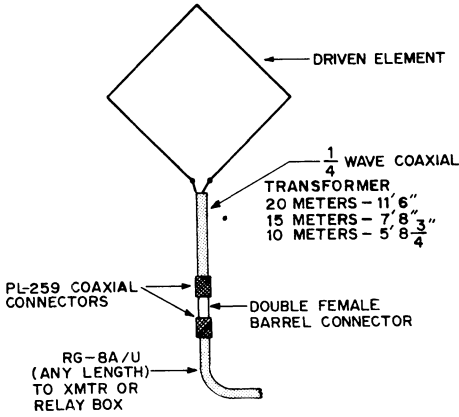

Fig. 9-16 - Showing installation of quarter-wave 75-ohm transformer section.

Longest element  $l_1 = 38$  ft (a tabulation of element lengths and spacings is given in Table 9-II)  
 Total weight, 116 pounds  
 Wind-load area, 10.7 sq. ft  
 Required input impedance (mean resistance),  $R_o = 67$  ohms,  $Z_t = 6$ -inch jumper No. 18 wire  
 Average characteristic dipole impedance:  $Z_{a14}$  MHz = 450 ohms;  $Z_{a21}$  MHz = 420 ohms;  $Z_{a28}$  MHz = 360 ohms  
 Mean spacing factor  $\sigma' = .0527$   
 Impedance of the feeder:  $Z_{o14}$  MHz = 95 ohms;  $Z_{o21}$  MHz = 97 ohms;  $Z_{o28}$  MHz = 103 ohms  
 Using a toroid balun at the input terminals and a 72-ohm coax feeder the SWR is 1.4 to 1 (maximum).

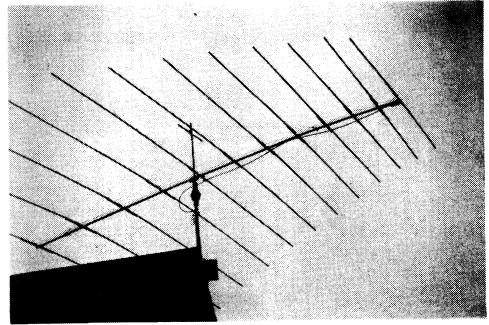

Fig. 9-17 - The log-periodic dipole array (K4EWG).

The mechanical assembly uses materials readily available from most local hardware stores or aluminum supply houses. The materials needed are given in Table 9-III. In the construction diagram, Fig. 9-18, the materials are referenced by their respective material list number. The photograph shows the overall construction picture, and the drawings show the details. Table 9-IV gives the required tubing lengths to construct the elements.

**Bibliography**

- Source material and more extended discussion of topics covered in this chapter can be found in the references given below.
- Bergren, "The Multielement Quad," *QST*, May, 1963.
- Reynolds, "Simple Gamma Match Construction," *QST*, July, 1957.
- Rhodes, "The Log-Periodic Dipole Array," *QST*, November, 1973.

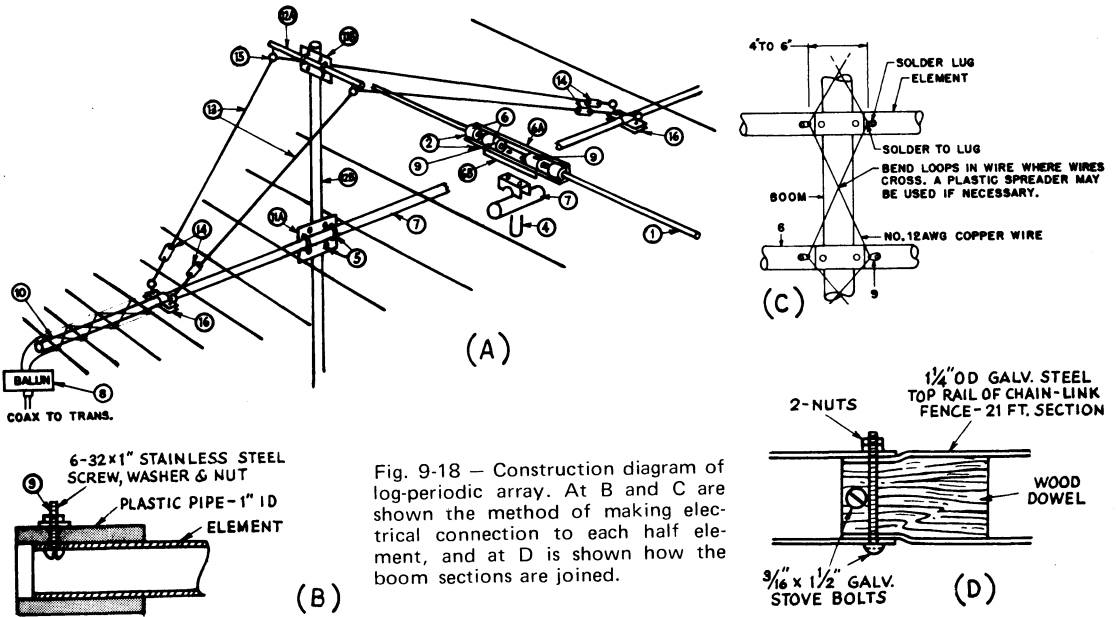

Fig. 9-18 - Construction diagram of log-periodic array. At B and C are shown the method of making electrical connection to each half element, and at D is shown how the boom sections are joined.

**TABLE 9-II – ARRAY DIMENSIONS, FEET**

<i>El. No.</i>	$l_n$	$h$	$d_{n-1,n}$ (spacing)	<i>nearest resonant</i>
1	38.0	19	0	
2	34.2	17.1	3.862 = $d_{12}$	14 MHz
3	30.78	15.39	3.475 = $d_{23}$	
4	27.7	13.85	3.13	.
5	24.93	12.465	2.815	.
6	22.44	11.22	2.533	.
7	20.195	10.098	2.28	.
8	18.175	9.088	2.05	.
9	16.357	8.179	1.85	.
10	14.72	7.36	1.663	.
11	13.25	6.625	1.496	.
12	11.924	5.962	1.347 = $d_{11,12}$	21 MHz

**TABLE 9-III – MATERIALS LIST**

<i>Material Description</i>	<i>Quantity</i>		
1. Aluminum tubing – .047" wall thickness 1" – 12' or 6' lengths 7/8" – 12' lengths 7/8" – 6' or 12' lengths 3/4" – 8' lengths	126 lineal feet 96 lineal feet 66 lineal feet 16 lineal feet	7. 1-1/4" top rail of chain-link fence	26.5 lineal feet
2. Stainless-steel hose clamps – 2" max.	48 ea.	8. 1:1 toroid balun	1 ea.
3. Stainless-steel hose clamps – 1-1/4" max.	26 ea.	9. 6 – 32 x 1" stainless-steel screws 6 – 32 stainless-steel nuts No. 6 solder lugs	24 ea. 48 ea. 24 ea.
4. TV-type U-bolts	14 ea.	10. No. 12 copper feeder wire	60 lineal feet
5. U-bolts, galv. type 5/16" x 1-1/2" 1/4" x 1"	4 ea. 2 ea.	11. A. 12" x 8" x 1/4" aluminum plate B. 6" x 4" x 1/4" alum. plate	1 ea. 1 ea.
6. 1" ID polyethylene water-service pipe – 160 psi test, approx. 1-1/4" OD A. 1-1/4" x 1-1/4" x 1/8" aluminum angle – 6' lengths B. 1" x 1/4" aluminum bar – 6' lengths	20 lineal feet 30 lineal feet 12 lineal feet	12. A. 3/4" galv. pipe B. 1" galv. pipe – mast	3 lineal feet 5 lineal feet
		13. Galv. guy wire	50 lineal feet
		14. 1/4" x 2" turnbuckles	4 ea.
		15. 1/4" x 1-1/2" eye bolts	2 ea.
		16. TV guy clamps and eye bolts	2 ea.

**TABLE 9-IV – ELEMENT MATERIAL REQUIREMENTS**

<i>El. No.</i>	<i>1" tubing</i>		<i>7/8" tubing</i>		<i>3/4" tubing</i>		<i>1-1/4" angle</i>	<i>1" bar</i>
	<i>Lth.</i>	<i>Qty.</i>	<i>Lth.</i>	<i>Qty.</i>	<i>Lth.</i>	<i>Qty.</i>	<i>Lth.</i>	<i>Lth.</i>
1	6'	2	6'	2	8'	2	3'	1'
2	6'	2	12'	2	–	–	3'	1'
3	6'	2	12'	2	–	–	3'	1'
4	6'	2	8.5'	2	–	–	3'	1'
5	6'	2	7'	2	–	–	3'	1'
6	6'	2	6'	2	–	–	3'	1'
7	6'	2	5'	2	–	–	2'	1'
8	6'	2	3.5'	2	–	–	2'	1'
9	6'	2	2.5'	2	–	–	2'	1'
10	3'	2	5'	2	–	–	2'	1'
11	3'	2	4'	2	–	–	2'	1'
12	3'	2	4'	2	–	–	2'	1'

# HF Antennas for Restricted Space

It is not always practical to erect full-size antennas for the hf bands. Those who live in apartment buildings may be restricted to the use of minuscule radiators because of house rules, or simply because the required space for full-size antennas does not exist. Other amateurs may desire small antennas for aesthetic reasons, perhaps to prevent the neighbors in their residential areas from becoming annoyed at the sight of a high tower and beam antenna of full dimensions. There are many reasons why some amateurs prefer to use physically shortened antennas, and this chapter offers information of various schemes that can be employed to realize that goal.

It is important to consider that few compromise antennas are capable of delivering the performance one can expect from the full-size variety. But the patient and skillful operator can often do as well as some fellows who are equipped with high power and full-size antennas. The former may not be able to "bore a hole" in the band as often, and with the commanding dispatch enjoyed by his well-equipped brothers, but DX can be worked successfully when band conditions are suitable.

## "Invisible" Antennas

Situations arise in nearly every amateur's life which call for discreet antenna installations. That is, rather than arouse the ire of some neighboring nonamateur, it might save a lot of explanation and discussion merely to put up a temporary radiating system which does not resemble the classic wire antenna. A 120-foot length of No. 28 enamel wire, strung between the window of a motel unit and some supporting object at the far end, will usually

Fig. 10-1 — Dipole antenna lengthened electrically with off-center loading coils. For a fixed dimension  $A$ , greater efficiency will be realized with greater distance  $B$ , but as  $B$  is increased,  $L$  must be larger in value to maintain resonance. If the two coils are placed at the ends of the antenna, in theory they must be infinite in size to maintain resonance. Capacitive loading of the ends, either through proximity of the antenna to other objects or through the addition of capacitance hats, will reduce the required value of the coils.

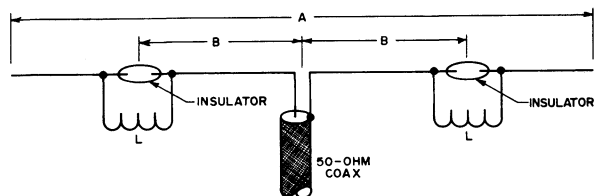

pass without being observed, and will provide good performance if matched to the transmitter.

A primary consideration with any antenna system, makeshift or permanent, is safety to those who might come in contact with the system. Always keep the antenna well out of reach. The QRP operator who uses only one or two watts of power is not likely to create a hazardous situation with his antenna, but should observe the rules of safety just the same.

Another invisible antenna can be realized by erecting a flagpole and using it as a vertical antenna. Alternatively, the halyard can be the kind of plastic clothesline which contains a wire core, the halyard, thereby, serving as the antenna. The latter is especially useful when wooden or fiber-glass flagpoles are used. Hollow, nonmetallic flagpoles lend themselves nicely to containing an internal wire or length of copper tubing which can be used as an antenna.

Another possibility which should not be overlooked is that of using the TV antenna and its feed line as a vertical antenna. The antenna and feeder should be insulated from the supporting mast, and standoff insulators should be used to keep the 300-ohm Twin-Lead from touching the house or other objects. The entire antenna system can be tuned to hf-band resonance by means of a Transmatch and treated as a random-length wire. In the interest of safety, the supporting mast or tower should be grounded. A high-quality lightning arrester should be used between the feed line and the grounded mast. Vhf operators can modify many TV antennas to work as beam antennas on 6 or 2 meters by cutting the elements to the correct length and adding a matching device, such as a quarter-wave universal stub.

Some amateurs have reported good results when using the downspout and gutter system of a wooden house as a radiator in hf-band work. Still others have used plastic clothesline (with a steel

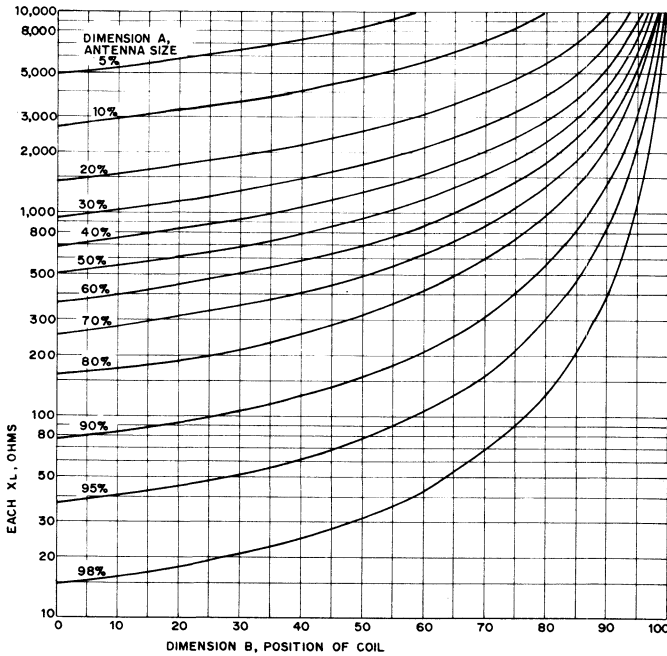

Fig. 10-2 — Chart for determining approximate inductance values for off-center-loaded dipoles. At the intersection of the appropriate curve from the body of the chart for dimension *A* and the proper value for the coil position from the horizontal scale at the bottom of the chart, read the required inductive reactance for resonance from the scale at the left. See Fig. 10-1. Dimension *A* is expressed as percent length of the shortened antenna with respect to the length of a half-wave dipole of the same conductor material. Dimension *B* is expressed as the percentage of coil distance from the feed point to the end of the antenna. For example, a shortened antenna which is 50% or half the size of a half-wave dipole (one-quarter wavelength overall) with loading coils positioned midway between the feed point and each end (50% out) would require coils having an inductive reactance of approximately 950 ohms at the operating frequency for antenna resonance.

core) between the clothes poles in the back yard, placing an insulator at each point where the line is supported by a pole.

Enterprising amateurs should be able to contrive many schemes for installing invisible antennas. The possibilities are unlimited. But always — *Safety First!*

**Indoor Systems**

Perhaps the simplest indoor antenna one can use is the attic-installed random-length wire. For single-band use it is convenient to install a Trans-

match in the attic and bring coaxial cable down from the antenna system to the operating position. It is seldom practical to route the radiating portion of a wire antenna through the walls to some lower level in the house. Electrical wiring and water pipes will have an adverse effect on the efficiency of the antenna.

Physically shortened dipoles are practical and should be of interest to the indoor-antenna user. When there is insufficient area to mount a full-size dipole, one can install a loading inductor in each leg of the doublet and tune the system to resonance by adjusting the number of coil turns. Fig. 10-1 is a drawing of such an antenna. The longer the overall length, dimension *A*, and the farther the loading coils are positioned from the center of the antenna, dimension *B*, the greater the efficiency of the antenna. However, the greater is distance *B* (for a fixed overall antenna size), the larger the inductors must be to maintain resonance. Approximate inductance values for single-band resonance may be determined with the aid of Fig. 10-2, but the final values will depend upon the proximity of surrounding objects in individual installations and must be determined experimentally. The use of high-Q low-loss coils is suggested. A grid-dip meter, Macromatcher, or SWR indicator is recommended for use during adjustment of the system.

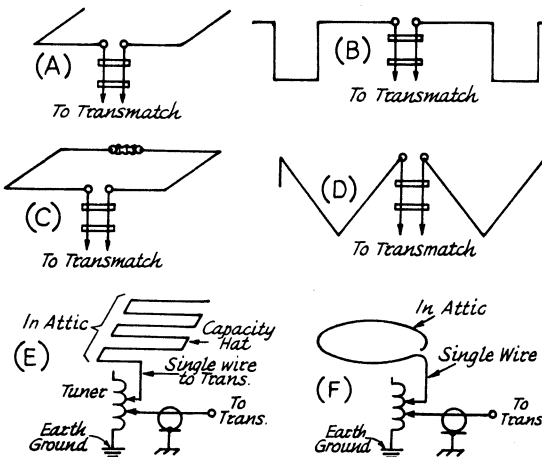

Fig. 10-3 — Various configurations for small indoor antennas. A discussion of installation and tuning methods is contained in the text.

If the attic area is large enough to accommodate an almost full-size dipole, simply erect as much of the antenna as possible in a straight line,

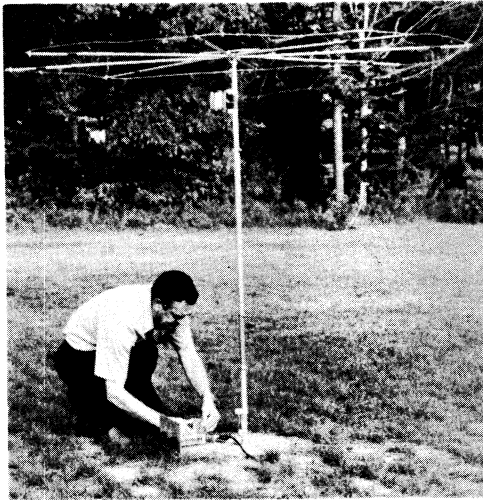

Fig. 10-4 — W2FMI adjusts the 6-foot, 40-meter vertical.

then bend the ends of the dipole up, down, or sideways from the main portion of the system. It is recommended that the installer attempt to maintain symmetry in the system by bending the ends of the antenna in equal amounts. Some ideas for indoor installations can be gained from Fig. 10-3.

Some amateurs living in wooden-frame dwellings have enjoyed reasonable success when loading the metal screen of a large window. Here again, a Transmatch is almost mandatory in tuning the window screen to resonance. The ground system can be the cold-water pipes, the third wire (ground) of the electrical system, or both.

**Outdoor Antennas**

It is possible to reduce the physical size of an antenna by 50% or more and still obtain good results. Use of an outdoor off-center-loaded dipole, as described in the previous section, will permit a city-size lot to accommodate a doublet antenna on the lower frequency hf bands, 40, 80, or even 160 meters. Short vertical antennas can also be made quite effective by using lumped inductance to obtain resonance, and by using a capacitance hat to increase the feed-point impedance of the system. As is the case with full-size vertical quarter-wave antennas, the ground-radial network should be as effective as possible. Ground-mounted vertical radiators should be used in combination with several buried radials. Above-ground vertical antennas should be worked against at least four quarter-wavelength radials.

**A SIX-FOOT-HIGH 40-METER VERTICAL ANTENNA**

Figs. 10-4 through 10-7 give details for building short, effective vertical quarter-wavelength radia-

tors. The information gathered and presented here was provided by Sevick, W2FMI. (See the bibliography for reference to his *QST* articles on the subject of shortened antennas.)

A short vertical antenna, properly designed and installed, approaches the efficiency of a full-size resonant quarter-wave antenna. Even a six-foot vertical on 40 meters can produce an exceptional signal. Theory tells us that this should be possible, but the practical achievement of such a result requires an understanding of the problems of ground losses, loading, and impedance matching, treated in the theory chapters of this book.

The key to success with shortened vertical antennas lies in the efficiency of the ground system with which the antenna is used. A system of 60 wire radials is recommended for best results, though the builder may want to reduce the number at some expense to performance. The radials can be tensioned and pinned at the far ends to permit on-the-ground installation, which will enable the amateur to mow the lawn without the wires becoming entangled in the mower blades. Alternatively, the wires can be buried in the ground where they will not be visible. There is nothing critical about the wire size for the radials. No. 28, 22, or even 15-gauge, will provide the same results. The radials should be at least 0.2 wavelength long (27 feet or greater.)

A top hat is formed as illustrated in Fig. 10-5. The diameter is 7 feet, and a continuous length of wire is connected to the spokes around the outer circumference of the wheel. A loading coil consisting of 14 turns of B&W 3029 Miniductor stock (2-1/2 inch dia, 6 TPI, No. 12 wire) is installed six inches below the top hat (see Fig. 10-4). This antenna exhibits a feed-point impedance of 3.5 ohms at 7.21 MHz. For operation above or below this frequency, the number of coil turns must be decreased or increased, respectively. Matching is

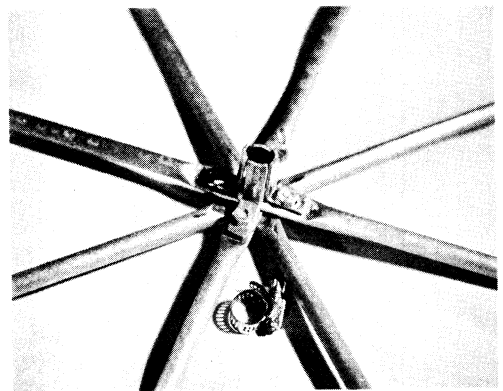

Fig. 10-5 — Construction details for the top hat. For a diameter of 7 feet, half-inch aluminum tubing is used. The hose clamp is of stainless steel and available at Sears. The rest of the hardware is aluminum.

accomplished by increasing the feed-point impedance to 14 ohms through addition of a 4:1 transformer, then matching 14 ohms to 50 ohms (feeder impedance) by means of a pi network. Bandwidth for this antenna is approximately 100 kHz (range of frequency where SWR is less than 2:1).

More than two hundred contacts with the six-foot antenna have strongly indicated the efficiency and capability of a short vertical. Invariably at distances greater than 500 or 600 miles, the short vertical yielded excellent signals. Similar antennas can be scaled and constructed for bands other than 40 meters. The 7-ft-dia top hat was tried on an 80-m vertical, with an antenna height of 22 ft. The loading coil had 24 turns and was placed two feet below the top hat. On-the-air results duplicated those on 40 meters. The bandwidth was 65 kHz.

Short verticals such as these have the ability to radiate and receive almost as well as a full-size quarter-wave antenna. The differences are practically negligible. Trade-offs are in lowered input impedances and bandwidths. However, with a good image plane and a proper design, these trade-offs can be entirely acceptable.

## THE DRRR ANTENNA

Another physically small but effective antenna is the DRRR (directional discontinuity ring radiator), described in *Electronics*, January, 1963. An in-depth mathematical analysis of this low-profile antenna was given by Dome in *QST* for July, 1972. Fig. 10-8 shows details for constructing a DRRR antenna.

In this example the radiating element of the antenna is made from two-inch diameter automo-

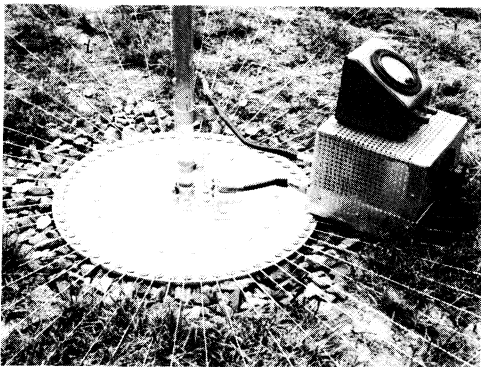

Fig. 10-7 — Base of the vertical antenna showing the 60 radials. The aluminum disk is 15 inches in diameter and 1/4-inch thick. Sixty tapped holes for 1/4-20 aluminum hex-head bolts form the outer ring and 20 form the inner ring. The insulator is polystyrene material (phenolic or Plexiglas suitable) with a one-inch diameter. Also shown is the impedance bridge used for measuring input resistance.

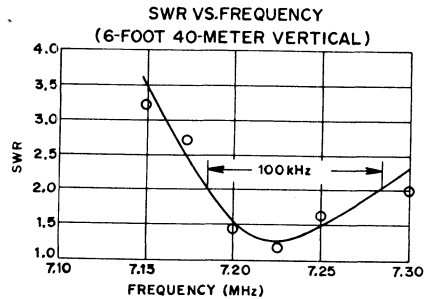

Fig. 10-6 — Standing-wave ratio of the six-foot vertical using a 7-foot top hat and 14 turns of loading 6 inches below the top hat.

bile exhaust pipe. Most muffler shops can supply the materials as well as bend the pipe to specifications. Table 10-1 lists the dimensions required for operation from 160 to 2 meters, inclusive. The following technique illustrates how a 40-meter model can be assembled (from English, W6WYQ, *QST* for Dec., 1971).

In forming the ring to these dimensions, four 10-foot lengths of tubing are used. A 10-degree bend is made at 9-inch intervals in three of the lengths. The fourth length is similarly treated except for the last 18 inches which is bent at right angles to form the upright leg of the ring. One end of each section is flared so that the sections can be coupled together by slipping the end of one into the flare of its mate.

The required flares are easily made at the muffler shop with the aid of the forming tools. Another task which can best be completed at the shop is to weld a flange onto the end of the upright leg. This flange is to facilitate attaching the leg to the mounting plate which provides a chassis for the tuning mechanism and the coaxial-feed coupler. After bending and flaring is complete, the ring is assembled and minor adjustments made to bring it into round and to the proper dimensions. This can best be done by drawing a circle on the floor with chalk and fitting the ring inside the circle. The circle must be slightly larger than the center-to-center diameter so that the reference line can be seen easily. For example, with two-inch tubing the diameter of the reference circle must be 9 feet, 2 inches. When a satisfactory fit is obtained between the tubing ring and the chalk ring, drill a 1/4-inch hole through each of the joints to accept a 1/4-inch bolt. These bolts will clamp the sections together. Also, they can be used to attach the insulators which support the ring at a fixed height above the ground plane.

Insulators for the antenna are made from 11-inch lengths of 2-inch PVC pipe inserted into a standard cap of the same material. The PVC caps are first drilled through the center to accept the 1/4-inch bolt previously installed at the joints. The caps are then slipped onto the bolts and nuts are installed and tightened to secure the caps in place.

**TABLE 10-1**  
**Dimensions for 1/4-Wavelength DDDR Elements**

<i>Band (Meters)</i>	160	80	40	20	15	10	6	2
<i>Feed Point (FP)*</i>	12"	6"	6"	2"	1.5"	3"	1"	1/2"
<i>Gap (G)</i>	16"	7"	5"	3"	2.5"	2"	1.5"	1"
<i>Capacitor, pF (C)</i>	150	100	70	35	15	15	10	5
<i>Spacing (Height) (SP)</i>	48"	24"	11"	6"	4 3/4"	3"	1 1/2"	1"
<i>Tubing Diameter (D)</i>	5"	4"	2"	1"	3/4"	3/4"	1/2"	1/4"
<i>Ring Diameter (RD)</i>	36'	18'	9'	4.5'	3'4"	2'4"	16 1/4"	6"

\*See Fig. 10-8 for explanation of designations.

The 11-inch length of pipe, when inserted into the cap and pressed firmly until it touches bottom, results in a total insulator length of 12 inches. Four insulators are required, one at each of the joints and one near the open end of the ring for support. It is wise to locate this insulator as far back from the end of the ring as possible because of the increasing high rf voltage that develops as the end of the ring is approached.† As a final measure, the bottom ends of the insulators are sealed to prevent moisture from forming on the inside surfaces. Standard PVC caps may be used here, but plastic caps from 15-ounce aerosol cans fit well.

A mounting plate is required to provide good mechanical and electrical connections for the grounded leg of the radiator, the coaxial feed-line connection, and the tuning mechanism. If you are using aluminum tubing, you should use an aluminum plate, and for steel tubing, a steel plate to lessen corrosion from the contacting of dissimilar metals. Dimensions for the plate are shown in Fig. 10-10. The important consideration here is that good, solid mechanical and electrical connections are made between the ground side at the coaxial connector, the ring base, and the tuning capacitor.

In the installation shown in Fig. 10-9 the 9-foot ring resonated easily with approximately 20 pF of capacitance between the high end of the ring and the base plate or ground. Any variable capacitor which will tune the system to resonance and which will not arc under full power should be satisfactory. Remember, the rf voltage at the high impedance end of this antenna can reach 20 to 30 kV with high power, so if you are using the maximum legal limit, you would do well to consider using a vacuum variable capacitor. To provide for full band coverage, a 35-pF variable capacitor was coupled to a reversible, slow-speed motor which enabled the antenna to be tuned remotely from the operating position in the antenna pictured. An indicated SWR of 1.1 to 1 was achieved easily over the entire 40-meter band. The motor used was a surplus item made by Globe Industries of Dayton, Ohio. At 20

† Because of the danger of rf burns in the event of accidental contact with the antenna, precautions should be taken to prevent random access to the completed installation.

volts dc the shaft of this motor turns at about 1 rpm, which is ideal for DDDR tuning. The gears used were surplus items. If you cannot obtain gears, string and pulley drive will do almost as well, or you can mount both the motor and the capacitor in line and use direct coupling. Of course, if you operate on a fixed frequency, or within a 40- to 50-kHz segment of the band, you can dispense with the motor entirely and simply tune the capacitor manually. In any case, the tuning unit must be protected from the weather. A plastic refrigerator box may be used to house the tuning capacitor and its drive motor.

**Electrical Connections and the Ground Plane**

The connection between the open end of the ring and the tuning capacitor is made with No. 12 wire or larger. On the end of the base plate opposite the tuning unit, and directly under the ring about 8 inches from the grounded post, install a bracket for a coaxial connector. The connector should be oriented so that the feed line will lead away from the ring at close to 90 degrees. Install a

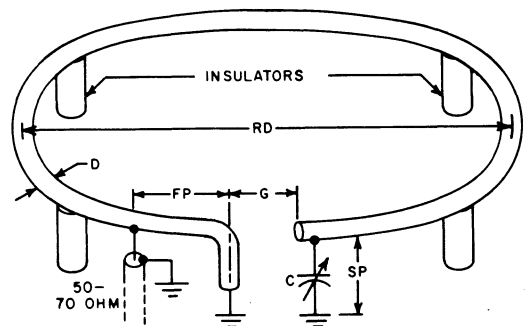

Fig. 10-8 — RD = 0.078λ(28°); SP = 0.11D (2.5°); FP = 0.25SP (see Note 1); C = (see Note 2); D = (see Note 3); G = (see Table 10-1). Notes: (1) Actual dimension must be found experimentally. (2) Value to resonate the antenna to the operating freq. (3) D ranges upward from 1/2". The larger D is, the higher the efficiency is. Use largest practical size, e.g., 1/2" for 10 meters, 5" or 6" for 80 or 160 meters.

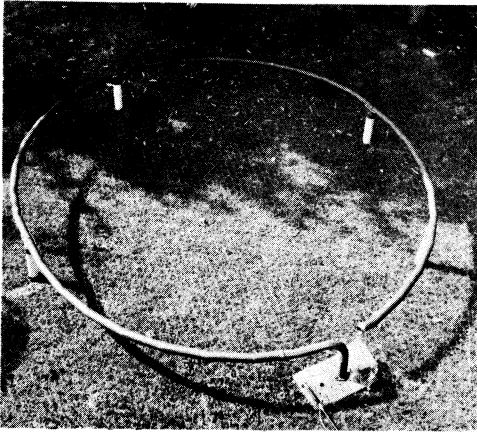

Fig. 10-9 — The chicken-wire ground plane is evident in the background. The base plate can be seen at lower right. Note the relative positions of the 52-ohm coaxial feed at the left end of the plate, the flange on the foot of the post, and the tuning unit at the right hand end of the plate.

clamp on the ring directly above the coaxial connector. Connect a lead of No. 12 or larger wire from the coaxial connector to the clamp. This wire must have a certain amount of flexibility to accommodate the movement necessary when adjusting the match. The matching point must be found by experimentation. It will be affected by the nature and quality of the ground plane over which the antenna is operating. The antenna will function over earth ground, but a ground-plane surface of chicken wire (laid under the antenna and bonded to the base plate) will provide a constant ground reference and improved performance. In a roof-top location sheet-metal roofing should provide an excellent ground plane. A poor ground usually results in a matching point for the feed line far out along the circumference of the circle. In the

installation shown a near-perfect match was obtained with the feed line connected to the ring about 12 inches from the grounded post. During testing, when the antenna was set up on a concrete surface without the ground plane, a match was found when the feed line was connected nearly 7 feet from the post!

As shown in the photo, the compactness of the antenna is readily apparent. The ground plane is made up of three 12-foot lengths of chicken wire, each 4 feet wide, which are bonded along the edges at about 6-inch intervals. In this installation the antenna, with the ground plane, could be dismantled in about 30 minutes. If portability is not important, it is best to bond all of the joints in the tubing so that good electrical continuity is assured.

After all construction is completed, the antenna should be given a coat of primer paint to minimize rust. If it suits you, there is no reason why a final coat of enamel could not be applied.

### Tuning Procedures

Once the mechanical construction is completed, the antenna should be erected in its intended operating location. Coupling to the station may be accomplished with either 52- or 72-ohm coaxial cable. Tune and load the transmitter as with any antenna. While observing an SWR meter in the line, operate the tuning motor. Indication of resonance is the noticeable decrease in indicated reflected power. At this point, note the loading of the transmitter; it will probably increase markedly as antenna resonance is approached. Retune the transmitter and move the feed-point tap on the antenna for a further reduction in indicated reflected power. There is interaction between the movement at the feed tap and the resonance point; therefore, it will be necessary to operate the tuning motor each time the tap is adjusted until the lowest SWR is achieved. Don't settle for anything less than 1.1 to 1. With a good ground and proper tuning and matching, this ratio can be achieved and maintained over the entire band. Once the proper

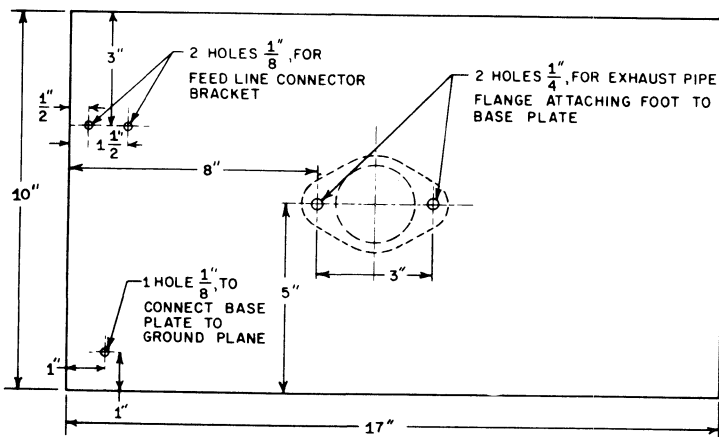

Fig. 10-10 — Drawing of the base plate which can be made from either steel or aluminum, as described in the text. The lower right portion of the plate may be used for the mounting of the tuning capacitor (and motor, if used).



feed point has been located, the only adjustment necessary when changing frequency is retuning the antenna to resonance by means of the motor. If the antenna is to be fixed tuned, provide an insulated shaft extension of 18 inches or so to the tuning-capacitor shaft for manual adjustment. This not only provides insulation from the high rf voltage but also minimizes body-capacitance effects during the tuning process.

**SHORTENED YAGI BEAM ANTENNA WITH LOADING COILS**

At some sacrifice in bandwidth it is practical to shrink the element dimensions of Yagi antennas. Resonance can be established through the use of loading inductors in the elements, or by using inductors in combination with capacitance hats. Though not as effective in terms of gain, the short Yagi beam offers the advantage of effective height above ground when compared to a wire dipole hung from a convenient near-earth support. When tower-mounted, the two-band Yagi of Figs. 10-11 through 10-15 requires only 22.5 feet maximum turning diameter for its 16-foot elements and boom. The antenna consists of interlaced elements for 15 and 20 meters. A driven element and reflector are used for 15-meter operation. The 20-meter section is comprised of a driven element and a director. Both driven elements are gamma

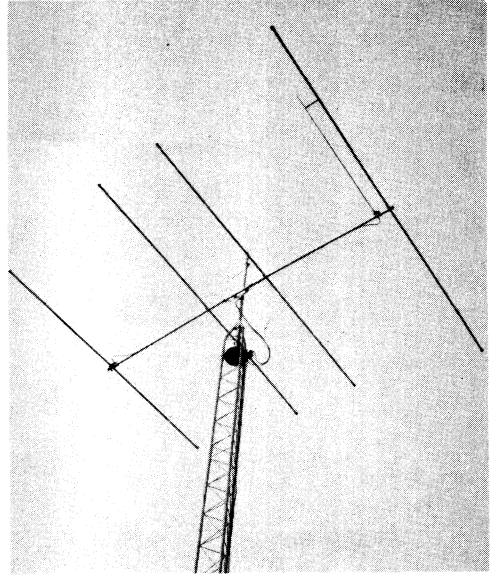

Fig. 10-11 — This short two-band Yagi can be turned by a light-duty rotator.

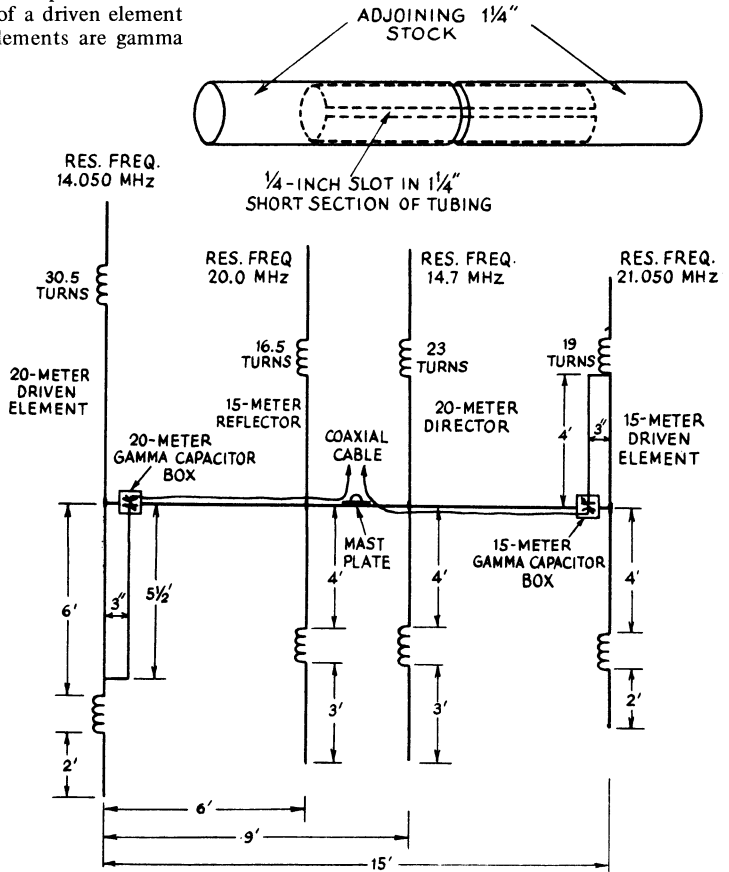

Fig. 10-12 — Constructional details for the 20- and 15-meter beam. The coils for each side of the element are identical. The gamma capacitors are each 140-pF variable units manufactured by E.F. Johnson Co. The capacitors are insulated from ground within the container. Since the antenna is one-half size for each band, the tuning is somewhat critical. The builder is encouraged to follow carefully the dimensions given here.

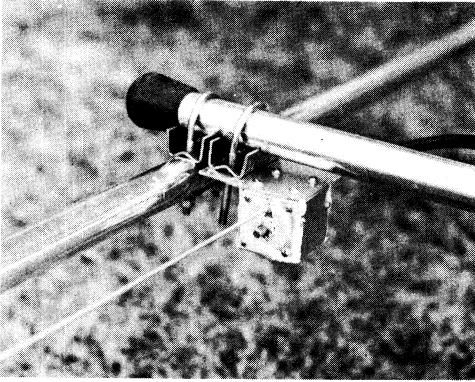

Fig. 10-13 — The gamma assembly is held in place by means of a small U bolt. The capacitors are mounted on etched circuit board.

matched. A low-cost TV antenna rotator has sufficient torque to handle this light-weight array. (From *QST* for September, 1973.)

A misconception among amateurs is that any element short of full size is no good in an antenna system. Reducing the size of an antenna by 50 percent does lower the efficiency by a decibel or two, but the gain capability of a parasitic array outweighs this small loss in efficiency. Mounting the antenna above the interference-generating neighborhood can greatly reduce susceptibility to man-made noise and certainly aids in the reduction of rf heating to trees, telephone poles, and buildings. Placing the antenna above these energy-absorbing objects is very desirable.

The dual-band beam has four elements, the longest of which is 16 feet. All of the elements and the boom are made from 1-1/4-inch diameter aluminum tubing available at most hardware stores. A complete parts list is given in Table 10-II. Element sections and boom pieces are joined together by slotting a 10-inch length of 1-1/4-inch tubing with a nibbling tool and compressing it for a snug fit inside the element and boom tubing. Coupling details are shown in Fig. 10-12.

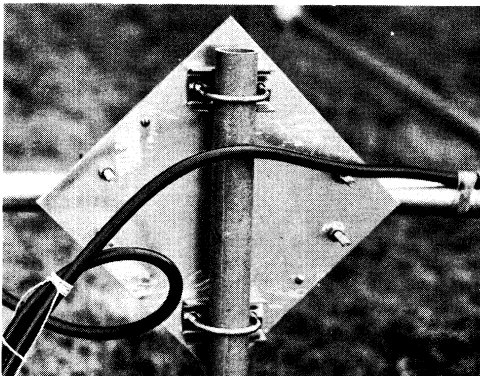

Fig. 10-15 — The boom-to-mast plate.

The loading coils are wound on 1-1/8-inch diameter Plexiglas rod. The rod slips into the element tubing and is held in place with compression clamps. Be sure to slit the end of the aluminum where the compression clamps are placed. See Fig. 10-14. The model shown in the photographs has coils made of surplus Teflon-insulated miniature audio coaxial cable with the shield braid and inner conductor shorted together. A suitable substitute would be No. 14 enameled copper wire wound to the same dimensions as those given in Fig. 10-12.

All of the elements are secured to the boom with common TV U-bolt hardware. Plated bolts are desirable to prevent rust from forming. A 1/4-inch thick boom-to-mast plate is constructed from a few pieces of sheet aluminum cut into 10-inch square sheets and held together with No. 8 hardware. Several cookie tins could be used if sheet aluminum is not available. A plate from a large electrical box might even be used as a boom-to-mast bracket. Since it is galvanized, it is quite resistant to harsh weather.

A boom strut (sometimes called a truss) is recommended because the weight of the elements is sufficient to cause the boom to sag a bit. A

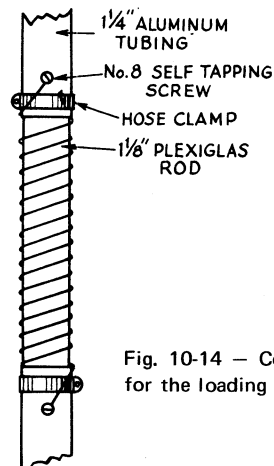

Fig. 10-14 — Construction details for the loading coils.

1/8-inch diameter nylon line is plenty strong. A U-bolt clamp is placed on the mast several feet above the antenna and provides the attachment point for the center of the truss line. To reduce the possibility of water accumulating in the element tubing and subsequently freezing (rupture may be the end result), crutch caps are placed over the element ends. Rubber tips suitable for keeping steel-tubing furniture from scratching hardwood floors would serve the same purpose.

A heavy-duty steel mast should be used, such as a one-inch-diameter galvanized water pipe. Steel TV mast is also acceptable. Any conventional TV type antenna rotator should hold up under load conditions presented by this antenna. Nevertheless, certain precautions should be taken to assure

continued trouble-free service. For instance, whenever possible, mount the rotator inside the tower and extend the mast through the tower top sleeve. This procedure relieves the rotator from having to handle lateral pressures during windy weather conditions. A thrust bearing is desirable to reduce downward forces on the rotator bearing.

The monoband nature of the beam requires the use of two coaxial feed lines. The coaxial cable is attached to the 15-meter element (at the front of the beam) at the gamma-capacitor box. The other end of the cable is connected to a surplus 28-V dc single-pole coaxial switch. The cable for the 20-meter element is connected in a similar fashion. The switch allows the use of a single feed line from the shack to a point just below the antenna where the switch is mounted. It is a simple matter to provide voltage to the switch for operation on one of the two bands. At the price of coaxial cable today, a double run of feed line represents a substantial investment and should be avoided if possible.

An etched circuit board was mounted inside an aluminum Minibox to provide support and insulation for each of the gamma tuning capacitors. Plastic refrigerator boxes available from most department stores would serve just as well. The capacitor housing is mounted to the boom by means of U bolts.

The builder is encouraged to follow the dimensions given in Fig. 10-12 as a starting point for the position of the gamma rods and shorting bar. Placing the antenna near the top of the tower and then tilting it to allow the capacitors to be reached makes it possible to adjust the capacitors for minimum SWR as indicated by an SWR meter (or power meter) connected in the feed line at the relay. If the SWR cannot be reduced below some nominal figure of approximately 1.1:1, a slight repositioning of the gamma short might be required. The dimensions given are for operation at 14.050 and 21.050 MHz. The SWR climbs above

**TABLE 10-II**  
**Complete Parts List for the Short Beam**

<i>QTY</i>	<i>MATERIAL</i>
9	Eight-foot lengths of aluminum tubing, 1-1/4" dia
11	U bolts
2	Variable capacitors, 140 pF (E.F. Johnson)
4'	Plexiglas cast rod, 1-1/8" dia
16	Stainless steel hose clamps, 1-1/2" dia
1	Aluminum plate, eight-inches square
10'	Aluminum solid rod, 1/4" dia
2	Refrigerator boxes, 4 x 4 x 4 inches
25'	Nylon rope, 1/8" dia
16	No. 8 sheet metal screws
16	No. 8 solder lugs
8	Plastic (or rubber) end caps, 1-1/4" dia

2:1 about 50 kHz in either direction from the center frequency. Although tests were not conducted at more than 150 watts input to the transmitter there is no reason why the system would not operate correctly with a kilowatt of power supplied to it.

After many months of testing this antenna, several characteristics were noted. During this period the antenna withstood several wind and ice storms. Performance is what can be expected from a two-element Yagi. The front-to-back ratio on 20 meters is a bit less than 10 dB. On 15 meters the front-to-back ratio is considerably better – on the order of 15 dB. Gain measurements were not made.

**A YAGI ANTENNA WITH HELICALLY WOUND ELEMENTS**

Another practical approach in building shortened Yagi antennas is the use of helically wound elements. Bamboo poles or fiber-glass quad anten-

Fig. 10-16 – The short beam with helically wound elements for 40 meters is shown here mounted on top of a 40-foot tower. A nylon-rope cross strut was not used with this installation and a slight amount of boom sag is noticeable.

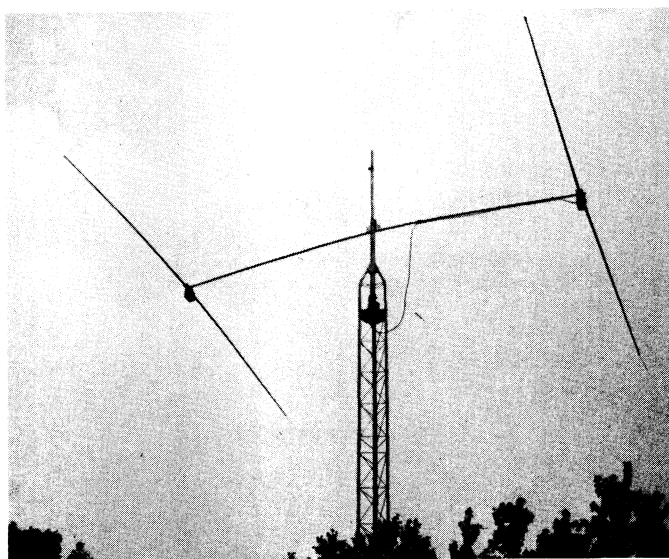

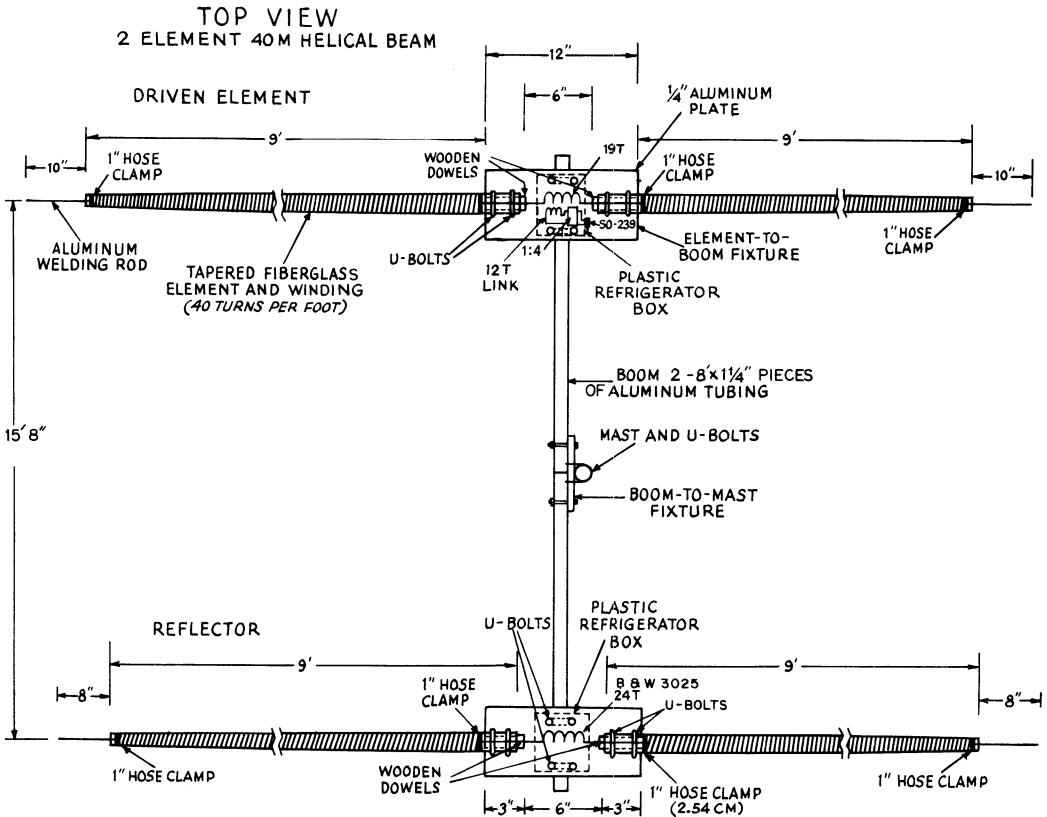

Fig. 10-17 — Overall dimensions for the 40-meter short beam. The boom consists of two pieces of standard 1-1/4 inch dia Do-It-Yourself aluminum tubing.

na spreaders are utilized as forms for the spirally wound elements. The 40-meter beam illustrated in Figs. 10-16 – 10-18, incl., is only 0.28 percent of full size. The elements measure 18 feet, tip to tip, and the boom is 16 feet in length. The feed-point impedance is approximately 12 ohms, thereby permitting the use of a 4:1 broad-band balun transformer to match the antenna to a 50-ohm coaxial feed line.

This antenna can be built for any 50-kHz segment of the 40-meter band and will operate with an SWR of less than 2.5:1 across that range. An SWR of 1 can be obtained at the center of the 50-kHz range to which the beam is adjusted, and a gradual rise in SWR will occur as the frequency of operation is changed toward the plus or minus 25-kHz points from center frequency.

Ten-inch-long stubs of aluminum welding rod or No. 8 aluminum clothesline wire are used at the tips of each element to help lower the  $Q$  (in the interest of increased bandwidth). The stubs are useful in trimming the elements to resonance after the beam is elevated to its final height above ground. Coarse adjustment of the elements is effected by means of tapped inductors located at the center of each element. Plastic refrigerator

boxes are mounted at the center of each element to protect the loading inductors and balun transformer from the effects of weather. Two coats of exterior spar varnish should be applied to the helically wound elements after they are adjusted to resonance. This will keep the turns in place and offer protection against moisture. Details for a 40-meter version of this style antenna are given here, but the same approach can be used in fabricating short beams for the other hf bands. Performance with the test model was excellent. The antenna was mounted 36 feet above ground (rotatable) on a steel tower. Many European stations were worked nightly on 40-meter cw. While using 100 watts rf output power with this antenna, reports from Europe ranged between RST 559 and RST 589. Similar good results were obtained when working South American stations and U.S. amateurs on the West Coast. All tests were conducted from Newington, Conn.

#### Construction Details

The construction of the 40-meter beam is very simple and requires no special tools or hardware. Two fiber-glass 15-meter quad arm spreaders are

mounted on an aluminum plate with U bolts, as shown in Fig. 10-17. A wooden dowel is inserted approximately six inches into the end of each fiber-glass arm to prevent the U bolts from crushing the poles. The aluminum mounting plate is equipped with U-bolt hardware for attachment to the 1-1/4-inch diameter boom.

A plastic refrigerator box is mounted on each element support plate and is used to house a Miniductor coil. No. 14 copper wire is used for the elements. The wire is wound directly onto the fiber-glass poles at a density of 40 turns per foot (not turns per inch) for a total of 360 evenly spaced turns. The wire is attached at each end with an automotive hose clamp of the proper size to fit the fiber-glass spreader. Since the fiber-glass is tapered, care must be taken to keep the turns from sliding in the direction of the end tips. Several pieces of plastic electrical tape were wrapped around the pole and wire at intervals of about every foot. All of the element half sections are identical in terms of wire and pitch. Coil dimensions and type are given in Figs. 10-17 and 10-18.

The driven-element matching system consists of a 4:1 balun transformer and a tightly coupled link to the main-element Miniductor. Complete details are given in Fig. 10-18.

Mounted at the end of each element held in place by the hose clamp is a short section of stiff wire material used for final tuning of the system. Since the overall antenna is very small in relation to a full-sized array, the SWR points of 2:1 are rather close to each other. The antenna shown in the photograph provides an SWR of less than 2:1 within about 30 kHz either side of resonance. This particular antenna was tuned for 7.040 MHz and can be used throughout the cw portion of the band. Tuning the antenna for phone-band operation should not be difficult and the procedure outlined below should be suitable.

Tuning

The parasitic element was adjusted to be about four percent lower in frequency than the driven element. A grid-dip oscillator was coupled to the center loading coil and the stiff-wire element tips were trimmed (a quarter of an inch at a time) until resonance was indicated at 6.61 MHz. For phone-band use, the ends could be snipped for 6.91 MHz. Adjusting the driven element is simple. Place an SWR meter or power meter at the input connector and cut the end wires (or add some if necessary) to obtain the best match between the line and the antenna.

SHORT HELICALLY WOUND VERTICAL ANTENNAS

The concept of size reduction can be applied to vertical antennas as well as to Yagi beams. One has the option of using lumped L and C to achieve resonance in a shortened system, or the antenna can be helically wound to provide a linear distribution of the required inductance, as shown in Fig. 10-19. No capacitance other than the amount existing between the radiator and ground is used in establishing resonance at the operating frequency. Shortened quarter-wavelength vertical antennas can be made by forming a helix on a long cylindrical form of reasonable dielectric constant. The diameter of the helix must be very small in terms of wavelength in order to prevent the antenna from radiating in the axial mode. Acceptable form diameters for hf-band operation are from one inch (2.5 cm) to 10 inches (25 cm) when considering the practical aspects of antenna construction. Insulating poles of fiber glass, PVC tubing, treated bamboo or wood, or phenolic are suitable for use in building helically wound radiators. If wood or bamboo is used the builder should treat the

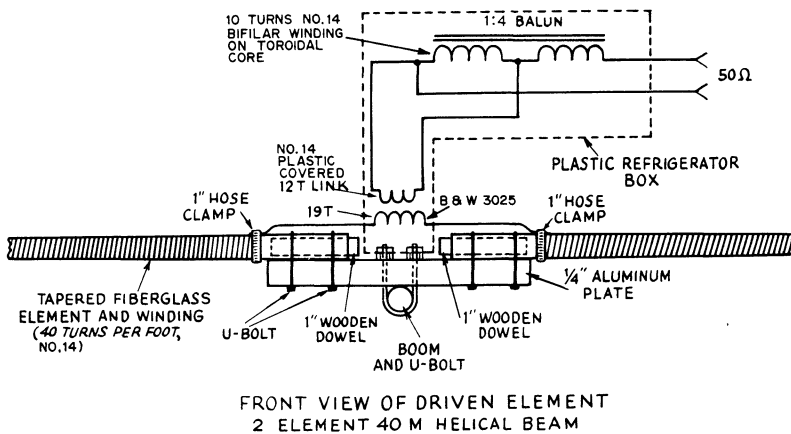

Fig. 10-18 — Schematic diagram of the balun assembly mounted inside the plastic utility box. The core is a single T-200-2 Amidon. The 12-turn link is wound directly over the 19-turn Miniductor.

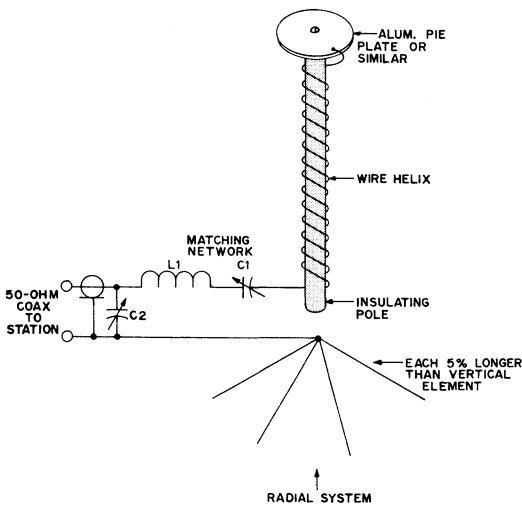

Fig. 10-19 — Details on how to build and hook up a helically wound short vertical antenna.

material with at least two coats of exterior spar varnish prior to winding the antenna element. The completed structure should be given two more coats of varnish, regardless of the material used for the coil form. Application of the varnish will weatherproof the antenna and prevent the coil turns from changing position.

No strict rule has been established concerning how short a helically wound vertical can be before a significant drop in performance is experienced. As a general recommendation, one should use the greatest amount of length consistent with available space. A guideline might be to maintain an element length of .05 wavelength or more for antennas which are electrically a quarter wavelength long. Thus, use 13 feet (4 meters) or more of stock for an 80-meter antenna, 7 feet (2 meters) for 40 meters, and so on.

A quarter-wavelength helically wound vertical can be used in the same manner as a full-size vertical. That is to say, it can be worked against an above-ground wire-radial system (four or more radials), or it can be used in a ground-mounted manner where the radials are buried or lying on the ground. Some operators have reported good results when using antennas of this kind which employed four helically wound radials which are cut for resonance at or slightly lower than the operating frequency. The latter technique should capture the attention of those persons who must utilize indoor antennas.

### Winding Information

There is no hard-and-fast formula for determining the amount of wire needed to establish resonance in a helical antenna. Experience has indicated that a section of wire approximately one

half wavelength long, wound on the insulating form with a linear pitch (equal spacing between turns) will come close to yielding a resonant quarter wavelength. Therefore, an antenna for use on 160 meters would require approximately 260 feet of wire, spirally wound on the support. No specific rule exists concerning the size or type of wire one should use in making a helix. It is reasonable to assume that the larger wire sizes are preferable in the interest of minimizing  $I^2R$  losses in the system. For power levels up to 1000 watts it is wise to use a wire size of No. 16 or greater. Aluminum clothesline wire is suitable for use in systems where the spacing between turns is greater than one wire diameter. Antennas requiring close-spaced turns can be made from enameled magnet wire or No. 14 vinyl-jacketed, single-conductor house wiring stock.

A short rod or metal disk should be made for the top or high-impedance end of the vertical. This is a necessary part of the installation to assure reduction in antenna  $Q$ . This broadens the bandwidth of the system and helps prevent extremely high amounts of rf voltage from appearing at the far end of the radiator. (Some helical antennas have acted like Tesla coils when used with high-power transmitters, and have actually caught fire at the high-impedance end when a stub or disk was not used.) Since the  $Q$ -lowering device exhibits some additional capacitance in the system, it must be in place before the antenna is tuned.

### Tuning and Matching

Once the element is wound it should be mounted where it will be used, with the ground system installed. The feed end of the radiator can be connected temporarily to the ground system. Use a grid-dip meter and check the antenna for resonance by coupling the dipper to the last few turns near the ground end of the radiator. Add or remove turns until the vertical is resonant at the desired operating frequency.

It is impossible to predict the absolute value of feed impedance for a helically wound vertical. The value will depend upon the length and diameter of the element, the ground system used with the antenna, and the size of the disk or stub atop the radiator. Generally speaking, the radiation resistance will be very low — approximately 3 to 10 ohms. An  $L$  network of the kind shown in Fig. 10-20 can be used to increase the impedance to 50 ohms. Constants are given for 40-meter operation at 7.0 MHz. The  $Q_L$  (loaded  $Q$ ) of the network inductors is low to provide reasonable bandwidth, consistent with the bandwidth of the antenna. Network values for other operating bands and frequencies can be determined by using the reactance values listed below. The design center for the network is based on a radiation resistance of 5 ohms. If the exact feed impedance is known the following equations can be used to determine precise component values for the matching network:

$$X_{C1} = QR_L$$

$$X_{C2} = 50 \sqrt{\frac{R_L}{50 - R_L}}$$

$$X_{L1} = X_{C1} + \left(\frac{R_L 50}{X_{C2}}\right)$$

where  $X_{C1}$  = Capacitive reactance of C1

$X_{C2}$  = Capacitive reactance of C2

$X_{L1}$  = Inductive reactance of L1

$Q$  = Loaded  $Q$  of network

$R_L$  = Radiation resistance of antenna

Example: Find the network constants for a helical antenna whose feed impedance is 5 ohms at 7 MHz,  $Q=3$ :

$$X_{C1} = 3 \times 5 = 15 \text{ and}$$

$$X_{C2} = 50 \sqrt{\frac{5}{50 - 5}} = 50 \sqrt{0.111} = 50 \times 0.333$$

$$= 16.666 \text{ and}$$

$$X_{L1} = 15 + \left(\frac{250}{16.66}\right) = 15 + 15 = 30$$

Therefore, C1 = 1500 pF, C2 = 1350 pF, and L1 = 0.7  $\mu$ H. The capacitors can be made from parallel or series combinations of transmitting micas. L1 can be a few turns of large Miniductor stock. At rf power levels of 100 W or less, large compression trimmers can be used at C1 and C2 because the maximum rms voltage at 100 W (across 50 ohms) will be 50. At, say, 800 W there will be approximately 220 volts rms developed across 50 ohms. This suggests the use of small transmitting variables at C1 and C2, possibly paralleled with fixed values of capacitance to constitute the required amount of capacitance for the network. By making some part of the network variable it will be possible to adjust the circuit for an SWR of 1 without knowing precisely what the antenna feed impedance is.

Fig. 10-19 illustrates the practical form a typical helically wound ground-plane vertical might take. Performance from this type antenna is

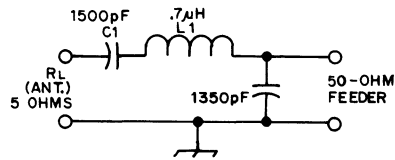

Fig. 10-20 - An L network suitable for matching the low feed impedance of helically wound verticals to a 50-ohm coaxial cable. The loaded  $Q$  of this network is 3.

comparable to that of many full-size quarter-wavelength vertical antennas. The major design trade-off is in usable bandwidth. All shortened antennas of this variety are narrow-band devices. At 7 MHz, in the example illustrated here, the bandwidth between the 2:1 SWR points will be on the order of 50 kHz, half that amount on 80 meters, and twice that amount on 20 meters. Therefore, the antenna should be adjusted for operation in the center of the frequency spread of interest.

### Bibliography

Source material and more extended discussion of topics covered in this chapter can be found in the references given below.

Dome, "Increased Radiating Efficiency for Short Antennas," *QST*, September, 1934.  
 Dome, "A Study of the DDRR Antenna," *QST*, July, 1972.  
 English, "A 40-Meter DDRR Antenna," *QST*, December, 1971.  
 King and Harrison, "The Impedance of Short, Long, and Capacitively Loaded Antennas with a Critical Discussion of the Antenna Problem," *Journal of Applied Physics*, Vol. 15, February, 1944.  
 Myers and DeMaw, "The HW-40 Micro Beam," *QST*, February, 1974.  
 Myers and Greene, "A Bite Size Beam," *QST*, September, 1973.  
 Sevick, "The Ground-Image Vertical Antenna," *QST*, July, 1971.  
 Sevick, "The W2FMI Ground-Mounted Short Vertical," *QST*, March, 1973.  
 Sevick, "The Constant-Impedance Trap Vertical" *QST*, March, 1974.

# VHF and UHF Antenna Systems

While the basic principles of antenna design are essentially the same for all communication frequencies, certain factors peculiar to vhf and uhf work call for changes in amateur antenna technique for the frequencies above 50 megahertz. Here the physical size of multielement arrays is reduced to the point where an antenna system having some gain over a simple dipole is possible in almost every location, and the more progressive stations may employ arrays having much higher gain than is possible on lower frequencies.

The importance of high-gain antennas in vhf work cannot be overemphasized. The reliable working range of a station operating on 144 MHz, for instance, may be only 30 miles or so when a simple dipole antenna is used, yet this same fellow may increase his working radius to 100 miles or more by the installation of a high-gain array. The directive system introduces other advantages also. By restricting the field covered at any one position the beam antenna helps to reduce pickup of man-made noises, and it may be instrumental in correcting interference to broadcast and television reception, by permitting communication in directions not coinciding with nearby antennas used on receivers for these services. A good antenna system often makes the difference between routine operating and outstanding success in the vhf field, and it is safe to say that by no other means can so large a return be obtained from a small investment as results from the erection of a high-gain antenna system.

## Design Considerations

Antenna systems for the vhf range are usually called upon to work over a wider frequency range than those used on lower bands; thus, antenna bandwidth becomes an important consideration in the design of a vhf array. It may be necessary, in some instances, to include this characteristic at the expense of other attributes which might be considered desirable, such as highest gain or front-to-back ratio.

A properly matched line is of utmost importance in the proper functioning of the vhf antenna system, because even with perfect matching the loss in a given line is essentially proportional to frequency (see Chapter Three). At 144 MHz, for example, the loss in a perfectly matched line is approximately five times what it is in the same

length of the same type of line at 28 MHz. Thus it may be more effective to use a high-gain array at relatively low height, rather than a simpler array at great height above ground, particularly if the antenna location is not shielded by buildings or heavy foliage in the immediate vicinity.

Height above ground is helpful, especially in cases where added height increases the distance to the visible horizon appreciably, but great height is by no means so all-important as it was once thought to be. Outstanding results have been obtained, particularly on 50 MHz, with relatively low antennas, and many 144-MHz stations are working out successfully with arrays not more than 25 to 40 feet above ground.

The effectiveness of a vhf antenna system can be increased markedly by stacking half-wave elements one above the other and feeding them in phase. Such stacking helps to lower the radiation angle, an important factor in extending vhf coverage, without changing the beamwidth in azimuth. Several examples of stacked arrays are shown in the following pages.

The physical size of a vhf array is an important factor in its performance. In receiving, the larger the area presented to an incoming signal the greater the strength of the signal at the receiver input terminals, other factors being equal. Thus an array for 432 MHz must be the same *size* as one for 144 MHz, if an equal signal is to be received on both bands. The array for the higher frequency will require three times as many elements as the one for the lower band, if similar element configurations are used in both.

## Polarization

Experience has shown that there is usually no marked difference in effective working radius with either horizontal or vertical polarization, though there are indications that horizontal may give somewhat higher signal levels over irregular terrain. The signal-to-noise ratio with horizontal systems is likely to be better, in regions where man-made noise is a serious problem. Horizontal arrays also may have some mechanical advantages. It is generally easier to build and rotate horizontal systems, particularly on the lower vhf bands. Simple 2-, 3- or 4-element arrays have proven very effective in 50-MHz work, and their use has reached the point



of standardization on horizontal systems for that band.

The picture is somewhat different on 144 MHz and higher bands. Vertical arrays are more easily constructed for these frequencies. Hundreds of mobile stations on 144 MHz, nearly all using vertical whip antennas, usually enjoy somewhat wider coverage when the fixed stations also use vertical antennas, though the loss from cross-polarization may not be important in hilly terrain. Where the 144-MHz band is used for emergency communication, a logical antenna setup consists of some sort of stacked (but nondirectional) collinear vertical array for the control station, and vertical whips for the portables and mobiles. Television and fm reception, both sensitive to interference from vhf stations, use horizontal antennas, and it can be shown that interference is more troublesome when the amateur stations also use horizontal systems.

Horizontal polarization is gaining ground in amateur vhf work, however, and it appears that in most areas its advantages outweigh the adverse factors. Except for emergency net operation, much of the normal 144-MHz operation is done with horizontal antennas today. Areas on both coasts still make use of vertical, however, and anyone starting in on the vhf bands should determine which polarization is in use in his locality before investing heavily in antenna installations. There is considerable polarization shift over mountainous or irregular terrain, but generally speaking, best results will be obtained when the same polarization is used at both ends of a path.

**ELEMENT LENGTHS AND SPACINGS**

The resonant length of an ungrounded antenna or antenna element is somewhat shorter than a half wavelength for the frequency at which it is to be used, as explained in Chapter Two. In dealing with vhf antennas it is convenient to measure the length in inches. The following formula gives the resonant length of a half-wave element:

$$\text{Length (inches)} = \frac{5904 \times K}{\text{Freq. (MHz)}}$$

where the factor *K* is dependent on the thickness of the antenna conductor and the frequency at which it is used. This factor is plotted in Fig. 2-4, Chapter Two, and applies to cylindrical conductors having uniform diameter throughout their length.

The length of a free-space half wavelength, together with lengths as modified by the factor *K* when it has the values 0.98, 0.96, and 0.94, are shown graphically for the 50-, 144-, 220-, and 420-MHz bands in Fig. 11-1. Element spacings are based on free-space lengths, which can readily be converted from the half-wavelength values shown in the charts.

The factor *K* as given in Fig. 2-4 is based on theoretical considerations which necessarily do not provide for different methods of mounting or support for the element. The exact resonant length depends to some extent on constructional features of this nature. In average cases, the following

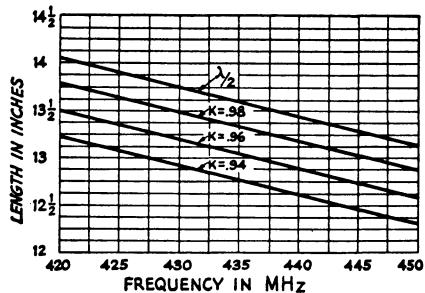
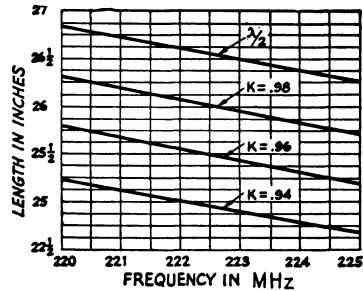
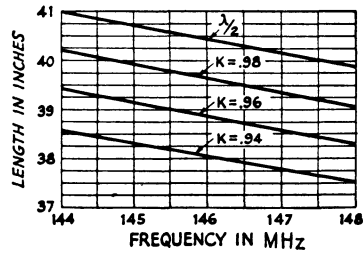
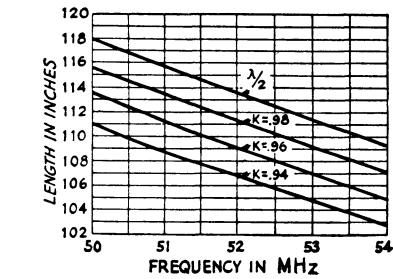

Fig. 11-1 — Frequency vs. length in inches for the 50-, 144-, 220- and 420-MHz bands, for a free-space half wavelength and resonant antenna lengths for various element length/thickness ratios (see Chapter Two). Lengths for values of *K* other than those given can be found by linear interpolation, e.g., the curve for *K* = 0.97 lies midway between the curves for *K* = 0.96 and 0.98, etc. To find the free-space wavelength used in calculating spacings multiply the length given for λ/2 by 2.

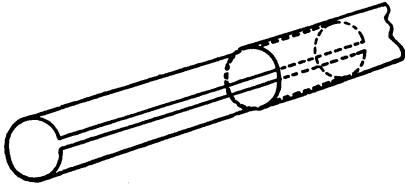

Fig. 11-2 — A simple method of providing for adjustment of element lengths. The insert is made of the same size tubing as the element, but is slotted and compressed to permit insertion into the ends of the elements.

formula has been found to work out well in practice:

$$\text{Length (inches)} = \frac{5540}{\text{Freq. (MHz)}}$$

This corresponds closely to the curves for  $K = 0.94$  in Fig. 11-1.

Tapered elements, in which successively smaller sizes of tubing are used either for light construction or in a collapsible element for portable use, tend to exhibit  $K$  factors associated with the smallest diameter of the taper. The exact resonant length also depends on how the element is mounted; an element that is supported at its center through a boom of appreciably larger diameter than that of the element, for example, will have a slightly different resonant length than one that is insulated from its support.

**Driven Elements**

The length of a driven element, whether the element is a simple half-wave dipole or is the fed element in a parasitic array, is not especially critical, since slight mistuning can easily be compensated for in the adjustment of the matching system used between the element and the transmission line. However, it is generally desirable that the element length be close to resonance at the median operating frequency. The graphs of Fig. 11-1 are sufficiently accurate for this purpose.

**Parasitic Elements**

Optimum spacings for the elements of a Yagi array are discussed in the section on parasitic

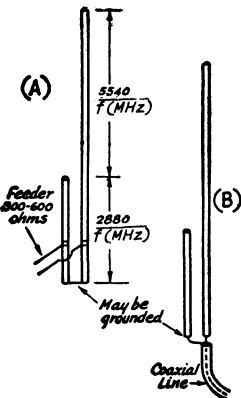

Fig. 11-3 — Two versions of the "J" antenna, used in mobile applications or in vertical arrays where parasitic elements are rotated around a fixed radiator.

arrays in Chapter Four. The optimum lengths for the parasitic reflector or director depend on the element spacings. The spacings are not highly critical, however, and the bandwidth is usually greater when the spacings of elements near the driven element are fairly large. Spacings of 0.2 wavelength (the half-wavelength figure given in Fig. 11-1 multiplied by 0.4) are customarily used in vhf antennas. With these spacings the reflector will be approximately 5% longer than the driven element and the first director will be about 5% shorter than the driven element. If additional directors are used they should be progressively shorter than the driven element, as illustrated by the practical arrays shown later in this chapter.

When the lengths of elements in an array are given in terms of a decimal part of a wavelength, the wavelength used as a reference is usually the free-space wavelength. The free-space wavelength is equal to the value given by the top curve in each graph in Fig. 11-1 multiplied by 2. When a "half wave" is referred to in connection with antennas, the resonant length usually is meant.

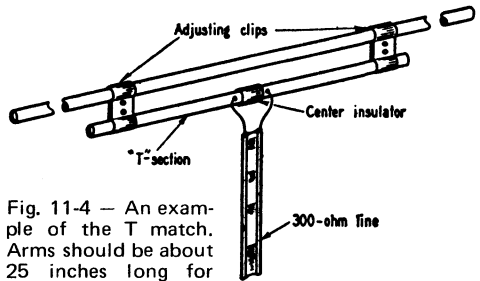

Fig. 11-4 — An example of the T match. Arms should be about 25 inches long for 50-MHz arrays.

**Adjustment of Element Length**

When an antenna design given in this chapter is to be duplicated it is necessary to do nothing more than to cut the elements to the lengths given. If the antenna is to be centered on a frequency in a different part of the band, it will be sufficient to scale all the lengths in proportion to the change in wavelength — that is, in inverse proportion to the ratio of the desired center frequency to that for which the antenna was originally designed.

For experimental work it is desirable to have some means for continuous adjustment of element length. Usually the required adjustment range will be not greater than 10% of the half wavelength, and in the case of tubing elements a device suitable for the purpose is shown in Fig. 11-2. It consists of a short length of tubing, usually of the same stock as the element, slotted lengthwise and compressed to make a tight fit in the element end.

**PHASING AND MATCHING SECTIONS**

Transmission-line lengths for such applications as phasing lines and Q sections can be determined from the formula

$$\text{Length (inches)} = \frac{5904 \times V}{\text{Freq. (MHz)}}$$

where  $V$  is the velocity factor of the type of line used. For open-wire lines separated by insulating spacers,  $V$  is approximately 0.975. Parallel-conductor lines of self-supporting tubing have a velocity factor close to unity. The velocity factors of various types of solid-dielectric lines, both parallel-conductor and coaxial, are given in Chapter Three.

**PRACTICAL ANTENNA DESIGNS**

The element lengths and spacings in the antennas described in this chapter have been worked out by experiment to meet practical operating requirements. Since these requirements often are conflicting, in terms of antenna design, compromises are necessary; for example, it is usually necessary to sacrifice a small amount of gain for the sake of reasonable bandwidth and a good front-to-back ratio. In general, this means that the element lengths and to a lesser extent the spacings (the latter are less critical than the element lengths) may not always conform to the values that investigation has shown to be optimum for maximum gain.

It can be emphasized, however, that a design that has been carefully worked out will, if accurately duplicated, give results identical with those obtained with the original antenna. If the builder has other objectives than the designer originally had, they may be achieved by individual adjustment; careful adjustment of lengths and spacings for a desired result, whether it be maximum gain, high front-to-back ratio, maximum bandwidth, or whatever, is a process that will have a great deal of appeal for the experimentally inclined amateur.

**TRANSMISSION LINES AND MATCHING METHODS**

As mentioned at the beginning of this chapter, it is important that the standing-wave ratio on the transmission line be kept as low as possible. Otherwise line losses may become prohibitive, particularly when solid-dielectric lines are used. Lines normally employed include open-wire lines of 300 to 600 ohms impedance, usually spaced 1/4 to 2 inches, polyethylene-insulated flexible parallel-conductor lines, available in 72-, 150- and 300-ohm impedances, and coaxial lines of 50 to 90 ohms.

Occasionally two coaxial lines are used side by side, with the inner conductors serving as the transmission line, and the outer conductors connected together and grounded. Such a line has twice the impedance of its individual components.

The various types of transmission lines can be matched to antenna systems in a wide variety of ways, as described in Chapter Three. The more popular methods are described below.

**The "J"**

Used principally as a means of feeding a stationary vertical radiator, around which parasitic elements are rotated, the "J" consists of a half-

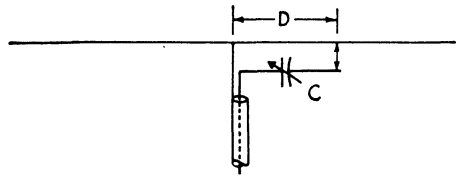

Fig. 11-5 — Schematic version of the gamma match. Values for  $C$  and  $D$  are given in the text.

wave vertical radiator fed by a quarter-wave stub matching section, as shown at A, Fig. 11-3. The spacing between the two sides of the matching section should be two inches or less, and the point of attachment of the line will depend on the impedance of the line used. The feeder should be moved along the matching section until the point is found that gives the best operation. The bottom of the matching section may be grounded for lightning protection.

A variation of the "J" for use with coaxial-line feed is shown at B in Fig. 11-3.

The "J" is also useful in mobile applications, though a simple quarter-wave whip will usually suffice.

**The Delta or "Y" Match**

Probably the simplest arrangement for feeding a dipole or parasitic array is the delta, or "Y" match.

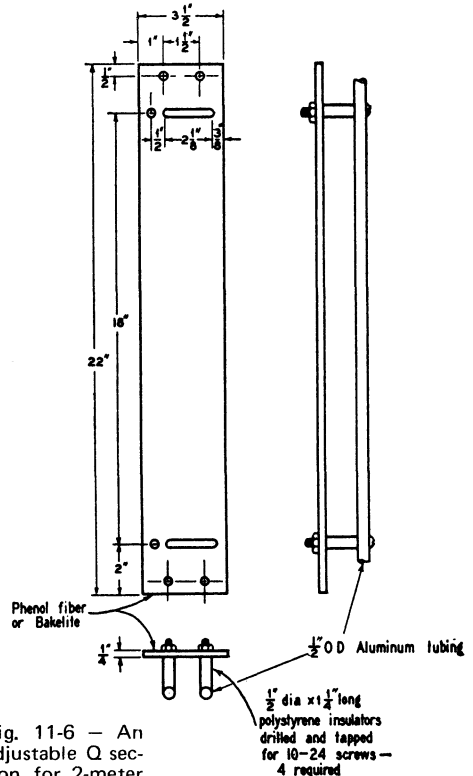

Fig. 11-6 — An adjustable Q section for 2-meter arrays.

Information on figuring the dimensions of the delta may be found in Chapter Three.

The chief weakness of the delta is the likelihood of radiation from the matching section, which may interfere with the effectiveness of a multielement array. It is also somewhat unstable mechanically, and quite critical in adjustment.

**The T Match**

The T match, shown in practical form in Fig. 11-4, provides a means of adjustment by sliding the clips along the parallel conductors, and its rigid construction is quite suitable for rotatable arrays. It may be used with a pair of coaxial lines of any impedance, or with the various other balanced transmission lines. The position of the clips should, of course, be adjusted for minimum standing-wave ratio (see Chapter Three). The T system is particularly well suited for use in all-metal "plumbing" arrays.

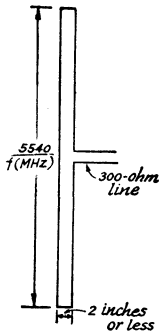

Fig. 11-7 — Details of a folded dipole for vhf use.

**The Gamma Match**

The gamma match, also described in Chapter Three, is well adapted to feeding all-metal arrays with coaxial line, as the outer conductor may be connected to the metal boom or to the center of the driven element. The inner conductor is tapped out from the middle of the driven element, usually through an adjustable clip. Construction can be similar to that shown for the T match.

Best operation results when a variable capacitor, *C* in Fig. 11-5, is included, to tune out the reactance of the matching section.

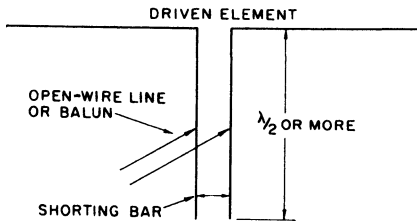

Fig. 11-8 — Combination tuning and matching stub for vhf arrays. The sliding shorting bar is used for tuning the driven element along with the stub itself. The transmission line (or balun, if coax line is used) is moved along the stub until the point at which the SWR is closest to unity is found.

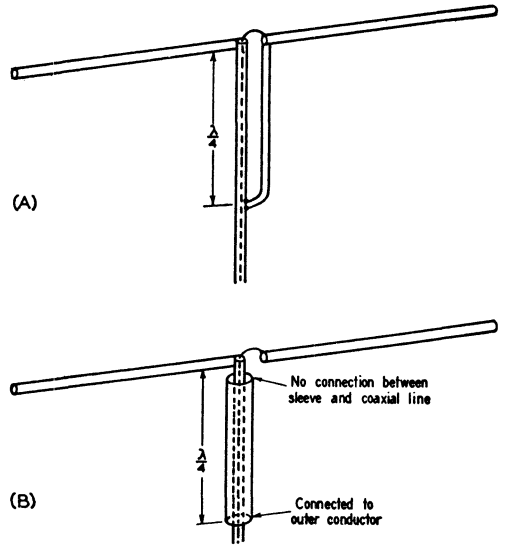

Fig. 11-9 — A "bazooka" line balancer is used to feed a balanced center-fed dipole with a coaxial line. In A it takes the form of a quarter-wave section of tubing the same size as the coaxial line. In B it is a metal sleeve connected to the outer conductor at the far end from the antenna.

and the point of connection on the driven element should be adjusted for minimum standing-wave ratio. The capacitance required will be under 75 pF for 50 MHz, or 25 pF for 144 MHz. The rf voltage at this point is low, so a receiving-type variable can be used for *C*. It should be provided with a weatherproof housing, which can be of metal, grounded to the boom of the array. The length of the matching section, *D*, will be about 10 inches for 50 MHz or 4 inches for 144 MHz.

**The Q Section**

As described in Chapter Three, a Q section can be used as an impedance transformer to match transmission lines to antenna systems of differing impedance. The matching section can be made of two pieces of wire, rod or tubing of suitable diameter, spaced to give the desired impedance. A table giving the impedance of lines of various dimensions may be found in Chapter Three.

Where the impedance that will be needed is not known, a Q section can be made with one of the members movable, as shown in Fig. 11-6. The spacing may then be adjusted for minimum standing-wave ratio on the transmission line.

Sections of coaxial line may be used for matching unbalanced lines to unbalanced loads, and some matching problems with balanced lines and loads can be solved with Q sections of Twin-Lead of suitable impedance. Where lines having other than air insulation are used as impedance transformers, their length should be reduced to take the propagation factor of the line into account. This will usually mean reductions to 66 and 82 percent of a full quarter wavelength, for

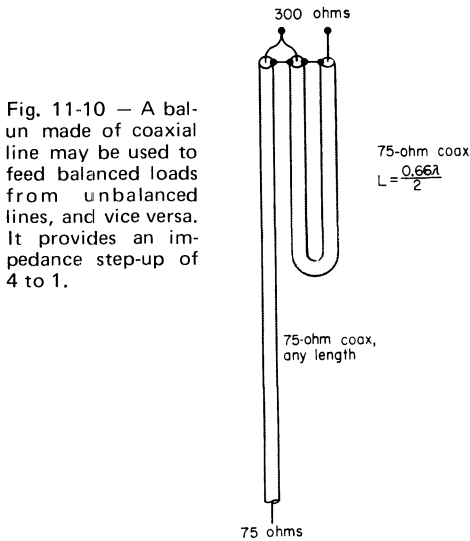

Fig. 11-10 — A balun made of coaxial line may be used to feed balanced loads from unbalanced lines, and vice versa. It provides an impedance step-up of 4 to 1.

polyethylene-insulated coaxial and parallel lines, respectively. The exact length for a matching section can be determined experimentally, if desired, by shorting one end of the line, coupling it to a calibrated grid-dip oscillator, and then trimming the line length until the grid-dip meter shows it to be resonant at the desired frequency.

**The Folded Dipole**

An effective means of matching various balanced lines to the wide range of antenna impedances encountered in vhf antenna work is the folded dipole (see Chapter Two), shown in its simplest form in Fig. 11-7. The simple folded dipole of Fig. 11-7 has a feed-point impedance of approximately 288 ohms. It may be fed with the popular 300-ohm line without appreciable mismatch.

The impedance at the feed point of a folded dipole may also be raised by making the diameter of the conductor used for the fed portion of the dipole smaller than the conductor used for the parallel section. Thus, in the 50-MHz array shown in Fig. 11-17, the relatively low center impedance is raised to a point where it may be fed directly with 300-ohm line by making the fed portion of the dipole of 1/4-inch tubing, and the parallel section of 1-inch. A 3-element array of similar dimensions could be matched by substituting 3/4-inch tubing in the unbroken section. Conductor ratios and spacings for other applications may be obtained from the folded-dipole nomogram in Chapter Two.

**Stub Matching**

The design and adjustment of the stub matching system shown in Fig. 11-8 are described in detail in Chapter Three. For experimental work the stub may be made of tubing and the connections to it made with sliding clips. In a permanent installation a stub of open-wire line, with all connections soldered, may be more satisfactory

mechanically. The transmission line may be open wire or Twin-Lead tapped directly on the stub. Coaxial line also may be used, but should be connected to the stub through a balun.

As described in Chapter Three, the adjustment procedure is one of varying the position of the line taps and the position of the shorting taps until the lowest possible SWR on the transmission line is obtained.

**USING COAXIAL LINES**

Flexible coaxial line has many desirable features. It is weatherproof, and may be buried underground or run inside a metal mast or tower without harmful effects. However, unless it is used properly, losses may be excessive, particularly on high frequencies when the line is more than a few wavelengths long. When coaxial line is used to feed a balanced load, as at the center of a driven element, some provision should be made for converting from the unbalanced line to the balanced load. Otherwise rf currents will flow on the outer conductor of the line, destroying its effectiveness.

One way of doing this is to install a detuning sleeve or “bazooka” at the point where the line connects to the driven element, as shown in Fig. 11-9. Both methods shown employ quarter-wave sections of line, shorted at the bottom end, presenting a high impedance to rf energy at the top end and preventing its flow along the outer conductor of the transmission line. The detuning section may be a piece of rod or tubing of a diameter similar to the coaxial line, as in Fig. 11-9A, or it can be a cylindrical sleeve, shorted to the outer conductor at the bottom, but insulated from it elsewhere, as in B. In either case, the length of the detuning element is a full quarter wave-

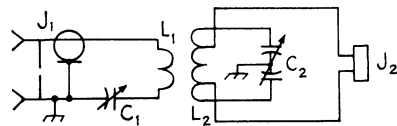

Fig. 11-11 — Matching circuit for coupling balanced to unbalanced lines.

C1 — 100-pF variable for 50 MHz, 50-pF for 144 MHz

C2 — 35-pF per-section split-stator variable, 0.07-inch spacing. Reduce to 4 stator and 4 rotor plates in each section in 144-MHz coupler for easier tuning; see text.

J1 — Coaxial fitting, chassis-mounting type.

J2 — Ceramic crystal socket.

L1 — 50 MHz: 4 turns No. 18 tinned, 1 inch diameter, 8 turns per inch. (B&W No. 3014.)

144 MHz: 2 turns No. 14 tinned, 1 inch diameter, 1/8-inch spacing. Slip over L2 before mounting.

L2 — 50 MHz: 7 turns No. 14 tinned, 1-1/2 inch diameter, 4 turns per inch. (B&W No. 3017.) Tap 1-1/2 turns from each end.

144-MHz: 5 turns No. 12 tinned, 1/2 inch diameter, 7/8 inch long. Tap 1-1/2 turns from each end.

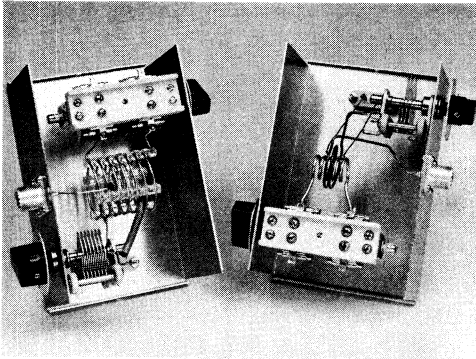

Fig. 11-12 — Practical construction of matching circuits of the type shown in Fig. 11-11, for 50 MHz, left, and 144 MHz, right. Each is built on one piece of a two-piece aluminum box. These views are of the inside of the top piece.

length; the propagation factor of the line does *not* enter into the picture here.

Another device for feeding balanced loads with coaxial line is called a “balun,” and may take several forms. These methods also provide a 4-to-1 impedance step-up at the balanced end. A balun may be simply a folded half wavelength of coaxial line, connected as shown in Fig. 11-10.

A third method is the use of an inductively coupled matching circuit, as shown in Fig. 11-11. The coupler may be at the transmitter, anywhere along the transmission line, or in the antenna assembly itself. It should be tuned for minimum standing-wave ratio on the coaxial line, and then the transmitter loading should be adjusted to the desired value.

Practical couplers of this type are shown in Fig. 11-12, one designed for 50 MHz and the other for 144 MHz. With the taps on L2 placed as specified in Fig. 11-11 these circuits will match balanced loads in the range 100-1600 ohms to a coaxial line (50 or 75 ohms) and so are suitable for use with 300- to 450-ohm parallel-conductor lines even when these lines are operating at a moderately high standing-wave ratio. If a 75-ohm balanced line is connected at J2 the taps should be moved toward the center of L2.

## ANTENNA SYSTEMS FOR 50 AND 144 MHZ

A simple dipole may be used on 50 and 144 MHz if a more pretentious antenna cannot be installed, but it is highly recommended that some form of directional array be used. While any of the designs that follow can be adapted to either band, practical considerations usually call for the use of Yagi-type arrays on 50 MHz. Yagi configurations are also employed on higher frequencies, but the small size of the elements needed for 144 MHz and higher makes it practical to use collinear arrays, stacked Yagis, corner-reflector arrays and other more complex systems on these bands.

As shown in Fig. 11-12, the couplers are housed in aluminum utility boxes, complete shielding being desirable. These boxes are 3 by 4 by 6 inches (76 × 102 × 152 mm), and are the two-piece variety. All the components are mounted on one of the pieces. With only slight modification a standard chassis could be used, the shielding being completed by adding a bottom cover.

The two units use similar components. The main tuning capacitor, C2, is fastened to the front wall 1-1/4 inches (32 mm) from the left side. The series capacitor, C1, and the coaxial fitting, J1, are 1-1/8 inches (29 mm) up from the bottom of the rear wall and 1-1/8 and 2-3/4 inches (70 mm), respectively, from the left edge, viewing from the back. A ceramic crystal socket, J2, is the terminal for the balanced line. It is mounted on top, one inch (25 mm) from the edge.

The 50-MHz coils are cut from commercially available stock inductors. The coupling winding, L1, is inserted inside the tapped coil. The plastic strips on which the coils are wound keep the two coils from shorting to each other, so no mechanical support other than that provided by the leads is needed. The leads to L1 are brought out between the turns of L2, and are insulated from them by two sleeves of spaghetti, one inside the other. Do not use the soft vinyl type of sleeving, as it will melt too readily if, through an accident to the antenna system, either coil should run warm. In the 144-MHz unit the method of assembling of the coils is reversed, the tuned circuit coil, L2, being inside the coupling coil.

The components used are adequate for fairly high power. Similar tuning capacitors are used in both couplers, but some of the plates are removed from the one in the 144-MHz unit. This provides easier tuning, but the capacitor may be left in its original condition if desired.

The method of adjusting this type of matching circuit is covered in Chapter Three. Use of an SWR indicator is highly recommended, since the proper settings of C1 and C2 will be those that result in the lowest possible SWR in the coax line between the transmitter and the matching circuit.

Loading on the transmitter final amplifier should be adjusted at the transmitter, *after* the SWR in the coax line has been brought as close as possible to 1 to 1.

### YAGI ARRAYS FOR 50 MHZ

A Yagi array is favored by many amateurs for vhf use because it offers high gain per element and its mechanical assembly is simple. Vhf Yagi arrays usually employ wide spacing of the elements; 0.15 wavelength or more for the reflector and 0.2 wavelength or more for the directors are commonly used. Closer spacings than these tend to make the array tune too sharply to be useful across an appreciable portion of a vhf band. Lack of sufficiently broad frequency response, even with

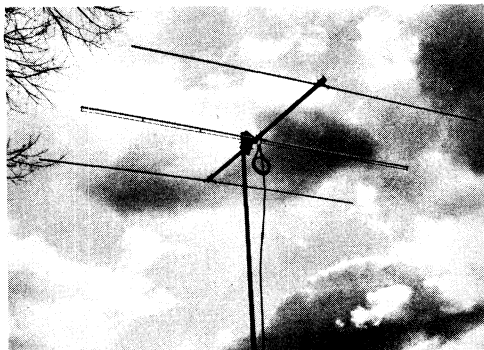

Fig. 11-13 — Lightweight 3-element 50-MHz array. Feeder is 52-ohm coax, with a balun for connection to the folded-dipole driven element. Balun may be coiled, as shown, or taped to supporting pipe. Dimensions are given in Fig. 11-14.

wide spacing, is a problem in nearly all antenna designs for 50 MHz.

### 3-Element Lightweight Array

The 3-element 50-MHz array of Fig. 11-13 weighs only 5 pounds. It uses the closest spacing that is practical for vhf applications, in order to make an antenna that could be used individually or stacked in pairs without requiring a cumbersome support. The elements are half-inch aluminum tubing of 1/16-inch wall thickness, attached to the 1-1/4-inch dural boom with aluminum castings made for the purpose. By limiting the element spacing to 0.15 wavelength the boom is only 6 feet long. Two booms for a stacked array can thus be cut from a single 12-foot length of tubing.

The folded-dipole driven element has No. 12 wire for the fed portion. The wire is mounted on 3/4-inch cone standoff insulators and joined to the outer ends of the main portion by means of metal pillars and 6-32 screws and nuts. When the two halves are pulled up tightly and wrapped around

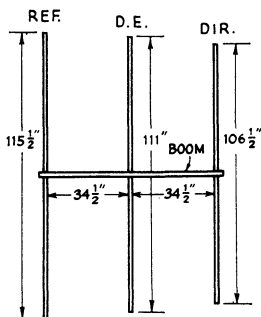

Fig. 11-14 — Dimensions of the 3-element antenna shown in Fig. 11-13, for working in low-frequency section of the 50-MHz band. The elements are 1/2-inch aluminum tubing. The driven element in Fig. 11-13 is a folded dipole using No. 12 wire for fed section, as described in the text.

the screw, solder should be sweated over the nuts and screw ends as protection against weather corrosion. The same treatment should be used at each standoff. Mount a soldering lug on the ceramic cone, wrap the end of the lug around the wire, and solder the whole assembly together. These joints and other portions of the array may be sprayed with clear lacquer as an additional protection.

The inner ends of the fed section are 1-1/2 inches apart. Slip the dipole into its aluminum casting, and then drill through both element and casting with a No. 36 drill, and tap with 6-32 thread. Suitable inserts for mounting the standoffs can be made by cutting the heads off 6-32 screws. Taper the cut end of the screw slightly with a file and it will screw into the standoff readily.

Cut the dipole length according to Fig. 11-1 for the middle of the frequency range you expect to use most. The reflector and director will be approximately 4% longer and shorter, respectively. The closer spacing of the parasitic elements (0.15 wavelength) makes this deviation from the usual 5% desirable.

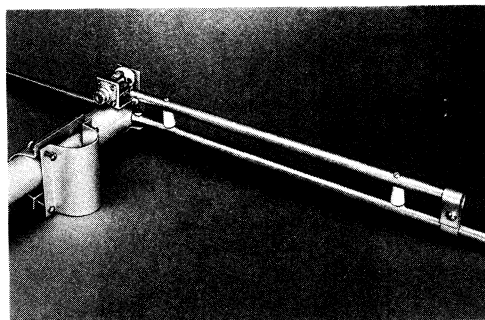

Fig. 11-15 — Typical gamma-match construction. The variable capacitor, 50 pF, should be mounted in an inverted plastic cup or other device to protect it from the weather. The gamma arm is about 12 inches long for 50 MHz, 5 inches for 144 MHz.

The folded dipole gives the single 3-element array a feed impedance of about 200 ohms at its resonant frequency. Thus it may be fed with a balun of the type shown in Fig. 11-10, using 52-ohm instead of 75-ohm coax. A gamma-matched dipole may also be used, suggested construction being as shown in Fig. 11-15. If the gamma match and 72-ohm coax are used, a balun will convert to 300-ohm balanced feed, if Twin-Lead or 300-ohm open-wire TV line feed is desired. If the dimensions are selected for optimum performance at 50.5 MHz the array will show good performance and a fairly low standing-wave ratio over the range from 50 to 51.5 MHz.

A closeup of a mounting method for this or any other array using a round boom is shown in Fig. 11-16. Four TV-type U bolts clamp the horizontal and vertical members together. The metal plate is about 6 inches square. If 1/4-inch sheet aluminum is available it may be used alone, though the photograph shows a sheet of 1/16-inch stock

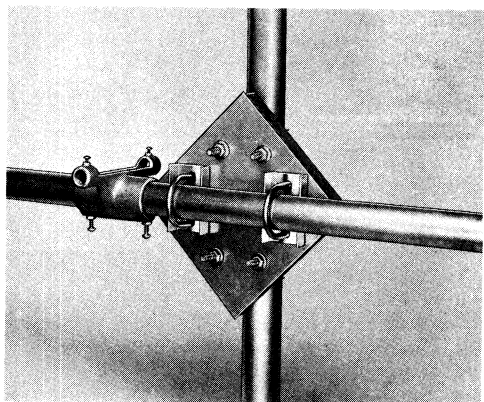

Fig. 11-16 — Closeup photograph of the boom mounting for the 3-element 50 MHz array. A sheet of aluminum 6 inches square is backed up by a piece of wood of the same size. TV-type U clamps hold the boom and vertical support together at right angles. At the left of the mounting assembly is one of the aluminum castings for holding the beam elements.

backed up by a piece of wood of the same size for stiffening. Tempered Masonite is preferable to wood, as it will stand up better in weather.

#### High-Performance 4-Element Array

The 4-element array of Fig. 11-17 was designed for maximum forward gain, and for direct feed with 300-ohm balanced transmission line. The parasitic elements may be any diameter from 1/2 to 1 inch, but the driven element should be made as shown in the sketch. The spacing between driven element and reflector, and between driven element and first director, is 0.2 wavelength. Between the first and second directors the spacing is 0.25 wavelength.

The same general arrangement may be used for a 3-element array, except that the solid portion of the dipole should be 3/4-inch tubing instead of 1 inch.

With the element lengths given the array will give nearly uniform response from 50 to 51.5 MHz, and usable gain to above 52 MHz.

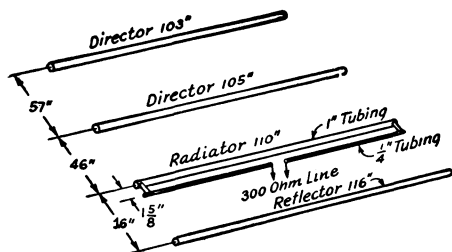

Fig. 11-17 — Dimensional drawing of the 4-element 50-MHz array. Element lengths and spacings were derived experimentally for maximum forward gain at 50.5 MHz.

If a shorter boom is desired, the reflector spacing can be reduced to 0.15 wavelength and both directors spaced 0.2 wavelength, with only a slight reduction in forward gain and bandwidth.

#### 5-Element 50-MHz Array

As aluminum or dural tubing is usually sold in 12-foot lengths this dimension imposes a practical limitation on the construction of a 50-MHz beam. A 5-element array that makes optimum use of a 12-foot boom may be built according to Fig. 11-18. If the aluminum casting method of mounting elements shown for the 3-element array is employed the weight of a 5-element beam can be held to under 10 pounds.

The gamma match and coaxial line are recommended for feeding such an array. If it is desired to use 300-ohm line because of its lower losses, the gamma can be driven through a section of 75-ohm line sufficiently long to provide for rotation of the antenna, and then can be converted to a balanced 300-ohm load at the anchor point by using a balun as shown in Fig. 11-10.

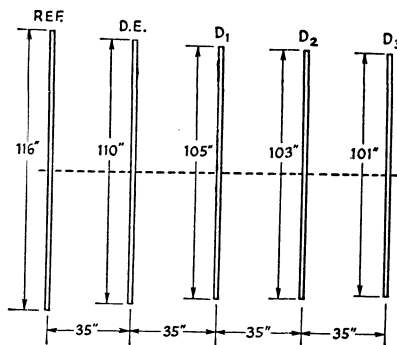

Fig. 11-18 — Five-element Yagi to fit on a 12-foot boom. Dimensions are centered at 51 MHz for working over the 50-52 MHz range.

Elements should be spaced approximately 0.15 wavelength, or about 35 inches. With 5 or more elements, good bandwidth can be secured by tapering the element lengths properly. With the dimensions given in Fig. 11-18 the antenna will work well over the first two megahertz of the band, provided that the SWR is adjusted for minimum at 51 MHz.

#### WIDE SPACED 6-ELEMENT YAGI

High gain can be obtained by extending the length of a Yagi array to about one wavelength as, discussed in Chapter Four. At 50 MHz an overall length of about two wavelengths, requiring a boom of the order of 20 feet long, is practicable constructionally. Fig. 11-19 shows a 6-element array of this type, and Fig. 11-20 gives the element dimensions and spacings for a center frequency of 50.6 MHz. The same element arrangement can be used for frequencies higher in the band by subtracting 2 inches from every dimension for each megahertz increase in center frequency. The band-



width for 2 to 1 SWR is approximately 1 megahertz.

The elements in the antenna shown in Fig. 11-19 are half-inch aluminum tubing, mounted on a 1-1/4-inch diameter dural boom by the use of castings of the type used in the 3-element array described earlier. If a boom of the requisite length cannot be obtained in one piece it can be made by splicing two or more pieces together, if suspension bracing such as is shown in Fig. 11-19 is used. The boom in this case was made from three pieces of tubing with a short length of the next smaller diameter tubing inside the joint. As the fit was loose, the joint was shimmed with flat strips of sheet aluminum. After assembly a few sheet-metal screws were used to make a tight joint. The element-mounting castings, if used, should be installed before these screws are put in place.

Joints in the boom cause no serious problem if the suspension shown is used to provide additional support. Steel wire can be substituted for the tubing that was incorporated in this antenna. Fig. 11-21 shows the method of fastening the tubing to the pipe mast. A comparable clamp can be used at the boom end of the brace.

Fig. 11-21 also shows an alternative method of mounting the elements on the boom. The clips should be formed so that when the bolt is tightened the element is pulled tight against the bottom edges of the holes in the boom. The boom of this antenna is fastened to the pipe mast by the method shown in Fig. 11-16, except that the plate was made long enough so that four U clamps could be used on the boom.

The 6-element antenna is fed with 52-ohm coax through the gamma match shown in Fig. 11-22. This uses a tubular capacitor of the type described in Chapter Nine. The outside tube is the same material as that used for the elements, and is supported from the driven element by ceramic standoff insulators one inch high. These are fastened to the tubing with clips made from sheet aluminum. The sliding arm is 1/4-inch rod insulated from the outer tube by polystyrene bushings. One of these is force-fitted on the sliding rod with its outer diameter such as to make a sliding fit inside the tube. The other bushing fits tightly inside the outer end of the tube and is drilled at the center so the sliding rod can move freely through it. The bushings can be made from polystyrene rod.

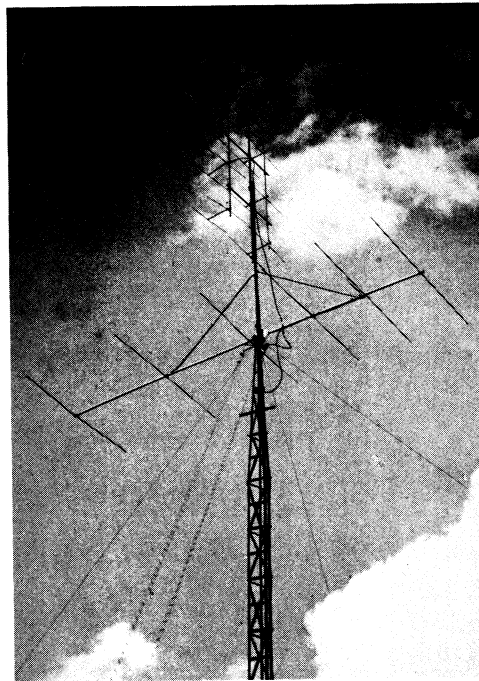

Fig. 11-19 — Six-element long Yagi for 50 MHz. Boom has two braces running diagonally to the mast, a method of construction that permits using tubing of relatively small diameter and obviates the necessity for a one-piece boom. (The antenna at the top is a 16-element broadside array for 144 MHz.)

The matching section should be adjusted by using a standing-wave-ratio meter, with the meter preferably at the antenna during the adjustment process. The antenna can be temporarily mounted eight or ten feet above ground while this adjustment is being made if the feed point is not accessible in the final location.

### A 5-OVER-5 STACKED ARRAY FOR 50 MHZ

Stacked 50-MHz arrays will show more than their theoretical improvement over single bays on some propagation paths, and less on others. The stacked system is likely to work well on most

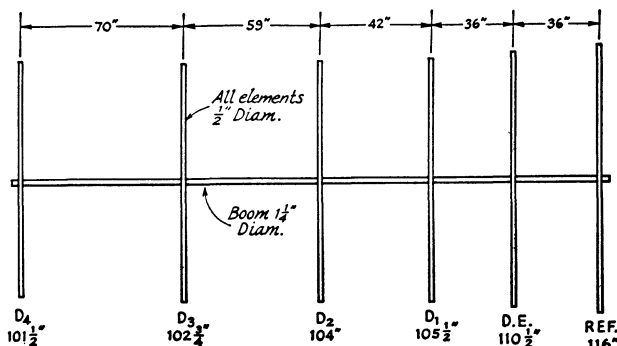

Fig. 11-20 — Dimension drawing of the 6-element 50-MHz antenna. The driven element is fed through a gamma matching section constructed as shown in Fig. 11-22.

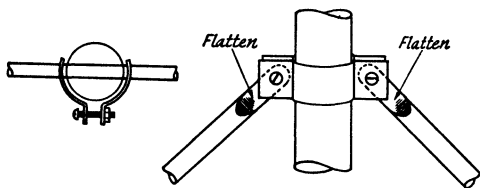

Fig. 11-21 — Method of mounting suspension braces to a pipe mast is shown at the right. The braces are flattened at the ends and bolted to semicircular clamps formed from aluminum sheet. A method of mounting elements on a boom is shown at the left. Elements go through holes drilled through the boom, and are held tight by the pull-down clamps as shown. The clamps can be made from sheet aluminum.

circuits, and is usually a very good investment for the DX-oriented 6-meter man.

The array consists of two 5-element Yagis stacked a half wavelength apart, and has been described by Edward Linde, WB2GXF. Element lengths and spacings are given in Fig. 11-24. With the phasing system used, the spacing could be increased to 12 feet for slightly more gain. The mechanical design is simple and readily duplicated. Principal details can be seen from the drawings and the photograph of the mock-up, Fig. 11-23, which shows how elements are mounted to the boom.

#### Mechanical Details

The folded-dipole driven elements allow some range of adjustment of the feed impedance of the system, through the use of small-dia fed portions whose spacing from the unbroken larger portion can be varied. The fed portions are 1/8-inch aluminum rod or hard-drawn wire, with the outer ends bent 90 degrees and threaded to permit fastening them in place with nuts, once the optimum spacing from the larger portion is found. The unbroken portion of the dipole is 1/2-inch (outside diameter) hard-drawn aluminum tubing, mounted to the boom by means of an aluminum plate and a U-clamp, as shown in the mock-up.

The fed portion is fastened to the lower side of the boom, using TV feed-line standoff insulators. Should it be impossible to find suitable insulators ready-made, the spacing between the large and small portions of the dipole can be maintained with blocks or pillars of insulating material. If rod or hard-drawn wire is used, it will be stiff enough to require little or no bracing. Softer wire may need several insulators mounted at intervals along the dipole. In bending the outer ends of the fed portions, take the bending slow and easy, and don't try to bend at a sharp angle. Hard stiff materials break easily.

The basic idea of the folded-dipole driven elements in this system is to develop approximately 400 ohms impedance in each bay, which is then fed with 93-ohm coax and a half-wave balun, as shown in Fig. 11-25. The impedance at the center of the phasing system thus becomes approximately 50 ohms, and can be fed directly with 50-ohm coaxial cable. Adjustment of the spacing,  $S$

in Fig. 11-25, gives some range of impedance variation. For the system shown, two inches center-to-center gave a good match to the 50-ohm main transmission line.

The phasing harness and baluns are made of RG-62A/U 93-ohm coax, each piece (4 required) having a shield length of 77-3/4 inches. The line and balun should be taped to the boom near to the driven element, to prevent flexing of the leads and the inevitable breakage that would otherwise result. The phasing lines are then run along the boom and the vertical support, to a coaxial T fitting at the midpoint, for connection to the main line. The phasing lines should be taped to the vertical support at frequent intervals. The spacing between bays, one-half wavelength, will be about 10 feet. Greater spacing, up to about 12 feet or 5/8 wavelength, will give somewhat more gain. If this can be handled mechanically, either of the phasing lines can be made an electrical half-wavelength longer (77-3/4 inches) and the bays will still be fed in phase.

#### Adjustment and Use

With the dimensions given, checking with an SWR indicator inserted between the coaxial T and the main line showed an SWR under 1.3 to 1 from 51.2 MHz to the low end. The best match, about 1.1 to 1, was in the most-used part of the band from 50.1 to 50.3 MHz. Such a test should preferably be made with the array in the position in which it is to be used. The best alternative is to prop up the array at ground level, with the booms pointing straight up. Varying the spacing between the fed and unbroken portions of the folded-dipole driven elements will provide a range of matching adjustment, if the SWR turns out to be higher than you like. The two bays should have the same spacing for each check, if this is done.

#### 144-MHz PARASITIC ARRAYS

The main features of the 50-MHz arrays previously described can be adapted to 144-MHz antennas, but the small physical size of arrays for this

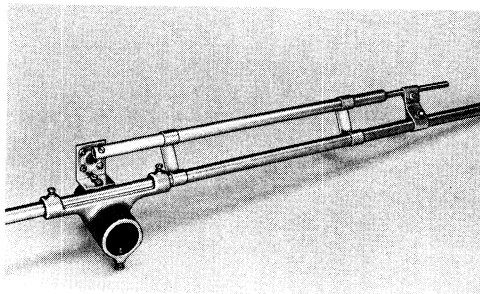

Fig. 11-22 — Gamma matching section using tubular capacitor. The sheet-aluminum clip at the right is moved along the driven element for matching. The small rod can be slid in and out of the 15-inch tube for adjustment of series capacitance. The rod should be about 14 inches long.

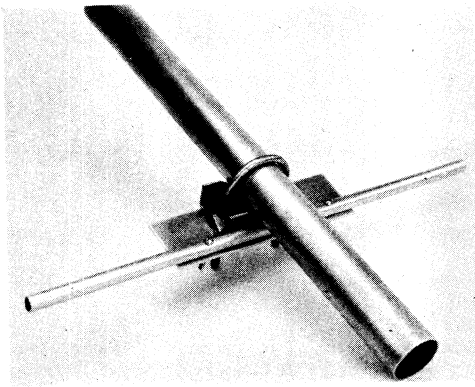

Fig. 11-23 — A model showing the method of mounting the elements in the 50-MHz array. An aluminum plate is shown, but suitable angle stock will provide an even stronger assembly. Elements are 1/2- or 3/8-inch hard-drawn aluminum tubing.

frequency makes it possible to use larger numbers of elements with ease. Few 2-meter antennas have less than 4 or 5 elements, and most stations use more, either in a single bay or in stacked systems.

**A 4-Element Array**

Parasitic arrays for 144 MHz can be made readily from TV antennas for Channels 4, 5, or 6. The relatively close spacing normally used in TV arrays makes it possible to approximate the recommended 0.2 wavelength at 144 MHz, though the element spacing is not a critical factor. A 4-element array for 144 MHz that can be made from a Channel 6 TV Yagi is shown in Fig. 11-26. It may be fed with a gamma match and 52-ohm coax, as shown. However, most TV antennas are designed for 300-ohm feed, and the same feed system can be employed for the 2-meter array that is made from them.

If one wishes to build his own Yagi antennas from available tubing sizes, the boom of a 2-meter antenna should be 3/4 to 1 inch aluminum or

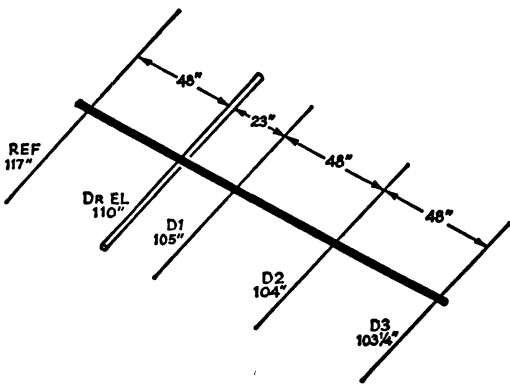

Fig. 11-24 — Element lengths and spacings for the WB2GXF 5-over-5 array for 50 MHz.

dural. Elements can be 1/4- to 1/2-inch stock. They can be fastened to the boom by the method shown in Fig. 11-21 if the relative diameters of elements and boom are such that the boom will not be unduly weakened by this construction. An alternative mounting method is shown in Fig. 11-30.

Recommended spacing for up to 6 elements is 0.2 wavelength, though this is not too critical. Gamma-match feed is recommended for coax, or a folded dipole and balun may be used. If balanced line is to be used the folded dipole is recommended, the 4 to 1 ratio of conductor sizes being about right for most designs.

**LONG YAGIS FOR 144 MHZ**

It becomes practicable, constructionally, at 144 MHz and higher frequencies to build Yagi antennas that are several wavelengths long, resulting in increased gain and directivity as described in Chapter Four. A representative design is shown in

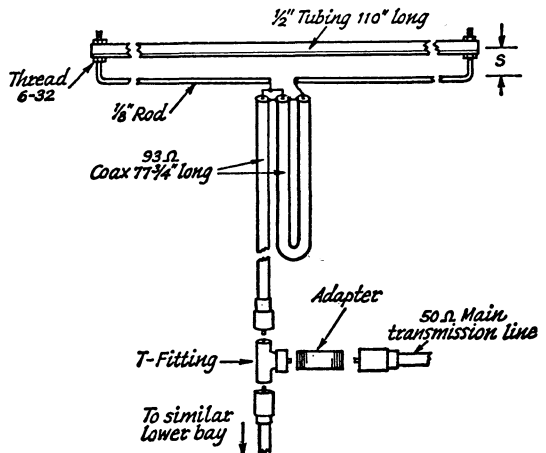

Fig. 11-25 — Details of the driven elements and phasing system used in the 50-MHz stacked array. The folded dipole is set up so that its feed impedance is approximately 400 ohms. Two half-wave baluns and half-wave phasing sections step down to about 100 ohms. The two bays thus connected in parallel may be fed with 50-ohm coax directly.

Fig. 11-27. It uses 13 elements — reflector, driven element, and eleven directors — with the director lengths following the third ( $D_3$ ) successively 1/4 inch shorter. The lengths given apply when the type of element mounting shown in Fig. 11-28 is used — i.e., the element is not mounted through the boom but is fastened to it on top — and when the elements are 3/32 inch in diameter. Steel rods were used as elements in the original model of this antenna. According to the designers, W2NLY and W6QKI, the element diameter should not exceed 1/8 inch.

The driven element (which need not be of the same construction as the reflector and directors) can be a folded dipole or can be fed by any of the

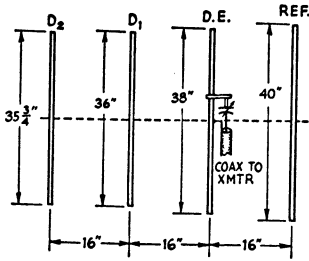

Fig. 11-26 — Four-element 144-MHz Yagi. Gamma matching is recommended, using a gamma section of similar construction to that shown in Fig. 11-15, with a gamma rod having a length of 6 inches. The series capacitor should be a 50-pF variable; receiver-type plate spacing is adequate for power levels up to a few hundred watts.

matching systems discussed earlier. The feed-point impedance with a simple dipole fed element is 15 to 20 ohms, about the same as in a 3-element Yagi of ordinary design.

The length of the antenna can be extended with some increase in gain (see Chapter Four) by adding similarly spaced directors, similarly tapered in length. It may also be made shorter, with reduced gain, by cutting off any desired section to the right of  $D_5$  in Fig. 11-27.

In terms of wavelengths, the optimum element spacings for an antenna of this type are slightly over 0.1 wavelength from driven element to first director and between the first, second and third directors, 0.2 wavelength from third to fourth director, and 0.4 wavelength between succeeding directors.

**COLLINEAR ARRAYS FOR 144 MHZ**

Excellent performance in antenna systems for 144 MHz and higher bands is obtainable through the use of curtains of 4, 6, 8 or more elements, arranged in pairs and fed in phase. Parasitic reflectors are usually mounted 0.15 to 0.25 wavelength in back of each driven element, though the driven elements alone may be used in a bidirectional array. Screen reflectors are also used with collinear elements. Such arrays may employ either horizontal or vertical polarization. Horizontal is shown in the examples.

The supporting structure may be either wood or metal. If the elements are mounted at their centers (the point of minimum rf voltage) no insulation need be used. It is desirable to keep the

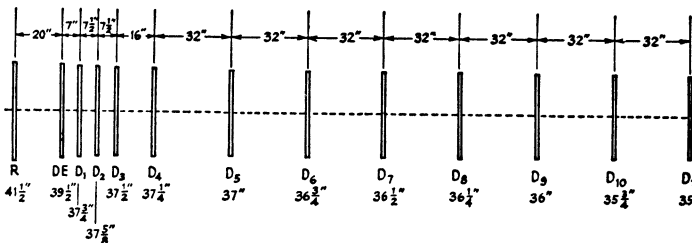

Fig. 11-27 — Thirteen-element long Yagi antenna for 144 MHz (W2NLY-W6QK1). Dimensions are for optimum performance in the 144-145-MHz segment of the band. For maximum performance in higher portions, decrease the element lengths 1/4 inch for each megahertz increase in frequency. Dimensions shown apply only for the type of parasitic element construction described in the text and shown in Fig. 11-28.

supporting members in back of the elements, particularly when all-metal construction is employed.

**A 12-Element Array**

Six half waves in phase, with parasitic reflectors, may be used as shown schematically in Fig. 11-29. The mechanical features of the 12-element array are shown in Figs. 11-30 and 11-31. The spacing of the reflectors in this array is made 0.15 wavelength, to bring down its feed impedance to the point where it can be fed with 300-ohm line without appreciable mismatch. Dimensions are given in the caption for Fig. 11-32.

**A 16-Element Array**

Designs similar to that given for the 12-element system may be used for eight half waves in phase, with reflectors, as shown in Fig. 11-33. (This

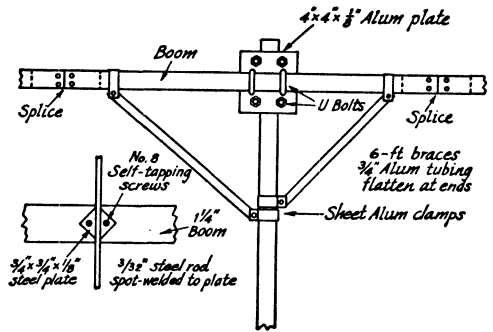

Fig. 11-28 — Boom support and element mounting used in the 13-element Yagi antenna of Fig. 11-27.

antenna is the uppermost one in Fig. 11-19.) Element dimensions are the same as for the 12-element array, given in the caption for Fig. 11-32.

The extra elements bring the feed impedance of this system down, so the reflector spacing is made 0.2 wavelength for the 16-element array. The impedance is usually slightly below 300 ohms for such an arrangement, though not low enough so that the efficiency is greatly affected. A 300-ohm

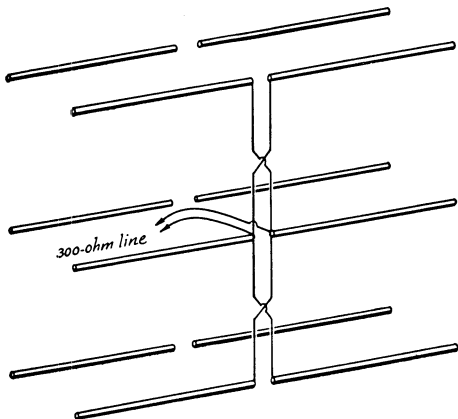

Fig. 11-29 — Element arrangement and feed system of the 12-element curtain array. Reflectors are spaced 0.15 wavelength behind the driven elements.

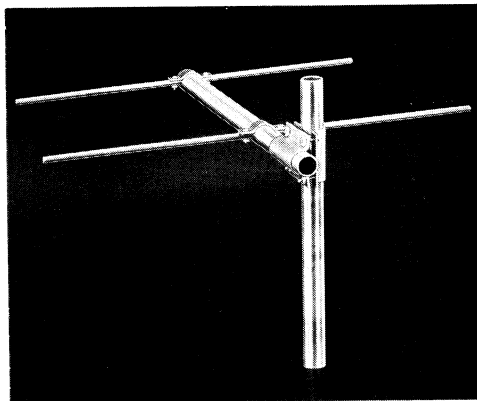

Fig. 11-30 — Model showing the method of assembly for all-metal construction of phased arrays. Dimensions of clamps are given in Fig. 11-31.

transmission line may be connected at the midpoint of the phasing line. However, the builder may wish to experiment with an adjustable Q section at the feed point to achieve a more precise match. One feed method that has been employed with the 16-element array is to use a quarter-wave Q section of 300-ohm Twin-Lead, and then make the main transmission line of open-wire line of 400 to 500 ohms impedance.

The Q section may also be any *odd* multiple of a quarter wavelength. This suggests the use of the flexible insulated Twin-Lead as the rotating portion of the transmission line, bringing it to an anchor point just below the array, where open-wire line may comprise the balance of the run. This method is used in the array shown in Fig. 11-19.

**Very Large Arrays**

Where more than 16 elements are used in a collinear array, the system is usually broken down into separate 12- or 16-element groups, and these are fed in phase. This is done to achieve balanced current distribution. A 24-element array made of two 12-element sets is shown schematically in Fig. 11-34 (reflectors are omitted from the drawing).

**All-Metal Construction**

Collinear arrays may be made very light in weight and low in wind resistance, and still have strength to withstand the most severe weather conditions, if all-metal design is employed in the manner shown in Figs. 11-30, 11-31 and 11-32. Elements, supporting arms, and vertical and horizontal supports are all of aluminum or dural tubing, and are held together by clamps made from sheet aluminum. Dimensions for the clamps required when the members are 1/4-inch, 3/4-inch and 1-1/2-inch tubing are given in Fig. 11-31. A model showing the method of assembling is shown in Fig. 11-30, and the method of assembling a 12-element array is given in Fig. 11-32.

The clamp method of assembly results in a strong structure that will hold its alignment indefinitely. Clamps for combinations of tubing sizes other than those given may be made by bending up clamps experimentally out of soft metal or cardboard, and then using these as templates for cutting and drilling the sheet aluminum. The stock should be 1/16 inch or heavier, and the clamps should be assembled with No. 8 or larger screws. Lock washers should be used under all nuts. Clamps and the screws and nuts should be sprayed with clear lacquer when the assembly is completed. Use two coats for maximum protection.

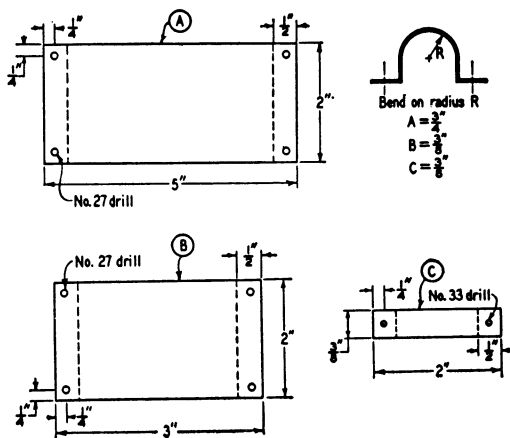

Fig. 11-31 — Detail drawings of the clamps used to assemble the all-metal 2-meter array. A, B and C are before bending into "U" shape. The right-angle bends should be made first, along the dotted lines as shown, then the plates may be bent around a piece of pipe of the proper diameter. Sheet stock should be 1/16-inch or heavier aluminum.

## QUADS FOR 144 MHZ

Though it has not been used to any great extent in vhf work, the quad antenna has interesting possibilities. It can be built of very inexpensive materials, yet its performance should be at least equal to other arrays of its size. Adjustment for resonance and impedance matching can be accomplished readily. Quads can be stacked horizontally and vertically, to provide high gain, without sharply limiting the frequency response.

### The 2-Element Quad

The basic 2-element quad array for 144 MHz is shown in Fig. 11-35. The supporting frame is 1 by 1-inch wood, of any kind suitable for outdoor use. Elements are No. 8 aluminum wire. The driven element is one wavelength (83 inches) long, and the reflector 5 percent longer, or 87 inches. Dimensions are not particularly critical, as the quad is relatively broad in frequency response.

The driven element is open at the bottom, its ends fastened to a plastic block, which is mounted at the bottom of the forward vertical support. The top portion of the element runs through the support and is held firmly by a screw running into the wood and then bearing on the aluminum wire. Feed is by means of 52-ohm coax, connected to the driven element loop.

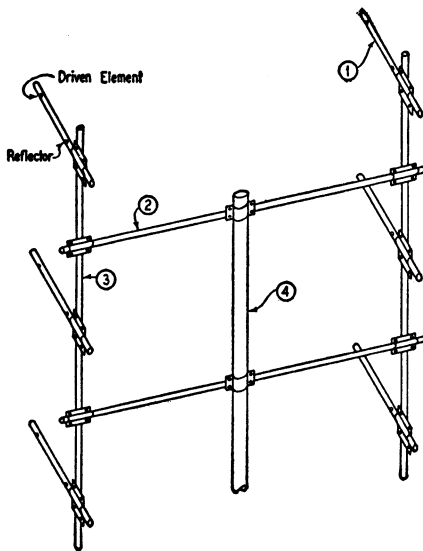

Fig. 11-32 — Supporting framework for a 12-element 144-MHz array of all-metal design. Dimensions are as follows: element supports (1)  $3/4$  by 16 inches; horizontal members (2)  $3/4$  by 46 inches; vertical members (3)  $3/4$  by 86 inches; vertical support (4) 1-1/2-inch diameter, length as required; reflector-to-driven-element spacing 12 inches. Parts not shown in sketch: driven elements  $1/4$  by 38 inches; reflectors  $1/4$  by 40 inches; phasing lines No. 18 spaced 1 inch, 80 inches long, fanned out to 3-1/2 inches at driven elements (transpose each half-wave section). The elements and phasing lines are arranged as shown in Fig. 11-29.

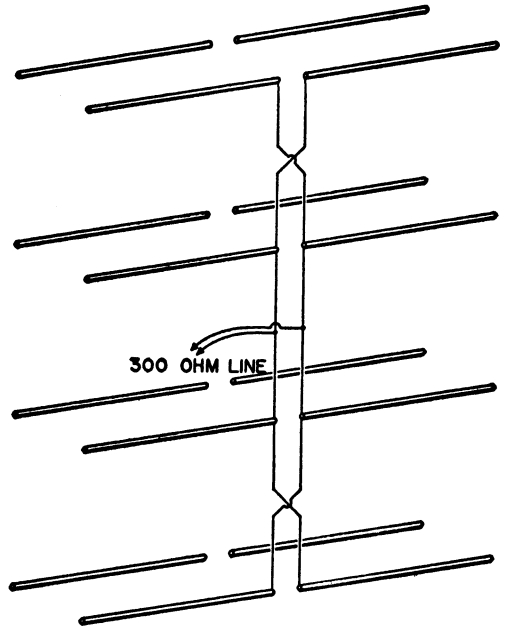

Fig. 11-33 — Schematic drawing of a 16-element array. A variable Q section may be inserted at the feed point if accurate matching is desired. Reflector spacing is 0.2 wavelength.

The reflector is a closed loop, its top and bottom portions running through the rear vertical support. It is held in position with screws, top and bottom. The loop can be closed by fitting a length of tubing over the element ends, or by hammering them flat and bolting them together, as shown in the sketch.

The elements in this model are not adjustable, though this can easily be done by the use of stubs. It would then be desirable to make the loops slightly smaller, to compensate for the wire in the adjusting stubs. The driven-element stub would be trimmed for length and the point of connection for the coax would be adjustable for best match. The reflector stub could be adjusted for maximum gain or front-to-back ratio, whichever quality the builder wished to optimize.

In the model shown only the spacing is adjusted, and this is not particularly critical. If the wooden supports are made as shown, the spacing between the elements can be adjusted for best match, as indicated in an SWR meter connected in the coaxial line. The spacing has little effect on the gain, from 0.15 to 0.25 wavelength, so the variation in impedance with spacing can be utilized for matching. This also permits use of either 52- or 72-ohm coax for the transmission line.

### Stacking

Quads can be mounted side by side or one above the other, or both, in the same general way as described for other antennas. Sets of driven elements can also be mounted in front of a screen

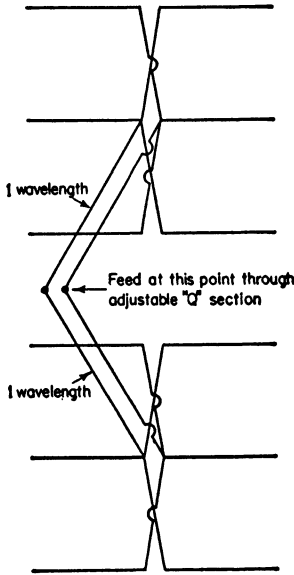

Fig. 11-34 — Method of feeding the driven elements of a 24-element array. Phasing lines may be open-wire line with 1/2 to 1 inch spacing between conductors.

reflector. The recommended spacing between adjacent element sides is a half wavelength. Phasing and feed methods can be similar to those employed with other antennas described in this chapter.

**Adding Directors**

Parasitic elements ahead of the driven element work in a manner similar to those in a Yagi array. Closed loops can be used for directors, by making them 5 percent shorter than the driven element, or about 79 inches. Spacings can be similar to those for conventional Yagis. In an experimental model built by W8HHS the reflector was spaced 0.25 wavelength and the director 0.15. A square array using four 3-element bays worked out extremely well.

Workers using quads on 144 MHz have reported reduced fading, compared with horizontal Yagis. Possibly this is due to the presence of some vertical polarization with the quad, making it less affected by polarization changes that tend to occur over long paths.

**LONG-WIRE ARRAYS FOR 50 AND 144 MHz**

Long-wire antenna systems such as the V or the rhombic can usually be used on 50 or even 144 MHz with good results even though they were erected with lower-frequency operation in mind. The included angles in such arrays will not be optimum for vhf, but the arrays will be so large, in terms of vhf wavelengths, that they will work well, particularly if the feeder systems are not too long. They will show little frequency discrimination over an entire vhf band.

Long-wire arrays may be constructed according to the principles given in Chapter Five, designing them specifically for vhf use. In such instances an effective rhombic array assumes proportions that make it usable in many amateur locations where a similar array for 7 or 14 MHz would be out of the question because of its great size. By proper choice of leg lengths a V or rhombic can be made to work well on both 28 and 50 MHz, making it a highly useful system where the necessary space is available for its erection. Several examples are given in Table 11-I.

The tilt angles and leg lengths in wavelengths for other combinations can be worked out from the design data in Chapter Five, using the curves for zero wave angle. The wire lengths in feet are then given by

$$Length \text{ (feet)} = \frac{492 (N - 0.05)}{Freq. \text{ (MHz)}}$$

where *N* is the number of half waves on the leg. The above formula need be used only where the leg length is short in terms of wavelength. For longer dimensions the standard half-wave formula may be used:

$$Length \text{ (feet)} = \frac{492 N}{Freq. \text{ (MHz)}}$$

Long-wire systems for combining operation on 50 and 144 MHz are even more attractive as to size. Because of the nearness to third-harmonic relationship which exists between these two bands, the same matching section and feeder may be used to feed a terminated rhombic for both bands with a flat line. Since a Q section can be any odd multiple of a quarter wavelength, the matching section for a two-band vhf rhombic can be a quarter wavelength long at 50 MHz, in which case it will be approximately three quarter waves long at 144 MHz. The feed impedance of a terminated rhombic is about 800 ohms; thus, a 490-ohm Q

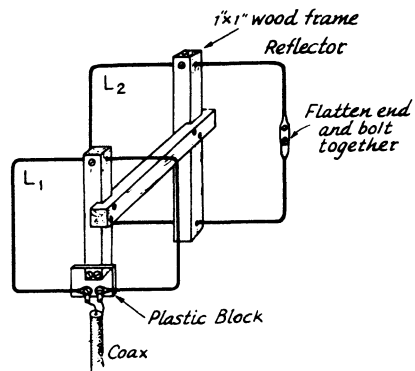
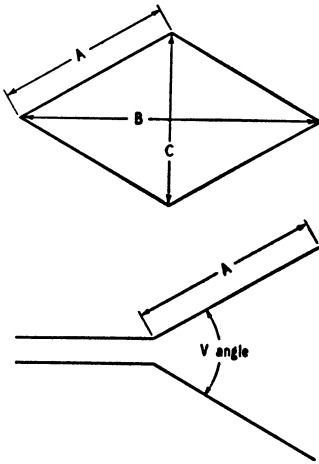

Fig. 11-35 — Mechanical details of a 2-element quad for 144 MHz. Driven element, L1, is one wavelength long; reflector, L2, 5 percent longer. Sets of elements of this type can be stacked horizontally and vertically for high gain with broad frequency response. Bay spacing recommended is 1/2 wavelength between adjacent element sides. Example shown may be fed directly with 52-ohm coax.

TABLE 11-I

Dimensions of V and Rhombic Antennas for VHF use. Columns 1 and 2 are for V Designs. For Rhombics use 1, 3 and 4.

Freq. (MHz)	Side Length "A" in Ft.	V Angle	Over-all Length "B" in Ft.	Width "C" in Ft.
50.5	58	60°	96.5	65.5
145	58	35°	109	39
28.7	68	70°	101.5	84
50.5	68	55°	106.5	70.6
145	68	35°	129	41
50.5	106	42°	192.5	91.5
145	106	35°	205	47.5
28.7	136	52°	237.5	133
50.5	136	37°	252.5	102



section is required to match this impedance to a 300-ohm line. Such a matching section could be made of No. 14 wire spaced 1-3/4 inches, about 53 inches long, as a compromise for the two bands. The array could be fed directly with a 600-ohm line, without appreciable mismatch. Preferably such a line would be of small wire, in order to keep the spacing to relatively small dimensions. See Chapter Three for wire sizes and line impedances.

Laying out a rhombic antenna for the vhf bands is somewhat less complicated than for lower frequencies, because it is usually possible to have the vhf array high enough (in terms of wavelengths) so that the effect of ground is a minor consideration. The dimensions given in Table 11-I

### ANTENNAS FOR 220 AND 420 MHZ

The use of high-gain antenna systems is virtually a necessity on 220 MHz and higher frequencies, if communication is to be carried on over other than line-of-sight distances. Experimentation with antenna arrays for these frequencies is fascinating, and the size of elements and supporting structures is such that various element arrangements and feed systems can be tried with ease. Arrays for 420 MHz, particularly, are ideal for scale-model demonstrations of antenna principles,

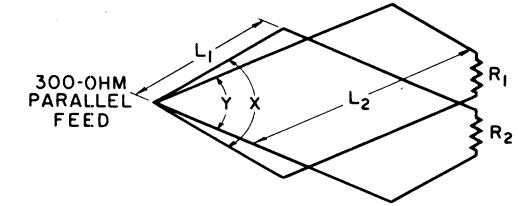

Fig. 11-36 — A 144-MHz rhombic with an estimated 27-dB gain over a dipole. The wires are all on the horizontal plane with the crossovers insulated.

- L1 — 29.5 feet
- L2 — 50.67 feet
- X — 52.2°
- Y — 37.7°
- R1-2 — 660 ohms, total wattage should equal half the power output of the transmitter.
- Height above ground — 12.29 feet
- Elevation angle — 7.5°
- Vertical beamwidth — 5.5°
- Horizontal beamwidth — 8.5°

are based on the assumption that the lowest possible radiation angle is desired, in which case one side should be a half wave longer than half the overall length. Using the terms of Table 11-I:

$$A = \frac{B}{2} + \frac{480}{\text{Freq. (MHz)}}$$

The shape of a multiband V or rhombic may be set up according to Table 11-I with its width, C, at the optimum value for the band where highest efficiency is desired. It will be noted that the larger the array the less difference there is in the included angles for adjacent bands. In other words, the larger the array the better will be its capabilities for multiband operation.

### AN IMPROVED RHOMBIC FOR 144 MHZ

A rhombic with improved performance (Fig. 11-36) was designed by Mike Staal, K6MYC, based on specifications given by E. A. LaPort and A. C. Veldhuis. It features lower sidelobes than previous types, and has an estimated gain of 27 dB over a dipole.

The narrow beamwidth reduces the usefulness of this antenna for general purposes, but for a specific path or EME window it should be very effective. It has been used by several European and U. S. amateurs.

as even high-gain systems may be of table-top proportions.

Any of the arrays already described may be scaled down for use on 220 and 420 MHz by reducing all dimensions in proportion to the wavelength, or in inverse proportion to the frequency. Using 144-MHz designs as a base, the scale factor is 144/220, or 0.655, for converting a 144-MHz antenna design to 220 MHz, and 144/420, or 0.343, for converting 144 MHz to



420. Using the scale factor requires reducing *all* dimensions, including the element diameters. However, if a different length/diameter ratio is used in the elements the proper lengths can be found from Fig. 11-1. In most cases the necessary modification will not be large.

On 220 and 420 MHz the broad frequency response and ease of adjustment of collinear systems make them more attractive than the more critical Yagi configurations. The use of plane and corner reflectors becomes practical from the standpoint of overall size, and even parabolic reflectors are usable. Additional details of parabolic reflectors may be found in Chapter Twelve.

**SCREEN-REFLECTOR ARRAYS**

At 220 MHz and higher, where their dimensions become practicable, plane-reflector arrays are widely used. Except as it affects the impedance of the system, as shown by the curve marked 180° in Fig. 11-37, the spacing between the driven elements and the reflecting plane is not particularly critical. Maximum gain occurs around 0.1 to 0.15 wavelength, which is also the region of lowest impedance. Highest impedance appears at about 0.3 wavelength. With a spacing of 0.22 wavelength between the driven elements and the screen reflector, the impedance of the elements approximates that of a dipole in free space. As the gain of a plane-reflector array is nearly constant at spacings from 0.1 to 0.25 wavelength, the spacing may be varied to obtain an impedance match.

An advantage of the plane reflector is that it may be used with two driven-element systems, one on each side of the plane, providing either for two-band operation or the incorporation of horizontal and vertical polarization in a single structure. The gain of a plane-reflector array is slightly higher than that of a similar number of driven elements backed up by parasitic reflectors. The plane-reflector array also has a broader frequency response and higher front-to-back ratio. To achieve these ends, the reflecting plane must be larger than

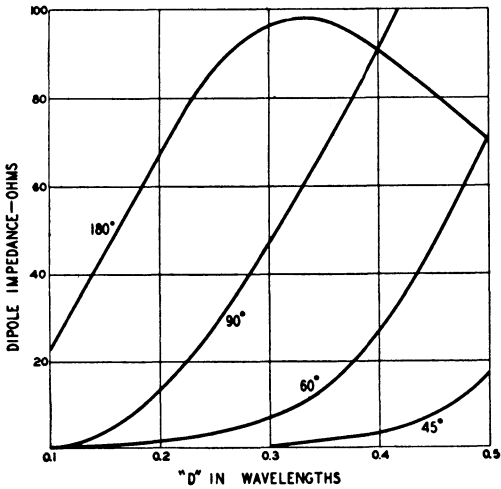

Fig. 11-37 — Feed impedance of the driven element in a corner-reflector array, for various corner angles of 180 (flat sheet), 90, 60 and 45 degrees.

the area of the driven elements, extending at least a quarter wavelength on all sides. Chicken wire on a wood or metal frame makes a good plane reflector. Closely spaced wires or rods may be substituted, for lower wind resistance, with the spacing between them running up to 0.1 wavelength without appreciable loss in effectiveness.

**The Corner Reflector**

When a single driven element is employed, the plane reflector may be bent to form an angle, giving an improvement in the radiation pattern and gain. At 220 and 420 MHz its size assumes practical proportions, and it can even be used at 144, though usually at less than optimum size.

The corner angle can be 90, 60, or even 45 degrees, but the side length must be increased as the angle is narrowed. The driven-element spacing

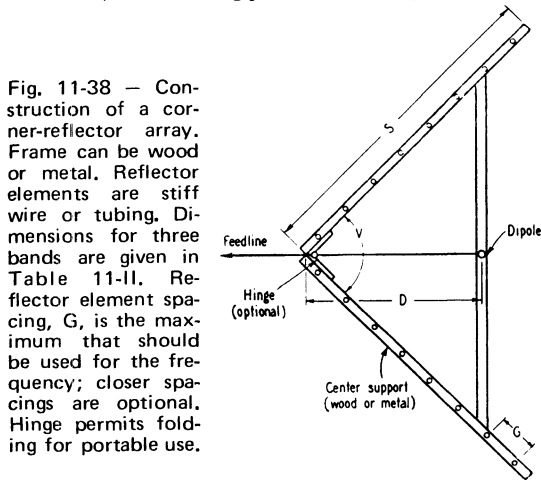
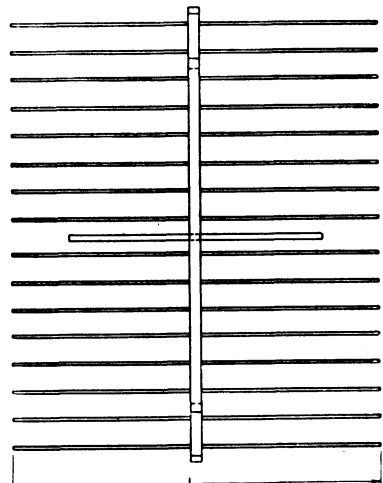

Fig. 11-38 — Construction of a corner-reflector array. Frame can be wood or metal. Reflector elements are stiff wire or tubing. Dimensions for three bands are given in Table 11-II. Reflector element spacing, G, is the maximum that should be used for the frequency; closer spacings are optional. Hinge permits folding for portable use.



**TABLE 11-II**  
**Dimensions of Corner-Reflector Arrays for 144, 220, and 420 MHz**

<i>Band (MHz)</i>	<i>Side Length "S" (Inches)</i>	<i>Dipole to Vertex "D" (Inches)</i>	<i>Reflector Length "L" (Inches)</i>	<i>Reflector Spacing "G" (Inches)</i>	<i>Corner Angle "V" (Degrees)</i>	<i>Feed Im- pedance (Ohms)</i>
144*	65	27.5	48	7-3/4	90	70
144	80	40	48	4	90	150
220*	42	18	30	5	90	70
220	52	25	30	3	90	150
220	100	25	30	screen	60	70
420	27	8-3/4	16-1/4	2-5/8	90	70
420	54	13-1/2	16-1/4	screen	60	70

\*Side length and number of reflector elements somewhat below optimum — slight reduction in gain.

from the corner can be anything from 0.25 to 0.7 wavelength for a 90-degree corner, 0.35 to 0.75 for a 60-degree one, and 0.5 to 1 for a 45-degree corner. Feed impedance for various corner angles and spacings is given in Fig. 11-37. Since the spacing is not critical as to gain, it may be varied to achieve impedance matching.

Gain with a 60- or 90-degree corner with 1-wavelength sides runs about 10 dB. A 60-degree corner with 2-wavelength sides has about 12 dB gain. It will be seen that this is not outstanding for the size of such an array, but there are other advantages. A corner may be used for several bands, for example, or perhaps for uhf television reception, as well as for amateur uhf work.

A suggested arrangement for a corner reflector system is shown in Fig. 11-38. Sheet metal or wire mesh may be used with equal effectiveness for the reflecting plane. A series of rods, as shown, is equally good, if the space between them is kept under 0.06 wavelength at the highest frequency for which the reflector is to be used. The frame may be made of wood, with a hinge at the corner to facilitate portable work or assembly atop a tower. Principal dimensions for corner-reflector arrays for 144, 220, and 420 MHz are given in Table 11-II. These dimensions are not critical, because of the broad frequency response of any plane-reflector system.

### YAGIS FOR 220 AND 432 MHZ

Moderate-size Yagis for the 220- and 420-MHz bands can be built at very low cost, and with only simple tools, if the suggestions of Figs. 11-39 and 40 are followed. Booms are 1 × 1-inch wood, available in any lumberyard. (Your dealer will call it "one by one" but the actual size will be more like 3/4 × 7/8 inch.) Be sure that it is straight, dry, and free of knots. Take the man's advice as to which kind of wood will be best for outdoor use, as available stocks vary around the country. Prime and paint it thoroughly, if you want the array to last well.

An 11-element array is shown for 432 MHz, and a 7-element one for 220 MHz, both using element spacings and lengths that are close to

optimum for gain. The antenna should be supported near its mechanical balance point, roughly 2 feet from the reflector end. If a TV-type U clamp is used, it is well to bend up a U-shaped metal plate the width of the boom and about 3 inches long, and slip it over the boom at the point where the holes are to be drilled for the clamp. This protects the boom from crushing when the U-clamp nuts are tightened, and leaves it strong enough to stand up well without bracing. Gusset plates of wood or Masonite make stronger assemblies.

Parasitic elements in the 432-MHz model are made of 3/32-inch aluminum welding rod, and 1/8-inch rod is used for the 220-MHz model. This material can be purchased very reasonably at welding supply houses, usually in 3-foot lengths. Any stiff wire or rod up to 1/8 inch diameter will do. Drill the boom for a hole size that will just take the elements with a force fit, then run a 1/2-inch brass or aluminum screw into the boom to bear on the element and hold it in place. The screws can then be bonded together and connected to ground for lightning protection, if desired.

The driven elements originally tried were step-up folded dipoles similar to those used in the 144-MHz Yagis, but it was found that these did not work well at 220 and 432 MHz. This is probably the result of the spacing between the two parts of such a dipole being a considerable portion of a wavelength at these frequencies. The 432-MHz Yagi was made with a driven element of the same material as the parasitic elements, mounted as shown in Fig. 11-39A and B. Blocks of insulating material 1/4 inch thick and 1-1/2 inches square are fastened to the boom with two 1-1/2-inch brass screws and nuts. The upper portion of the dipole runs through the boom, just above the center, and the lower is held in place with 4-40 nuts on either side of the insulating plates, as shown in the end view, B. The 3/32-inch rod is easily threaded for 4-40, if this is done before the element is bent. The total length of the wire is about 25 inches. An alternative to threading is to hammer the ends flat, and drill for 4-40 screws.

The antenna is matched by means of a universal stub, shown in Fig. 11-39C, made of the same material as the elements. It should be cut about 15

Fig. 11-39 — Details of a 6-foot 11-element Yagi for 432 MHz. The square boom and one polystyrene mounting block for the driven element are shown at A. The blocks, element, and boom are shown in detail in the end view, B. Matching stub, C, fastens to ends of the driven element, and is mounted under the boom between two poly blocks. Element lengths and spacings for the middle of the 420-MHz band are shown in the side view of the complete array.

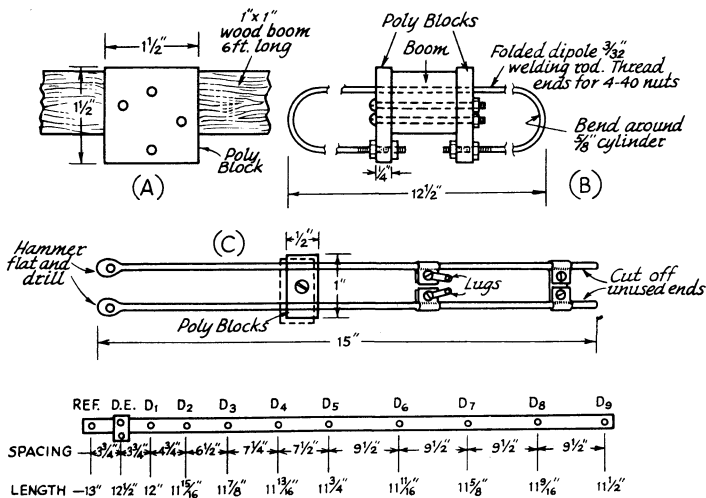

inches long, and suspended under the boom. An adjustable short and two sliding clips for connecting the transmission line or balun are provided for adjusting the matching. The ends of the stub that are connected to the dipole are pounded flat with a hammer, and then drilled to pass the threaded ends of the dipole. These are held in place by the 4-40 nuts shown in B. A ceramic cone standoff insulator (not shown in the drawing) is fastened to the underside of the boom. Two pieces of polystyrene similar to that used for the dipole mounting blocks, one above and one below the matching stub, are fastened to this cone, clamping the stub in place.

The short and the point of connection of the balun are adjusted for zero reflected power, as indicated by an SWR meter connected in the line.

The 220-MHz Yagi can be made in the manner just described, using a dipole made of a single piece of wire. The universal stub for matching should be about 28 inches long, to assure an adequate range of adjustment. A variation of the ratio-type folded dipole was made for the 220-MHz antenna as shown at B in Fig. 11-40. Here a flat strip of aluminum comprised the fed portion of the dipole, and a 3/8-inch tube the unbroken portion. The aluminum strip is bolted to the underside of the

tubing at the outer ends. The slope down to the feed point at the polystyrene blocks determines the impedance. With the dimensions shown the array can be fed with 52-ohm coax and a balun, connected to the lugs at the insulating plates. The SWR is under 1.5 to 1 from 220 to 224 MHz, with optimum match at about 221.5 MHz.

### A 13-ELEMENT YAGI FOR 432 MHZ

A Yagi with high performance has been developed by K2RIW and duplicated by many uhf enthusiasts with excellent results. It is attractive from the construction standpoint as well because of the aluminum boom, which has an excellent strength-to-weight ratio. The uncertainty of the detuning effect from all-metal construction is alleviated by mounting the elements in small plastic blocks, Fig. 11-41.

For those who like to experiment with antennas, this method of element fastening is ideal. The block and element assembly may be held in place on the boom by a rubber band or a nylon tie of the variety used to secure cables. Changing the position of the elements to check the gain or pattern characteristics of an antenna becomes easy with this temporary fastening. After the best

Fig. 11-40 — Seven-element 220-MHz Yagi on a 6-foot wood boom. Poly blocks located on each side of the boom support the modified folded-dipole driven element. The latter has a sloping lower portion, for matching 52-ohm coax. A balun is connected to the lugs shown at the bottom of sketch B. With element lengths and spacings given in the side view of the array, optimum performance is obtained over the first 3 to 4 megahertz of the band.

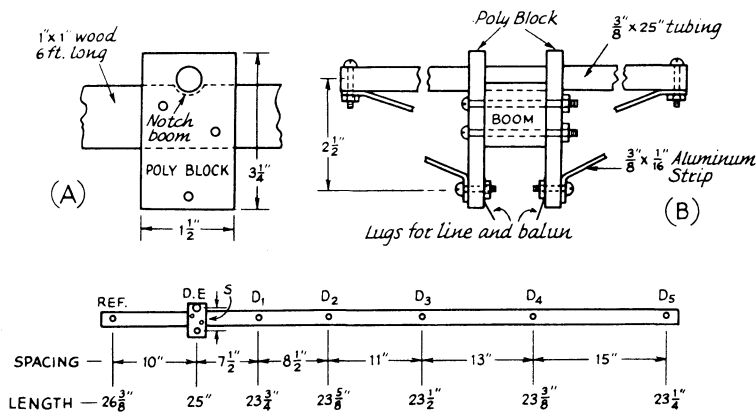

Element	Length		Spacing from DE	
	Inches	cm	Inches	cm
R	13-5/16	33.813	6-1/4	15.875
DE	12-3/8	31.432		
D1	11-3/4	29.845	3	7.62
D2	"	"	5-11/16	14.44
D3	"	"	9-1/16	23.01
D4	"	"	14-9/16	36.98
D5	"	"	22-1/16	56.03
D6	"	"	33-7/8	86.04
D7	"	"	44-1/2	113.03
D8	"	"	55-1/8	140.01
D9	"	"	65-3/4	167.00
D10	"	"	76-3/8	193.99
D11	"	"	87	220.98

R — Reflector; DE — Driven Element; D — Director

position is found, the plastic block can be secured to the boom with aluminum pop rivets.

Anyone who is not so experimentally inclined can duplicate the antenna with the dimensions given in Table 11-III and obtain good results. This type of Yagi has been used by several entrants in antenna gain-measuring contests where gain figures for individual Yagis made to these dimensions were better than 15 dB over a dipole. Four-bay Yagi arrays have been consistent winners of such contests.

It should be emphasized here that the boom diameter, element diameter, element-to-boom spacing, and boom shape are all interrelated factors, and a change in any one of them will require complete retuning of the Yagi for best gain. If the builder is not equipped to measure gain with sensitive and accurate equipment, then he should follow the instructions precisely.

The lengths of the elements will be found to be more critical than the spacing. Tolerances should be to 1/64 inch. The feed is arranged for 200 ohms, such as 52-ohm coax and a 4-to-1 balun. A good balance point for mounting the Yagi should be between directors five and six.

**2-BAY AND 4-BAY ARRAYS FOR 432 MHZ**

The 432-MHz Yagis described above can be used effectively in stacked pairs, or in a 4-bay

system, as shown in Fig. 11-42. The array is fed with a universal stub and a coaxial balun.

If the individual Yagis are of the wood-boom construction, the framework for supporting them in 2- or 4-bay arrays can be of the same size material. For arrays of all-metal construction, the supporting framework can be of the same or slightly larger size tubing as that for the boom. Suitable diagonal bracing is a must for either type of assembly.

Each individual Yagi in the array should be adjusted for a good match, preferably with the system pointing straight up at a clear area. After the phasing harness is connected, the short on the universal stub and the position of the balun connection should be moved in small increments for best match to the feed line.

**VERTICAL POLARIZATION OF YAGI ANTENNAS**

Of considerable interest to amateurs using vhf fm is a vertically polarized antenna with some directional gain. This type of antenna would be useful for gaining access to a repeater from some distance away or if the operator is using a low-powered transmitter. It is also helpful in communicating on the commonly accepted simplex frequencies, where it is desirable to match the polarization of the antenna on the mobile station.

Most Yagi antennas or arrays, as described earlier in this chapter, may be mounted with the elements in a vertical plane. Individual Yagis may be stacked in varied configurations, one above the other, side-by-side, or in groups of four or more. There is only an insignificant difference in perfor-

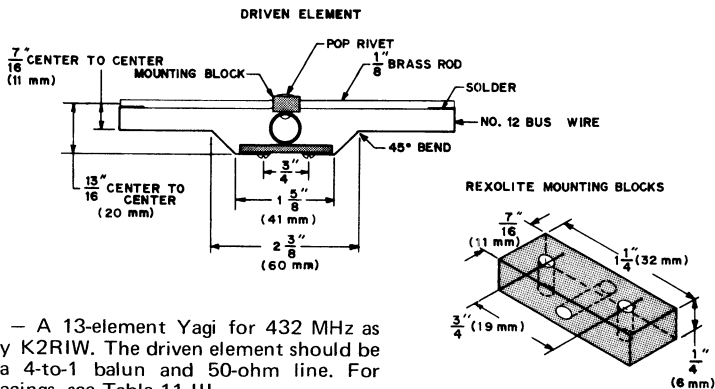
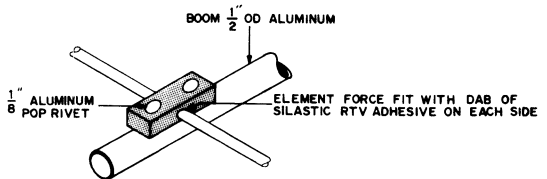

Fig. 11-41 — A 13-element Yagi for 432 MHz as designed by K2RIW. The driven element should be fed with a 4-to-1 balun and 50-ohm line. For element spacings, see Table 11-III.

MOUNTING ARRANGEMENT, ALL ELEMENTS



REXOLITE MOUNTING BLOCKS

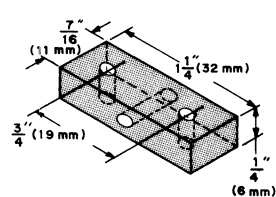
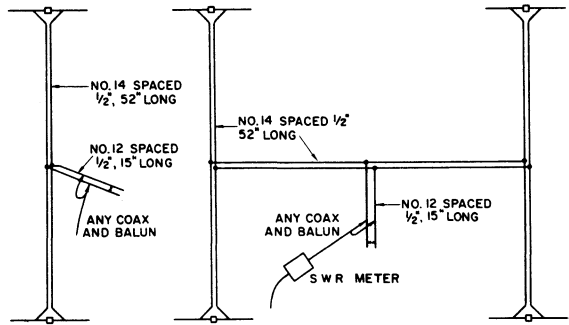

Fig. 11-42 — Phasing arrangements for two and four 432-MHz 11-element Yagis. Bay spacing of approximately two wavelengths is set by the length of the phasing lines. The universal-stub matching device may be used with any type of transmission line, as well as with the coaxial line and balun as shown.



mance of such arrays, whether the elements are vertical or horizontal.

The one consideration that must be applied to a vertically polarized Yagi or array is that the support must not disturb the beam pattern. For a single Yagi mounted as in Fig. 11-43A, the vertical support should be of wood or other nonconducting material where it is in the vicinity of the active elements of the beam. A good rule of thumb would be to make the support from a nonmetallic

material for at least 1/4-wavelength beyond the tip of the nearest element. Any diagonal bracing for the boom should also be nonmetallic.

Another method of mounting vertically polarized Yagis is to place two of them side-by-side, as in Fig. 11-43B, with 1-wavelength spacing between the two booms. The main support will be in the center of the boom, which allows 1/2-wavelength of space to the nearest element. In this case, the support mast and the boom can both be of metal.

## NONDIRECTIONAL VHF ANTENNAS

Most amateur vhf communication is carried on with directive arrays of one kind or another, but in some types of work it is desirable to radiate power equally in all directions. For such work vertical polarization is generally used. Any of the dipole arrangements mentioned earlier in this chapter will give essentially uniform radiation patterns when mounted in a vertical position, but there are modifications that are better adapted to such service.

### Ground-Plane Antennas

When an antenna is mounted at the top of a metal mast, standing waves may develop on the mast or on the coaxial cable used to feed the antenna if the support is nonmetallic. When this occurs, radiation from the mast combines with that from the antenna to raise the angle of radiation, thereby reducing the effectiveness of the system. The ground-plane type of antenna has largely

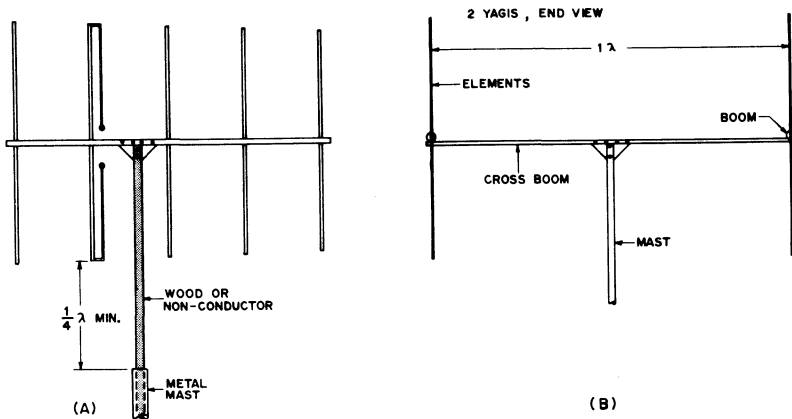

Fig. 11-43 — Methods of mounting Yagi antennas with the elements vertical. The boom-to-mast joint may be strengthened by a gusset plate. If the arrays are large enough to require diagonal bracing, such bracing should be of nonconducting material where it is close to the elements.

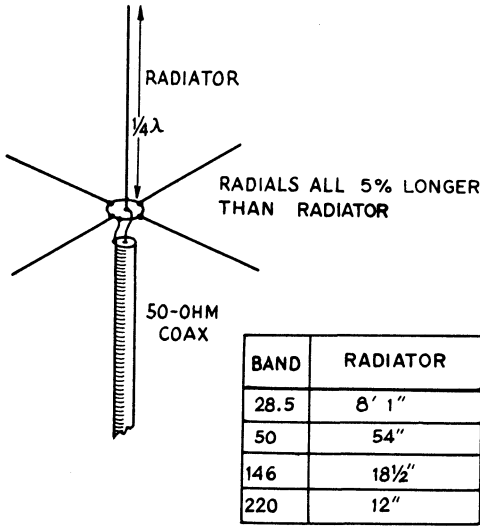

Fig. 11-44 — The simple 1/4-wavelength ground plane.

overcome this problem because the horizontal ground plane is an effective shield between the antenna and mast. The fundamental principles of the ground plane are given in Chapter Two, and matching it to commonly available feed lines is discussed in Chapter Three.

Dimensions for ground-plane antennas for some popular vhf bands are given in Fig. 11-44. For a more precise match to the transmission line, a shorted 1/4-wave stub may be connected in parallel with the antenna at the feed point. If this is done, a slight shortening of the driven element will be necessary.

### A COMBINATION 6- AND 2-METER J POLE

Credit for this J-Pole system goes to W5WEU who has used these two antennas as omnidirectional radiators with excellent results. The overall antenna is shown in Fig. 11-45. The antenna mast is 1-1/4-inch diameter pipe, 20 feet long. This length can be made up from two 10-foot lengths of TV masting. The first step is to make the 2-meter J pole as shown in Fig 11-46. Note that the stub dimension of 19 inches is the total length above the metal support brackets.

Once the stub is mounted, the antenna can be temporarily supported in a vertical position. Connect an SWR indicator in the feed line, and slide the outer braid of the coax (touching the main mast) and the inner conductor (touching the stub) up and down until you get a low SWR. The point where the SWR is the lowest is where the hole will be drilled in the main mast for the coax. (The coax will be snaked up inside the main mast.) Temporarily ground the braid with a self-tapping screw at the point of lowest SWR. Next, carefully adjust the inner conductor up or down the stub until a match is obtained. At the point of matching, drill

another hole to take a self-tapping screw for connecting the inner conductor.

The same procedure is used on six meters. However, on this band, the coax is brought up outside the mast in permanent installation. The dimensions shown in Fig. 11-47 will provide a starting point for adjustments. The antennas shown are used on 146.5 and 52.525 MHz.

The completed antenna can be mounted on the top of a tower or mast, providing omnidirectional coverage. Gain of these antennas is the same as that of a vertical half-wave dipole. The coax and feed points should be waterproofed with a good sealing compound.

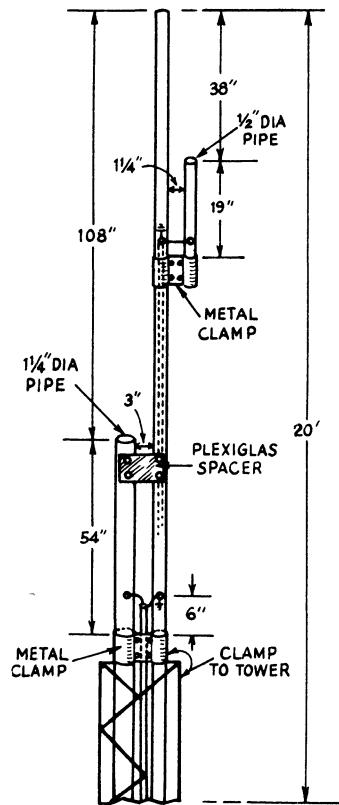

Fig. 11-45 — Constructional details for the 2- and 6-meter J poles.

MULTIELEMENT ARRAYS

Many of the repeater installations in the country use either stacked half-wave dipoles or stacked coaxial elements. Also, most repeater owners use commercially manufactured antennas. There is no doubt that the antenna manufacturer has an advantage over the home constructor simply because of the tooling and material-procurement advantages. However, the home builder *can* make gain arrays which are as good as or better than manufactured antennas. The antennas described next are practical arrays that are not difficult to make and have been used in the field with excellent results.

A 6-DB GAIN OMNIDIRECTIONAL ARRAY

The antenna shown in Figs. 11-48 and 11-49 was designed by W2EWY and WB2ICP, adapting some of the more attractive features of commercial arrays. Excellent results have been obtained with this antenna in use at a repeater site.

Basically, the antenna consists of four stacked, grounded, half-wave dipoles, fed off-center, providing a 6-dB gain (omnidirectional) or 9 dB with an offset pattern. One problem in antenna installations is static-type noise. The grounded-dipole configuration has the advantage of reducing this type of noise appreciably.

Fig. 11-49 at A shows the details for one of the elements. The two sides and ends of the elements are made from 1/2-inch aluminum angle stock, available in eight-foot lengths from many hardware

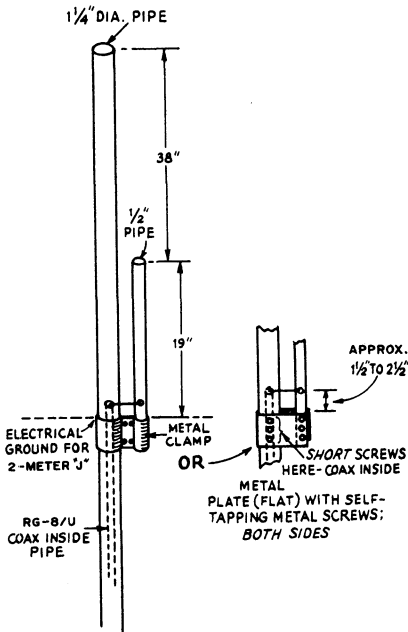

Fig. 11-46 - Details of the 2-meter J pole.

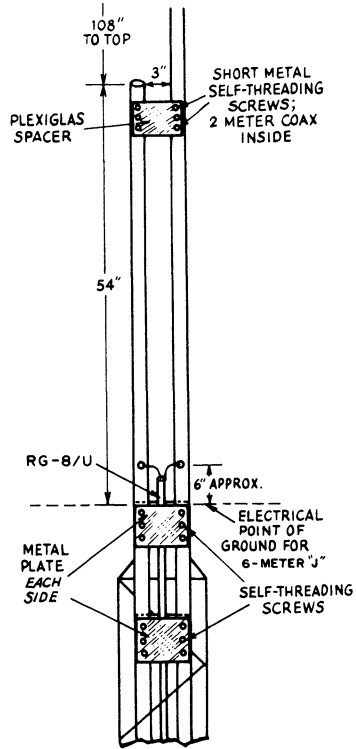

Fig. 11-47 - Details of the 6-meter J pole.

dealers. A single eight-foot section will make one element. The element supports are also made from the same type of angle stock.

Fig. 11-49 also shows the details of the phasing harness which is made from RG-59/U. Lengths A, B, C, and D are each 40.8 inches long from the dipole feed to the center of the T. Lengths E and F are each 63.8 inches long from center of T to center of T.

If the four elements are mounted in line on the TV-mast section, the pattern will be offset with a null in the direction of the supporting mast. The four dipoles can be positioned *around* the mast to provide an omnidirectional pattern. No matching is needed with this antenna. Of several units built from the specifications given, the SWR was below 1.2 to 1.

A COLLINEAR-COAXIAL ARRAY

The antenna shown in Fig. 11-50 is an excellent array for home station or repeater use. The antenna will provide from 6- to 9-dB omnidirectional gain, depending on the number of elements used. This system is one that has been around for years. The refinements shown here were developed by K2CBA, K1DEU, and WA1KJI.

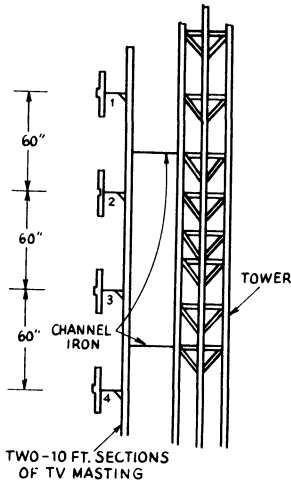

Fig. 11-48 - Spacing and arrangement of the four phased half-wavelength dipoles.

The antenna is a multiple of 1/2-wavelength elements with 1/4-wavelength sections on each end and a 1/4-wave stub at the feed point to reduce feed-line radiation. The dimensions shown are for 146 to 147 MHz, but the antenna can be made for other bands and frequencies.

In order to provide the same amount of gain as would be obtained with stacked dipoles, a larger number of half-wave sections are required. One of the reasons for antenna gain is the spacing between antenna sections. The four stacked dipoles previously described approach optimum spacing for maximum gain. In the coaxial-collinear arrangement shown, there is always the problem that as sections are added, the antenna current decreases from one section to the next. In other words, one end of the antenna is not radiating as much power as the other end. Slightly more than twice the number of elements are required to obtain the same amount of gain as with stacked dipoles. Where four stacked dipoles as described provide slightly less than 6 dB omnidirectional gain, it

takes eight half-wave coaxial elements, connected end-to-end, to obtain the same gain figure.

However, the coaxial-collinear antenna has certain advantages when installation problems are considered. The completed antenna is encased in either Plexiglas or PVC pipe and can be mounted above the supporting tower to get best omnidirectional coverage without the tower interfering with the antenna pattern.

**Construction**

From the formula 492 divided by the frequency in MHz, calculate a half-wavelength for the desired frequency. This comes out to 3.4 feet, or 40.4 inches for 146 MHz. Next, select the type of

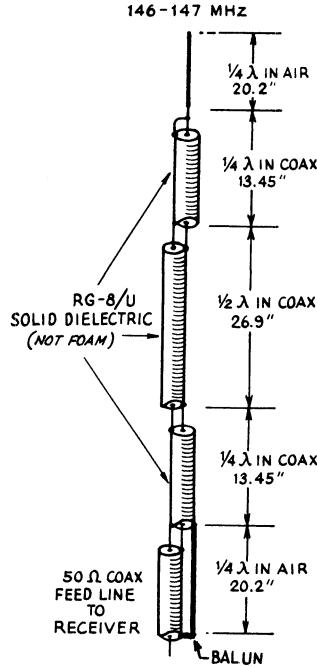

Fig. 11-50 - Basic details of the coaxial-collinear antenna. See fig. 11-9A for balun details.

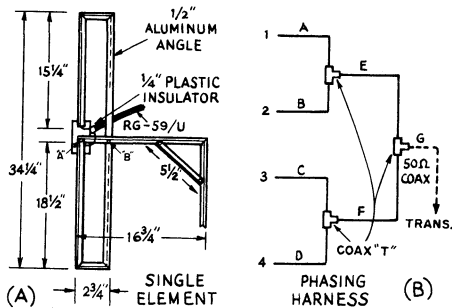

Fig. 11-49 - At A, constructional details of one of the dipole elements of Fig. 11-48. The phasing harness is shown at B.

coax you plan to use and get the velocity factor. Generally, the velocity factor for the solid-dielectric lines is 0.66 and 0.81 for foam dielectric. The antenna shown in Fig. 11-50 is based on the solid-dielectric coax, 0.66 velocity factor. Using this type of coax provides a shorter overall length for the antenna.

The first step in fabricating the antenna is to make a 3-element version (3 half-waves plus the 1/4-wave top element, the 1/4-wave coax section, and the bottom 1/4-wave section). Figs. 11-51 and 11-52 show the details for making the coaxial sections. The top section can be made from a piece of copper tubing or No. 12 wire.

When the antenna is completed, suspend it clear of any metallic objects. Using a low-power transmitter and SWR meter, make a check across the band to determine if the antenna is high or low in frequency. The lowest SWR reading will occur at



resonance. If this is not within  $\pm 1$  MHz of the desired frequency, trim the half-wave elements accordingly. More than likely, this will not be required. Also, don't be concerned about the specific SWR at this time. Look only for the minimum reading.

Depending on whether resonance is too high or too low in frequency, alter another pair of half-wave elements, making them 1/4- to 1/2-inch longer if the antenna is too high in frequency, or a like amount shorter if the antenna is too low in frequency. Continue this operation, adding pairs of elements until you reach the desired length. Eight half-wave elements will provide about 6 dB of gain and 16 elements will give approximately 9 dB of gain.

- 1) Cut to desired length plus 2".



- 2) Cut insulation back 1" on each end. Flux and tin each end, allow to cool.

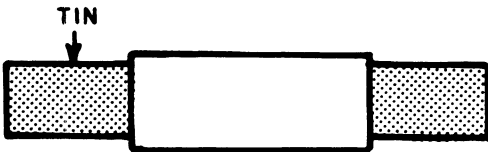

- 3) Using tubing cutter, cut shield off 3/4" from first end. Measure off final dimension from shield on cut end to other end, mark, and cut shield with tubing cutter.

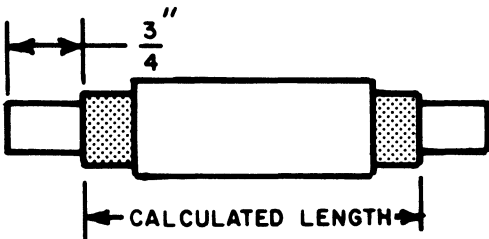

- 4) Using single-edge razor blade, trim insulation leaving 1/16" to 1/8" remaining.

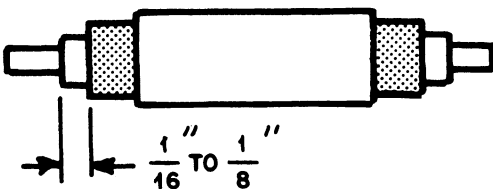

Fig. 11-51 — Method of element preparation.

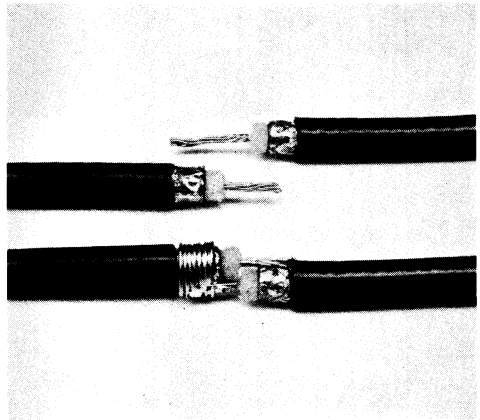

Fig. 11-52 — This shows the prepared end of one of the coax sections and also the method of joining two sections together.

Next, tape each connection with a good grade of electrical tape, applying several layers. This will provide mechanical strength and weatherproofing. With the several arrays that were built using this design, the SWR was always below 1.3 to 1 at the design frequency.

The antenna can be housed inside 1-3/4-inch diameter PVC pipe. Also, a new type of pipe has recently become available from plumbing supply dealers. This is fiberglass pipe and is available in 25-foot lengths with diameters starting at 2-1/2 inches. The ends of this pipe are tapered so that it can be joined to another section. The fiberglass pipe is extremely flexible without danger of breaking so it can be supported at one end, such as at the top of a tower, permitting the antenna to be in the clear.

**Bibliography**

Source material and more extended discussion of topics covered in this chapter can be found in the references given below.

Campbell, "Turnstile for Two," *QST*, April, 1959.

Kasper, "Array Design with Optimum Antenna Spacing," *QST*, Nov., 1960.

Kmosko and Johnson, "Long Long Yagis," *QST*, Jan., 1956.

Kraus, "The Square Corner Reflector Beam Antenna," *QST*, Nov., 1940.

LaPort and Veldhuis, "Improved Antennas of the Rhombic Class," *RCA Review*, March, 1960.

Linde, "5-Over-5 for Six," *QST*, Aug., 1970.

McCoy, "Five-Element Two-Meter Beam for \$1.50," *QST*, Oct., 1962.

Tilton, "Portable Antennas for 50 and 144 Mc.," *QST*, Aug., 1955.

Tilton, "Six Elements on 6," *QST*, Oct., 1957.

Tilton, "V.H.F. Antenna Facts and Fallacies," *QST*, Jan., Feb., Mar., 1963.

"Antenna Couplers for 50 and 144 Mc.," *QST*, July, Sept., 1956.

"The World Above 50 Mc.," *QST*, April, 1967.

*The Radio Amateur's VHF Manual*, ARRL.

*FM and Repeaters for the Radio Amateur*, ARRL.

# Antennas for Space Communications

Space and satellite communications require consideration of the effects of polarization and angle of elevation, along with the azimuth of either a transmitted or received signal. Normally, provisions for polarization are unnecessary on the hf bands, since the original polarization direction is lost after the signal passes through the ionosphere. A vertical antenna will receive a signal emanating from a horizontal one, and the converse is true when transmitting and receiving antennas are interchanged. Neither is it worth the effort to make provisions for tilting the antenna, since the elevation angle is so unpredictable. However, with satellite communications the polarization changes, and a signal that would disappear into the noise on a normal antenna might be S9 on one that is insensitive to polarization direction. Angle of elevation is also important from the standpoint of tracking and avoiding indiscriminate ground reflections which might cause nulls in signal strength.

## CIRCULAR POLARIZATION

The ideal antenna for random polarization would be one with a circularly polarized radiation pattern. Two commonly used methods for obtaining circular polarization are the crossed Yagi, as shown in Fig. 12-1, and the helical antenna, as described later in this chapter. The crossed Yagi is mechanically simpler to construct, but harder to adjust than its helical counterpart.

Polarization sense may also be a factor, especially if the satellite uses a circularly polarized antenna. In physics, clockwise rotation of an *approaching* wave is called "right circular polarization," but the IEEE standard uses the term "clockwise circular polarization" for a *receding* wave. Either clockwise or a counter-clockwise sense can be selected by reversing the phasing harness of a crossed Yagi antenna. The sense of a helical antenna is fixed, being determined by its physical construction.

Mathematically, linear and circular polarization are special cases of elliptical polarization. Consider two electric-field vectors at right angles to each other. The frequencies are the same, but the magnitudes and phase angles can vary. If either one or the other of the magnitudes is zero, linear polarization results. If the magnitudes are the same and the phase angle between the two vectors (in

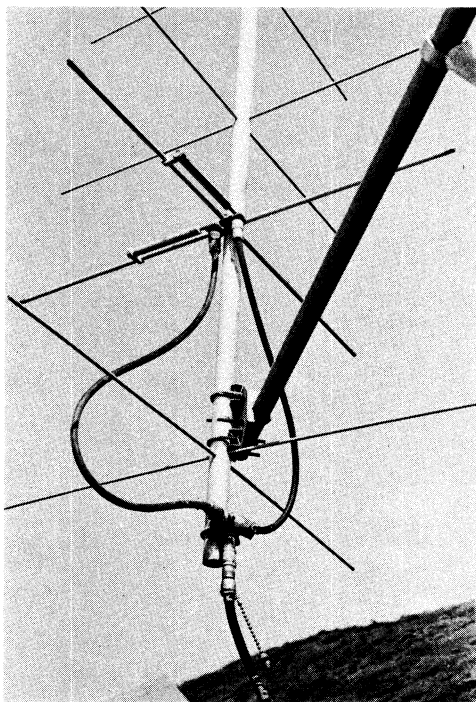

Fig. 12-1 — This vhf crossed Yagi antenna design by KH6IJ was presented in January 1973 *QST*. Placement of the phasing harness and T connector is shown in the lower half of the photograph. Note that the gamma match is mounted somewhat off of element center for better balance of rf voltages on elements.

time) is 90 degrees, then the polarization is circular. Any combination between these two limits gives elliptical polarization.

## CROSSED LINEAR ANTENNAS

A dipole radiates a linearly polarized signal, and the polarization direction depends upon the orientation of the antenna. Fig. 12-2 shows the electric field patterns of horizontal and vertical dipoles at A and B. If the two outputs are combined with the correct phasing (90 degrees), a circularly polarized

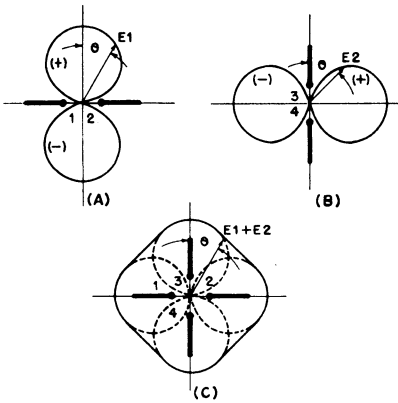

Fig. 12-2 — Radiation patterns looking head-on at dipoles.

wave results, and the electric field pattern is shown in Fig. 12-2C. Notice that since the electric fields must be identical in magnitude, the power from the transmitter must be equally divided between the two antennas; hence the gain of each one is decreased by 3 dB when taken alone in the plane of its orientation.

As previously mentioned, a 90-degree phase shift must exist between the two antennas. The simplest way to obtain the shift is to use two feed lines with one section a quarter wavelength longer than the other one. These two separate feed lines are then paralleled to a common transmission line which goes to either the transmitter or receiver. Therein lies one of the headaches of this system, since the impedance presented to the common transmission line by the parallel combination of the other two sections is one half that of either one of them taken alone (normally not true when there is interaction between loads, as in phased arrays). Another factor to consider is the attenuation of the cables used in the harness, along with the connectors. Good low-loss coaxial line should be used, and connectors such as type N are preferable to the UHF variety.

**A Practical Antenna**

The crossed Yagi array shown in Fig. 12-3 is part of the final design for a system used in satellite transponder stations. After various kinds of matching sections were tried, it was found that the simplest one worked best. The 90-degree phase shift is realized by making section "A" a quarter wave longer electrically than section "B." The characteristic impedance of these sections should be such that, when paralleled, they match the main feed line.

RG-133/U (95 ohms), made by Consolidated Wire Co., is ideal but is a hard item to find. More commonly found in stock is RG-63/U (125 ohms). There is some mismatch when using RG-63/U with a 50-ohm main feed line, but it is not serious enough to warrant additional matching networks.

Care should be taken when other types of coax are considered, especially if one is unfamiliar with them. For example, RG-111/U, which has an impedance of 95 ohms, might sound like a good one to use, but since it is a twin cable, it would be unsuitable.

**Gamma-Match Tune-up Procedure**

Once the antenna is constructed, a single Yagi section at a time may be initially tuned and matched. The procedures used at vhf are similar to those for hf antennas, except that more care is necessary in the selection of test instruments. For example, an SWR indicator designed for hf may burn out a diode if used on vhf, since the rf pickup may be much greater with the same line dimensions. A Bird wattmeter is ideal, but if unavailable, a homemade impedance bridge or SWR indicator could be used.

The following method has proved useful in simplifying tune-up of the gamma match and antenna elements. One parameter should be kept fixed, while the rest of the adjustments are made, rather than varying all of them simultaneously. It was found convenient to use the length of the

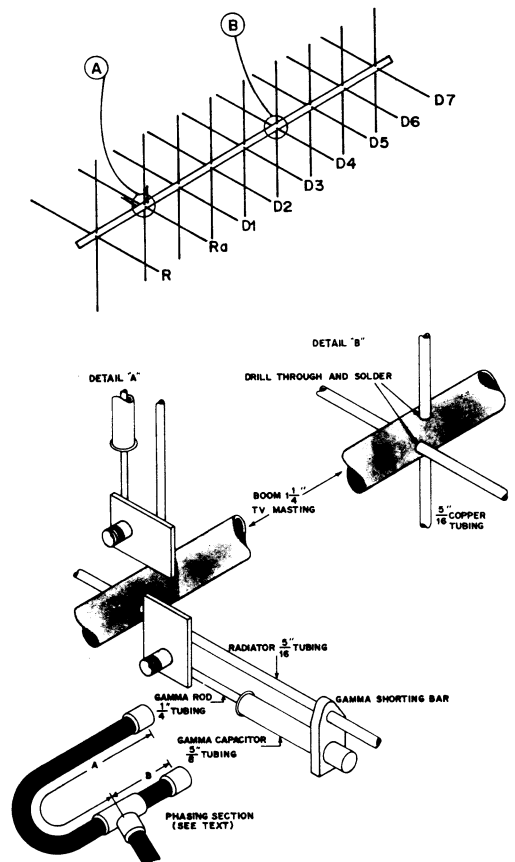

Fig. 12-3 — Construction details of a crossed Yagi antenna.

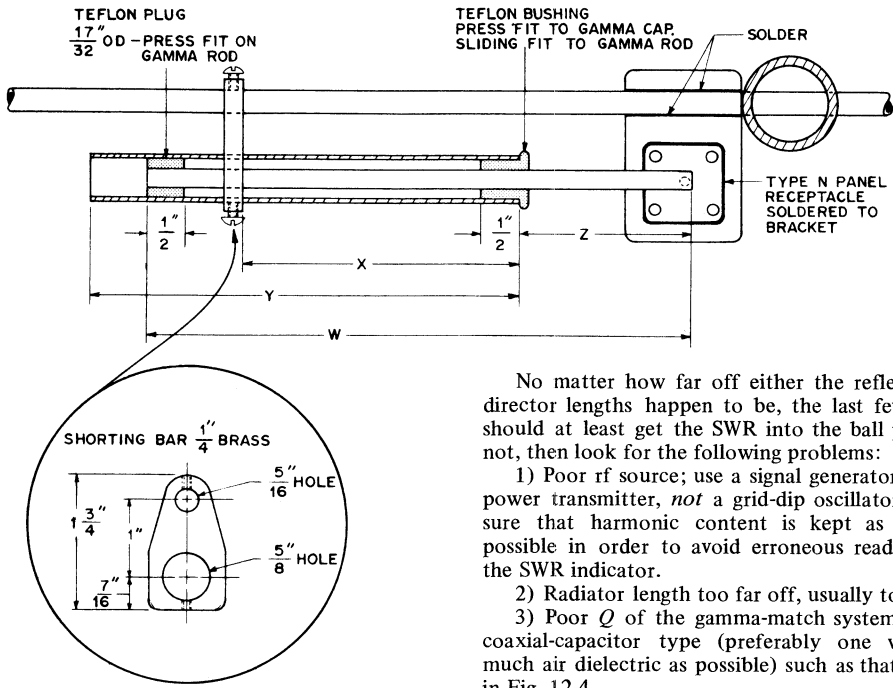

Fig. 12-4 – Gamma-match construction details.

driven element as the fixed parameter. Its approximate dimensions can be found in Table 12-I (along with those of the other elements), and the length should be slightly shorter than that given by the formula. Do not change the length, except for some minor pruning which will be mentioned later.

Once the antenna is assembled, the next step is to adjust the gamma rod and capacitor for minimum SWR. Table 12-II shows some approximate settings and lengths for the gamma rod, capacitor, and shorting bar (see Fig. 12-4). The correct procedure in tuning is to select an appropriate length for the gamma rod and capacitor sections from the table, and then adjust the shorting bar and capacitor for a minimum SWR indication, with the capacitor adjusted last.

No matter how far off either the reflector or director lengths happen to be, the last few steps should at least get the SWR into the ball park. If not, then look for the following problems:

- 1) Poor rf source; use a signal generator or low power transmitter, *not* a grid-dip oscillator. Make sure that harmonic content is kept as low as possible in order to avoid erroneous readings on the SWR indicator.
- 2) Radiator length too far off, usually too long.
- 3) Poor *Q* of the gamma-match system. Use a coaxial-capacitor type (preferably one with as much air dielectric as possible) such as that shown in Fig. 12-4.

Finally, adjust the director and reflector for maximum front-to-back ratio. This can be done by looking for minimum pickup with the back of the beam aligned with a test dipole as far away as practical. Final touch-up of the SWR can be accomplished by adjusting the length of the radiator, but by no more than one percent.

Unequal antenna currents can be equalized by offsetting the gamma section in the direction of the desired increase in antenna current, as shown in Figs. 12-1 and 12-3.

**Final Tune-up**

The procedure for tuning up a crossed Yagi is similar to that used for a single one with the following additional steps.

- 1) Attach the phasing harness through a T connector, as shown in Fig. 12-3, to the antennas and feed line. Test for SWR and make any minor adjustments necessary in order to assure a minimum reflected reading.
- 2) Test for balance and circularity as described in the following paragraphs.

In a properly adjusted antenna system, equal rf voltages should appear on all of the elements. A practical method is to see how much detuning results from attaching a short piece of wire with an alligator clip to the ends of each element. A properly balanced element will show the same amount of detuning (SWR goes up or bridge null is upset) regardless of which end has the clip.

To test for coupling between the Yagi sections (there should be none), feed power into the horizontal Yagi alone, and see how much detuning results by attaching the wire-and-clip combination to the vertical Yagi. Repeat this procedure for each

<b>TABLE 12-I</b>	
<b>Crossed Yagi antenna element lengths and spacings.</b>	
Radiator length (Ra) in feet is given by:	$Ra = 460/f \text{ (MHz)}$
Reflector length (R) equals:	$Ra + 0.1 Ra$
First director length (D1) is given by:	$Ra - .05 Ra$
Successive director lengths (D2...Dn) equal:	$D2 = D1 - .01 D1$
$Dn = (Dn - 1) - .01 (Dn - 1)$	
Spacing between reflector and radiator –	$0.2\lambda$
Spacings between first director, radiator, and	$0.15\lambda$
between all other directors –	$0.15\lambda$

TABLE 12-II				
Approximate gamma-match dimensions.				
Frequency (MHz)	Dimensions in inches (Fig. 12-4)			
	W	X	Y	Z
135.6 (ATS-1 out)	6	4	6	1
146 (OSCAR 6 in)	5-3/4	3-3/4	5	1-1/2
149.2 (ATS-1 in)	5-1/2	3-1/2	4-3/4	2

element. If there are no interactions, feed power into the vertical Yagi and see if there is any coupling from the horizontal one. In making any of these tests, while near the antenna, make sure that the power is off to avoid possible injury!

As a final test, tune in on a linearly polarized signal from a satellite such as the ATS-1, or even a repeater. Rotate the crossed Yagi on its axis and note if there is any signal variation. A good circularly polarized antenna should have no more than 1 dB variation, as one rotates the antenna.

**AN AZ-EL MOUNT FOR CROSSED YAGIS**

An important consideration when building a station for satellite work is the method of mounting and rotating the antennas. The following information by KH6IJ appeared in the June, 1973, issue of *QST*.

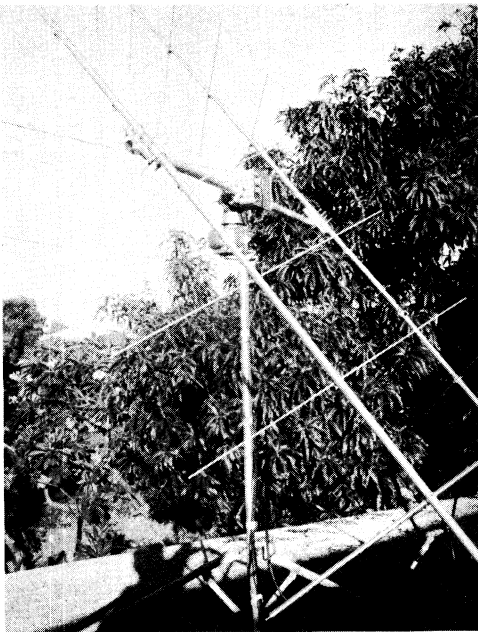

Fig. 12-5 — Two individual Yagis are mounted with the elements at 90° to each other. Elevation and azimuth movements are provided by two TV rotators.

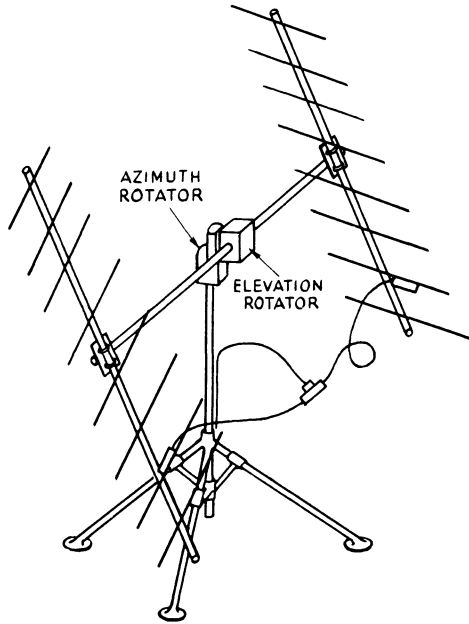

Fig. 12-6 — The antenna system can be assembled using off-the-shelf components such as Hy-Gain Yagis, Cornell-Dubilier or Blonder-Tongue rotators, and a commercially made tripod.

The basic criteria in the design of this system were low cost and ease of assembly. In the matter of choice between a crossed Yagi system and a helical antenna, the main factor was that Yagi antennas can be bought off the dealer's shelf, but most helical antennas cannot.

Figs. 12-5 and 12-6 show the overall assembly of the array. The antennas used are Hy-Gain Model 341 eight-element Yagis. Fig. 12-7 is a head-on view of the array, showing the antennas mounted at 90 degrees with respect to each other and 45 degrees with respect to the cross arm.

Coupling between the two Yagis is minimal at 90 degrees and is somewhat greater at 45 degrees. By setting the angle at 45 degrees with respect to the cross arm, coupling is minimized but not eliminated.

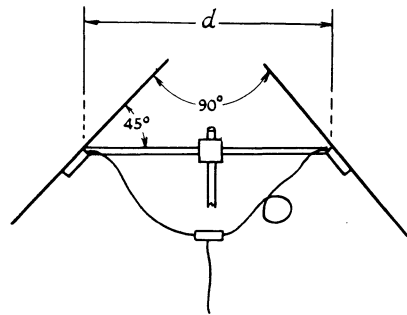

Fig. 12-7 — An end-on view of the antennas show that they are mounted at 90 degrees to each other, and at 45 degrees to the cross boom.

Length  $d$  in Fig. 12-7 should be the minimum necessary for the elements to clear the tripod base when the array is pointed straight up and rotated. In the array shown in Figs. 12-5 and 12-6, a five-foot section of TV mast serves the purpose.

### The Mounting Tripod

A mounting tripod could be made by using aluminum railing, called "NuRail," which comes with all manner of swivels, crosses, and T fittings. However, the cheapest method is to purchase a TV tower such as Lafayette No. 18-56233W, which is a collapsible tripod. It is made by the South River Metal Products Company, South River, NJ 08820. Their model number is HDT-5. This tower sells for such a low price that there is little point in constructing your own. Spread the legs of the tripod more than usual to assure greater support, but be sure that the elements of the antenna will clear the base in the straight-up position.

### Elevation-Azimuth Rotators

The azimuth rotator is a Cornell-Dubilier AR-20. The elevation rotator is a Blonder-Tongue Prism-matic PM-2. The latter is one of the few on the market which allows the cross arm of the array to be rotated on its axis when supported at the center.

Fig. 12-8 shows the detail of the method of mounting the two rotators together. Notice that the flat portion of the AR-20 makes an ideal mounting surface for the PM-2. If you want to utilize commercially fabricated components throughout, a mounting plate similar to that shown in Fig. 12-8B can be purchased. Blonder-Tongue

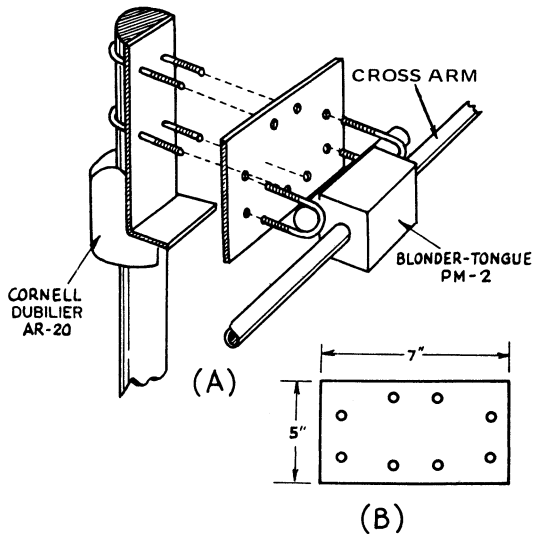

Fig. 12-8 — The method of mounting two rotators together. A pair of PM-2 rotators may also be used. The adapter plate (B) may be fabricated from 1/4-inch-thick aluminum stock, or a ready-made plate is available from Blonder-Tongue.

makes an adapter plate for their heavy-duty CATV antennas. It is called a YSB Stacking Block. The PM-2 rotator fits horizontally on this plate even though this was not the intended application. The adapter plate may be used to fasten two PM-2 rotators together.

## A TWELVE-FOOT STRESSED PARABOLIC DISH

Very few antennas evoke as much interest among uhf amateurs as the parabolic dish, and for good reason. First, the parabola and its cousins — Cassegrain, hog horn, and Gregorian — are probably the ultimate in high-gain antennas. The highest gain antenna in the world (148 dB) is a parabola. This is the 200-inch Mt. Palomar telescope. (The very short wavelength of light rays causes such a high gain to be realizable.) Second, the efficiency of the parabola does not change as it gets larger. With collinear arrays, the loss of the phasing harness increases as the size increases. The corresponding component of the parabola is lossless air between the feed horn and the reflecting surface. If there are few surface errors, the efficiency of the system stays constant regardless of antenna size.

Some amateurs reject parabolic antennas because of the belief that these are all heavy, hard to construct, have large wind-loading surfaces, and require precise surface accuracies. However, with modern construction techniques, a prudent choice of materials, and an understanding of accuracy requirements, these disadvantages can be largely overcome. A parabola may be constructed with a 0.6  $f/d$  (focal length/diameter) ratio, producing a

rather flat dish, which makes it easy to surface and allows the use of recent advances in high-efficiency feed horns. This results in greater gain for a given size of dish over conventional designs. Such an antenna is shown in Fig. 12-9. This parabolic dish is lightweight, portable, easy to build, and can be used for 432- and 1296-MHz mountaintopping, as well as on 2300, 3300, and 5600 MHz. Disassembled, it fits into the trunk of a car, and it can be reassembled in 45 minutes' time.

The usually heavy structure which supports the surface of most parabolic dish antennas has been replaced in this design by aluminum spokes bent into a near-parabolic shape by string. These strings serve the triple function of guying the focal point, bending the spokes, and reducing the error at the dish perimeter (as well as at the center) to zero. By contrast, in conventional designs, the dish perimeter, which has a greater surface area than the center, is furthest from the supporting center hub so it often has the greatest error. This error is pronounced when the wind blows. Here, each of the spokes is basically a cantilevered beam with end loading. The equations of beam bending predict a near-perfect parabolic curve for extremely small deflections. Unfortunately the deflections

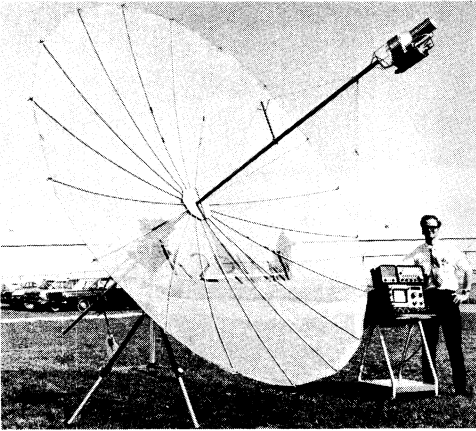

Fig. 12-9 — A stressed parabolic dish designed by K2RIW (shown at the right) set up for reception of Apollo or Skylab signals near 2280 MHz. A preamplifier is shown taped below the feed horn. From *QST*, August, 1972.

in this dish are not that small, and the loading is not perpendicular. For these reasons, mathematical prediction of the resultant curve is quite difficult. A much better solution is to measure the surface error with a template and make the necessary correction by bending each of the spokes to fit. The uncorrected surface is accurate enough for 432- and 1296 MHz use. Trophies taken by this parabola in antenna-gain contests were won using a completely natural surface with no error correction.

By placing the transmission line inside the central pipe which supports the feed horn, the area of the shadows or blockages on the reflector surface is much smaller than in other feeding and supporting systems, thus increasing gain. For 1296 MHz a backfire feed horn may be constructed to take full advantage of this feature. On 432 MHz a dipole and reflector assembly produces 1.5 dB additional gain over a corner-reflector type feed horn. Since the preamplifier is located right at the horn on 2300 MHz, a conventional feed horn may be used.

### Construction

Table 12-III is a list of materials required for construction. Care must be exercised when drilling holes in the connecting center plates so that assembly difficulty will not be experienced later. See Fig. 12-10. A notch in each plate will allow them to be assembled in the same relative position. The two plates should be clamped together and drilled at the same time. Each of the 18 half-inch-diameter aluminum spokes has two No. 28 holes drilled at its root to accept 6-32 machine screws which go through the center plates. The 6-foot-long spokes are created by cutting standard 12-foot lengths of tubing in half. A fixture built from a block of aluminum assures that the holes are drilled in exactly the same position in each spoke.

The front and back center plates constitute an I-beam-like structure, which gives the dish center considerable rigidity. Fig. 12-11 shows a side view of the complete antenna. Aluminum alloy (6061-T6) is used for the spokes, while 2024-T3 aluminum alloy sheet, 1/8 inch thick, serves for the center plates. Aluminum has approximately three times the strength-to-weight ratio of wood used in other designs. Additionally, aluminum does not become water-logged or warped. The end of each of the 18 spokes has an eyebolt facing the dish focus point which serves a double purpose: to accept the No. 9 galvanized fence wire which is routed through the screw eyes to define the dish perimeter, and to facilitate rapid assembly by accepting the S hooks which are tied to the end of each of the lengths of 130-pound test Dacron fishing string. The string bends the spokes into a parabolic curve; the dish may be adapted for many focal lengths by tightening the strings. Dacron was chosen because it has the same chemical formula as Mylar. This is a low-stretch material which keeps the dish from changing shape. The galvanized perimeter wire has a five-inch overlap area which is bound together with baling wire after the spokes have been hooked to the strings.

The aluminum window screening is bent over the perimeter wire to hold it in place on the back of the spokes. It was thought originally that the spokes in front of the screening might cause surface perturbations and decrease the gain. However, the total spoke area is small. Placing the aluminum screening in front of the spokes requires the use of 200 pieces of baling wire to hold the screening in place. This procedure increases the assembly time by at least an hour. For contest and mountaintop operating (when the screening is on the back of the spokes) no other fastening technique is required than bending the screen overlap around the wire perimeter.

TABLE 12-III

### Materials List for the 12-foot Dish

1. Aluminum tubing, 12-foot  $\times$  1/2-inch OD  $\times$  .049-inch wall, 6061-T6 alloy, 9 required to make 18 spokes.
2. Octagonal mounting plates 12  $\times$  12  $\times$  1/8 inches, 2024-T3 alloy, 2 required.
3. 1-1/4-inch ID pipe flange with setscrews.
4. 1-1/4 inches  $\times$  8 feet, TV mast tubing, 2 required.
5. Aluminum window screening, 4  $\times$  50 feet.
6. 130-pound test Dacron trolling line (available from Finney Sports, 2910 Glansman Rd., Toledo, OH 43614.)
7. 38 feet of No. 9 galvanized fence wire (perimeter), Montgomery Ward Farm and Garden Catalog.
8. Two hose clamps, 1-1/2 inch; two U bolts; 1/2  $\times$  14-inch Bakelite rod or dowel; water-pipe grounding clamp; 18 eye bolts; 18 S hooks.

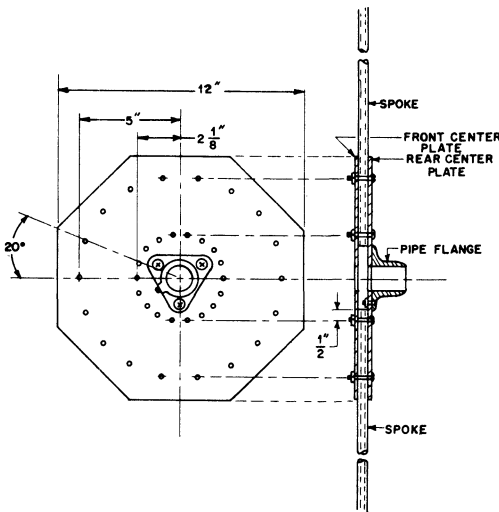

Fig. 12-10 - Center plate details. Two center plates are bolted together to hold the spokes in place.

### Surface

A four-foot-wide roll of aluminum screening 50 feet long is cut into appropriate lengths and laid parallel with a 3-inch overlap between the top of the unbent spokes and hub assembly. The overlap seams are sewn together on one half of the dish using heavy Dacron thread and a sailmaker's curved needle. Every seam is sewn twice, once on each edge of the overlapped area. The seams on the other half are left open to accommodate the increased overlap which occurs when the spokes are bent into a parabola. The perimeter of the screening then is trimmed. Notches are cut in the three-inch overlap to accept the screw eyes and S hooks. The first time this dish was assembled, the screening strips were anchored to the inside surface of the dish and the seams sewn in this position. It is easier to fabricate the surface by placing the screen on the back of the dish frame with the structure inverted. The spokes are sufficiently strong to support the complete weight of the dish when the perimeter is resting on the ground.

The 4-foot wide strips of aluminum screening conform to the compound bend of the parabolic shape very easily. If the seams are placed parallel to the *E*-field polarization of the feed horn, minimum feedthrough will occur. This feedthrough, even if the seams are placed perpendicular to the *E*-field, is so small that it is negligible. Some constructors may be tempted to cut the screening into pie-shaped sections. This procedure will increase the seam area and construction time considerably. The dish surface appears most pleasing from the front when the screening perimeter is slipped between the spokes and the perimeter wire, and is then folded back over the perimeter wire. When disassembly is desired, the screening is removed in one piece, folded in half, and rolled.

### The Horn and Support Structure

The feed horn is supported by the 1-1/4-inch aluminum television mast. The transmission line which is inserted into this tubing is connected first to the front of the feed horn which then slides back into the tubing for support. A setscrew assures that no further movement of the feed horn occurs. During antenna-gain competition the setscrew is omitted, allowing the 1/2-inch semirigid (CATV cable) transmission line to move in or out while adjusting the focal length for maximum gain. The TV mast is held firmly at the center plates by two setscrews attached to the pipe flange which is mounted on the rear plate. On 2300 MHz the dish is focused for best gain by loosening these setscrews on the pipe flange and sliding the dish along the TV mast tubing (the dish is moved instead of the feed horn).

All of the fishing strings are held in position by attaching them to a hose clamp which is permanently connected to the TV tubing. A piece of rubber sheet under the hose clamp prevents slippage and keeps the hose clamp from cutting the fishing string. A second hose clamp is mounted below the first as double protection against slippage.

The high-efficiency 1296-MHz dual-mode feed horn, detailed in Fig. 12-12, weighs 5-3/4 pounds. This weight causes some bending of the mast tubing; however this is corrected by a 1/2-inch-diameter Bakelite support. It is mounted to a pipe grounding clamp with an 8-32 screw inserted in the end of the rod. The Bakelite rod and grounding clamp are mounted midway between the hose clamp and the center plates on the mast. A double run of fishing string slipped over the notched upper end of the Bakelite rod counteracts bending.

The success of high-efficiency parabolic antennas is determined primarily by the feed-horn effectiveness. The multiple diameter of this feed horn may seem unusual. This newly designed and patented dual-mode feed, by Dick Turrin, W2IMU, achieves efficiency by launching two different kinds of waveguide modes simultaneously, which causes the dish illumination to be more constant

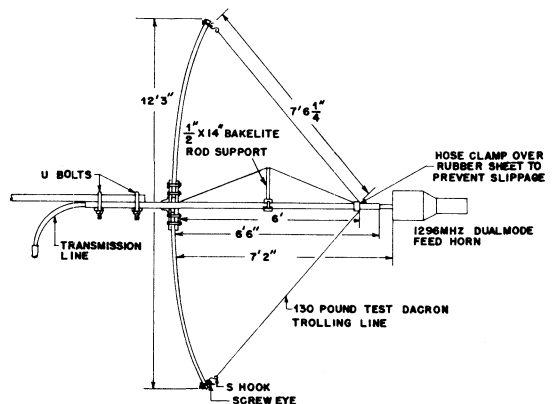

Fig. 12-11 - Side view of the stressed parabolic dish.



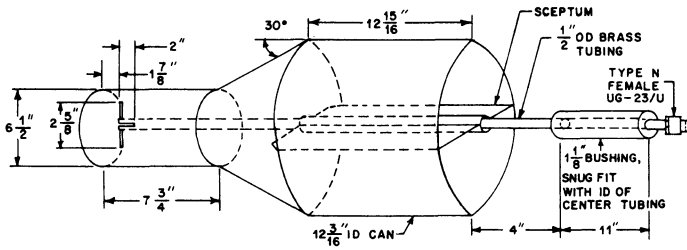

Fig. 12-12 — Backfire type 1296-MHz feed horn, linear polarization only. The small can is a Quaker State oil container; the large can is a 50-pound shortening container (obtained from a restaurant, "Gold Crisp" brand). Brass tubing, 1/2-inch OD, extends from UG-23/U connector to dipole. Center conductor and dielectric are obtained from 3/8-inch Alumaflex coaxial cable. The dipole is made from 3/32-inch copper rod. The szeptum and 30-degree section are made from galvanized sheet metal. Styrofoam is used to hold the szeptum in position. The primary gain is 12.2 dB over isotropic.

than conventional designs. The illumination drops off rapidly at the perimeter, reducing spillover. The feedback lobes are reduced by at least 35 dB because the current at the feed perimeter is almost zero; the phase center of the feed system stays constant across the angles of the dish reflector. The larger diameter section is a phase corrector and should not be changed in length. Theory predicts that almost no increase in dish efficiency can be achieved without increasing the feed size in a way that would increase complexity, as well as blockage. The feed is optimized for a  $0.6 f/d$  dish. The dimensions of the feeds are slightly modified from the original design in order to accommodate the cans. Either feed type can be constructed for other frequencies by changing the scale of all dimensions.

#### Multiband Use

Many amateurs construct multiple-band antennas by putting two dishes back to back on the same tower. This is inefficient. The parabolic reflector is a completely frequency-independent surface and studies have shown that a  $0.6 f/d$  surface can be steered seven beamwidths by moving only the feed horn from side to side before the gain diminishes one dB. Therefore, the best dual-band antenna can be built by mounting separate horns side by side. At worst the antenna may have to be moved a few degrees (usually less than a beamwidth) when switching between horns, and the unused horn increases the shadow area slightly. In fact, the same surface can function simultaneously on two frequencies, making cross-band operation possible with the same dish.

#### Assembly Order

1) A single spoke is held upright behind the rear center plate with the screw eye facing forward. Two 6-32 machine screws are pushed through the holes in the rear center plate, through the two holes of the spoke, and into the corresponding holes of the front center plate. Lock washers and nuts are placed on the machine screws and hand tightened.

2) The remaining spokes are placed between the machine screw holes. Make sure that each screw

eye faces forward. Machine screws, lock washers, and nuts are used to mount all 18 spokes.

3) The 6-32 nuts are tightened using a nut driver.

4) The mast tubing is attached to the spoke assembly, positioned properly, and locked down with the setscrews on the pipe flange at the rear center plate. The S hooks of the 18 Dacron strings are attached to the screw eyes of the spokes.

5) The ends of two pieces of fishing string (which go over the Bakelite rod support) are tied to a screw eye at the forward center plate.

6) The dish is laid on the ground in an upright position and No. 9 gauge galvanized wire is threaded through the eyebolts. The overlapping ends are lashed together with bailing wire.

7) The dish is placed on the ground in an inverted position with the focus downward. The screening is placed on the back of the dish and the screening perimeter is fastened as previously described.

8) The extension mast tubing (with counterweight) is connected to the center plate with U bolts.

9) The dish is mounted on a support (if one is used) and the transmission line is routed through the tubing and attached to the horn.

#### Parabola Gain Versus Errors

"How accurate must a parabolic surface be?" is a frequently asked question. According to the Rayleigh limit for telescopes, little gain increase is realized by making the mirror accuracy greater than  $\pm 1/8$  wavelength peak error. John Ruze of the M.I.T. Lincoln Laboratory, among others, has derived an equation for parabolic antennas and built models to prove it. The tests show that the tolerance loss can be predicted within a fraction of a dB, and less than 1 dB of gain is sacrificed with a surface error of  $\pm 1/8$  wavelength. An eighth of a wavelength is 3.4 inches at 432 MHz, 1.1 inches at 1296 MHz and 0.64 inch at 2300 MHz.

Some confusion about requirements of greater than  $1/8$ -wavelength accuracy may be the result of technical literature describing highly accurate surfaces for reasons of low side-lobe levels. We are concerned more with forward gain than with low

side-lobe levels; therefore, these stringent requirements do not apply. When a template is held up against a surface, positive and negative ( $\pm$ ) peak errors can be measured. The graphs of dish-accuracy requirements are frequently plotted in terms of rms error, which is a mathematically derived function much smaller than  $\pm$  peak error (typically 1/3). These small rms accuracy requirements have discouraged many constructors who confuse them with  $\pm$  peak errors.

Fig. 12-13 may be used to predict the resultant gain of various dish sizes with typical errors. There are a couple of surprises, as shown in Fig. 12-14. As the frequency is increased for a given dish, the gain increases 6 dB per octave until the tolerance errors become significant. Then gain deterioration occurs rapidly. Maximum gain is realized at the frequency where the tolerance loss is 4.3 dB. Notice that at 2304 MHz, a 24-foot dish with  $\pm$  2-inch peak errors has the same gain as a 6-foot dish with  $\pm$  1-inch peak errors. Quite startling, when it is realized that a 24-foot dish has 16 times the area of a 6-foot dish. Each time the diameter or frequency is doubled or halved, the gain changes 6 dB. Each time all the errors are halved, the frequency of maximum gain is doubled. With this information, the gain of other dish sizes with other tolerances may be predicted.

These curves are adequate to predict gain, assuming a high-efficiency feed horn is used (as described earlier) which realizes 60-percent aperture efficiency. At frequencies below 1296 MHz where the horn is large and causes considerable blockage, the curves are a little optimistic. A properly built dipole and splasher feed will have about 1.5 dB less gain when used with a 0.6  $f/d$  dish than will the dual-mode feed system described.

The worst kind of surface distortion is where the surface curve in the radial direction is not parabolic but gradually departs in a smooth manner from an exact parabola. The loss of gain can be severe because a large area is involved. If the surface is checked with a template, and if reasonable construction techniques are employed, devia-

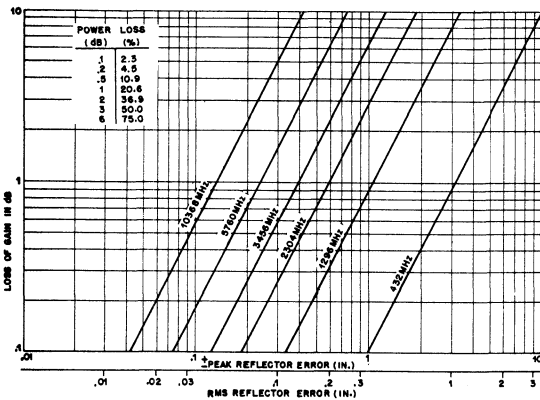

Fig. 12-13 — Gain loss vs. reflector error. Basic information obtained from J. Ruze, British IEE.

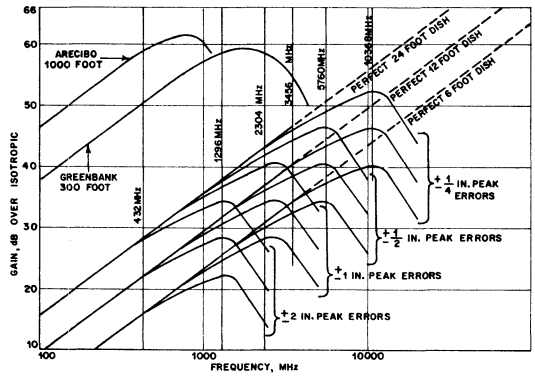

Fig. 12-14 — Parabolic-antenna gain versus size, frequency, and surface errors. All curves assume 60-percent aperture efficiency and 10-dB power taper. Reference: J. Ruze, British IEE.

tions will be under control and the curves will represent an upper limit to the gain that can be realized. If a 24-foot dish with  $\pm$ 2-inch peak errors is being used with 432-MHz and 1296-MHz multiple feed horns, the constructor might be discouraged from trying a 2300-MHz feed because there is 15 dB of gain degradation. However, the dish will have 29 dB of gain remaining on 2300 MHz, making it worthy of consideration.

The near-field range of the 12-foot 3-inch antenna is 703 feet at 2300 MHz. By using the sun as a transmitter and observing receiver noise power, it was discovered that the antenna had two main lobes about 4 degrees apart. The template showed a surface error (insufficient spoke bending at 3/4 radius), and a correction was made. A recheck showed one main lobe, and the sun noise was almost 3 dB stronger.

### Other Surfacing Materials

The choice of surface materials is a compromise between rf reflecting properties and wind loading. Aluminum screening, with its very fine mesh (and weighing 4.3 pounds per 100 square feet) is useful beyond X-band because of its very close spacing. It is easy to roll up and is therefore ideal for a portable dish. However, this close spacing causes it to be a 34-percent filled aperture, which will cause the wind force at 60 miles per hour to be more than 400 pounds on this 12-foot dish. Those amateurs considering a permanent installation of this dish should look into other surfacing materials.

One-inch hexagonal chicken wire, which is an 8-percent filled aperture, is very desirable for 432-MHz operation. It weighs 10 pounds per 100 square feet and exhibits 81 pounds of force with 60-mile-per-hour winds. However, measurement on a large piece reveals 6 dB feedthrough at 1296 MHz. Therefore, on 1296 MHz, one fourth of the power will feed through the surface material, but this will cause a loss of only 1.3 dB forward gain. Since the low-wind-loading material will provide a 30-dB gain potential, it is a very good trade-off. Chicken wire is very poor material for 2300 MHz

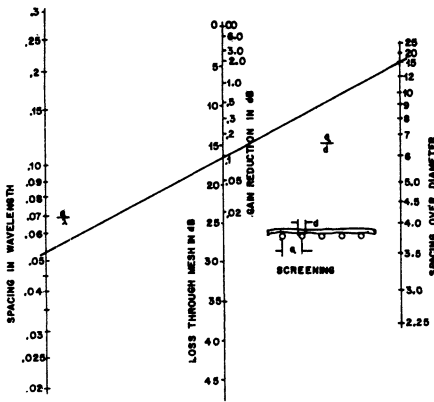

Fig. 12-15 — Surfacing material quality.

and higher, since the hole dimensions become comparable to a half wavelength. As with all surfacing materials, minimum feedthrough will occur when the *E*-field polarization is parallel to the longest dimension of the surfacing holes. Half-inch hardware cloth weighs 20 pounds per 100 square feet. It has a wind loading characteristic of 162 pounds with 60-mile-per-hour winds. The filled aperture is 16 percent and this material is useful to 2300 MHz.

A rather interesting material worthy of investigation is 1/4-inch reinforced plastic (described in Montgomery Ward Farm and Garden Catalog). It weighs only 4 pounds per 100 square feet. The plastic melts with many universal solvents such as lacquer thinner. If a careful plastic-melting job is done, what will be left is the 1/4-inch spaced aluminum wires with a small blob of plastic at each junction to hold the matrix together.

There are some general considerations to be made in selecting surfacing materials:

- 1) Joints of screening do not have to make electrical contact. The horizontal wires reflect the horizontal wave. Skew polarizations are merely a combination of horizontal and vertical components which are thus reflected by the corresponding wires of the screening. To a horizontally polarized wave, the spacing and diameter of only the horizontal wires determine the reflection coefficient (see Fig. 12-15). Many amateurs have the mistaken impression that screening materials that do not make electrical contact at their junctions are poor reflectors.
- 2) By measuring wire diameter and spacings between the wires, a calculation of percentage of aperture that is filled can be made. This will be one of the major determining factors of wind pressure when the surfacing material is dry. Under ice and snow conditions, smaller aperture materials may become clogged, which could make the surfacing material act as one solid sail. The ice and snow will have a rather minor effect on the reflecting properties of the surface, however.
- 3) Amateurs who live in areas where ice and snow are prevalent should consider a de-icing scheme such as weaving enameled wire through the

screening and passing a current through it, fastening water-pipe heating tape behind the screening, or soldering heavy leads to the screening perimeter and passing current through the screening itself.

**Parabolic Template**

For use at 2300 MHz and higher where high surface accuracy is required, a parabolic template should be constructed to measure surface errors. A simple template may be constructed (see Fig. 12-16) by taking a 12-foot 3-inch length of 4-foot wide tar paper and drawing a parabolic shape on it with chalk. The points for the parabolic shape were calculated at 6-inch intervals and these points were connected with a smooth curve. For those who wish to use the template with the surface material installed, the template should be cut along the chalk line and stiffened by cardboard or a wood lattice frame.

Surface-error measurements should take place with all spokes installed and deflected by the fishing strings, since some bending of the center plates does take place.

**A Feed System for 2287.5 MHz**

The modification of a feed horn by W2IMU, shown in Fig. 12-17, launches more accurate circularly polarized waves and has greater efficiency than conventional designs, since it eliminates the need for a hybrid coupler. It is optimized for a 0.6 *f/d* dish. When power is fed into connector No. 1 only, the 10-32 screws cause the rf to become a counterclockwise circularly polarized wave out of the horn. After bouncing off the dish this becomes a clockwise wave on either transmit or receive. Power fed into connector No. 2 becomes a ccw wave after bouncing off the dish. Therefore, for moonbounce work connect the transmitter to connector No. 1 and the receiver to connector No. 2. For Apollo reception use only connector No. 1.

The 1/4-20 screw prevents energy from coupling between connector No. 1 and connector No. 2. If the 10-32 screws are omitted, each connector

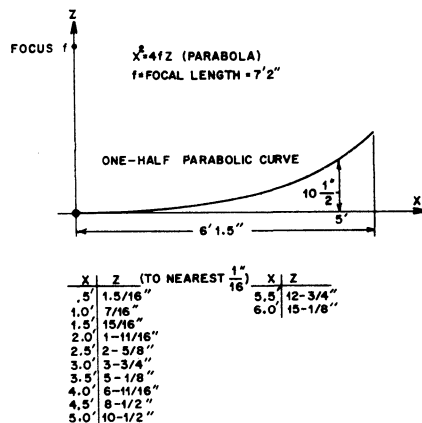

Fig. 12-16 — Parabolic template for 12-foot, 3-inch dish.

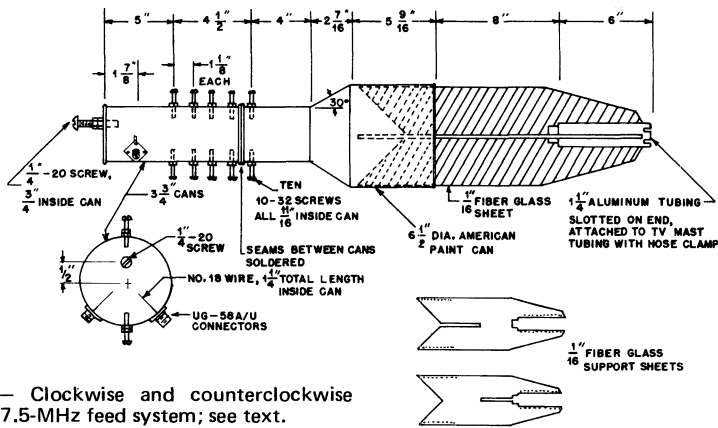

Fig. 12-17 — Clockwise and counterclockwise polarized 2287.5-MHz feed system; see text.

launches an ordinary linear wave. The small cans are "Scotts Oats" type from Scotland or "Camp" drain cleaner cans from the U.S., 3-3/4 inches ID. The large can is a one-gallon paint can, 6-1/2 inches ID. The 30-degree section is galvanized sheet metal. Tabs on each end add strength and make soldering the cans together easier.

The two UG-58A/U connectors are each fastened to the cans with two 4-40 bolts, and 4-40 nuts are soldered to the inside. The outside of the can is tinned in the area of each connector to assure good electrical contact. The ten 10-32 bolts are 1-1/4 inches long with a 11/16-inch total length inside the can. Each bolt has a 10-32 nut soldered to the outside of the can and a second 10-32 nut placed on top as a locking device. The 1/4-20 bolt is 1-1/2 inches long with 3/4 inch inside the can. Outside is a 1/4-20 nut soldered to the can and a second 1/4-20 nut added for locking purposes.

The two 1/16-inch fiber-glass mounting sheets are each slotted along half of their length, slid together at a right angle, and epoxy cemented. All cemented edges of fiber glass are first roughened with coarse sandpaper. Many very small holes are drilled into the fiber glass in the areas of metal contact.

During Apollo reception, connector No. 1 is connected to the preamplifier (if one is used) with

a short piece of cable. The preamplifier output cable runs straight to the perimeter of the dish. When no preamplifier is used, consider placing the 2287.5-MHz converter at the feed horn and running power to it. This will result in a lower system noise figure since all cables are quite lossy at 2287.5 MHz.

The inside and outside of the horn may be painted with spray lacquer for preservation. The completely painted horn had a total loss from connector No. 1 to radiated circular wave out the throat of less than 0.1 dB. With this new feed, greater than 9 dB of S-band sun noise was realized.

#### Possible Variations

The stressed parabolic antenna, as described, is a new construction technique for which a patent application has been filed. Because of its newness, all of its possibilities have not been explored. For instance, a set of fishing strings or guy wires could be set up behind the dish for error correction as long as it does not permanently bend the aluminum spokes. This technique would also protect the dish against wind loading from the rear. An extended piece of TV mast would be an ideal place to hang a counterweight and attach the back guys. It would strengthen the structure.

## HELICAL ANTENNAS

The helical antenna has suffered in popularity (but not in performance) because it is not generally well understood. With various design dimensions and construction, that corkscrew is capable of generating linear, elliptical, or circular polarization, but perhaps because of its attendant problem of matching an odd-ball feed impedance to a standard transmission line, it seems to find little acceptance in amateur circles. It is common in communication with missiles and satellites, however.

The helical antenna represents the transition point between linear-element antennas and the loop antenna. It has several modes of operation which are controlled strictly by its geometry. It

can radiate in an axial mode, along the axis of the helix, or in a broadside mode, perpendicular to the helix axis. The axial mode is that normally used at vhf and uhf. Once the basic geometry is established for axial-mode radiation, we find that other changes in the geometry can create either of the two linear polarizations, horizontal or vertical. Elliptical polarization or circular polarization can also be generated. To make the subject even more interesting, the antenna can also be of either right-hand or left-hand circularity, depending on how it is constructed.

The helix is inherently a broad-band antenna, which eliminates SWR problems over an amateur

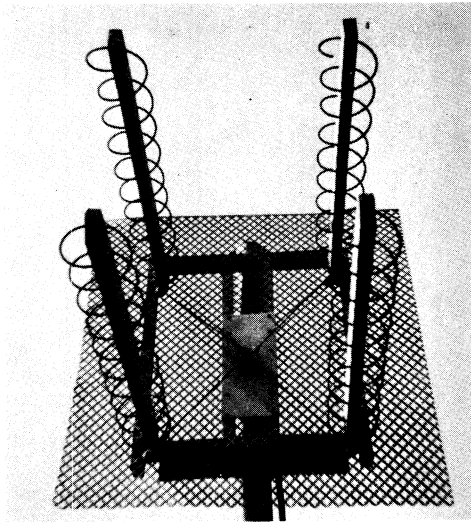

Fig. 12-18 — A front view of an early version of a quadhelix for 1296 MHz. Later versions have the elements mounted on ceramic cone insulators which are attached to the wooden booms. This procedure is strongly recommended, especially for use at 2300 MHz.

uhf band. Bandwidth is on the order of 1.7 to 1 in frequency. Expressed in terms of the helix circumference wavelength, this represents a range of from approximately 0.73 to 1.22 wavelengths. Over this range, the VSWR varies very little, remaining in the order of 1.15 to 1. Also over this range, the input impedance can be seen to vary on a Smith chart in tight curls from about 120 to 160 ohms — thus the generally quoted figure of 140 ohms. The pattern of the antenna is a well-defined lobe in both the vertical and horizontal planes over the antenna bandwidth, with pattern breakup occurring at the limits. There is a definite sharpening of the antenna pattern when the helix is used near its upper frequency limit.

The only difficult part of constructing and adjusting the helical antenna is the problem of matching the feed line to the impedance of the helix. Several articles have described one- to three-helix arrays, and have described how to build the coaxial matching section required to match the array. There is nothing wrong with the theory, but coaxial sections are tedious to build, they do fill up with moisture, and it takes considerable faith to be sure that the matching section is really  $1/4$  or  $3/4$  wavelength, or some other needed value, at these frequencies. A simple tapered line, used as the matching section, gets around this problem.

**A QUADHELIX FOR 1296 MHz**

If one helix is good, two — properly matched and phased — are approximately 3 dB better. Four helices are another 3 dB better yet — and are easy to match by the method described.

**Construction**

The quadhelix shown in Fig. 12-18 consists of four ten-turn helices formed from No. 10 AWG copper house wire from which the insulation has been stripped. Construction details are shown in Figs. 12-19 and 12-20. The helices are mounted on booms made from 1 × 2-inch smooth lumber. These booms are attached with wood screws and wood glue to a frame made from the same size lumber. The wooden portion should be painted or stained as a weather preservative. Fastened to the top and bottom of the frame are two 8-inch pieces of 1 × 1-inch angle iron from your favorite hardware store. These angle-iron pieces are drilled to accommodate the U bolts, which are used to fasten this antenna to the mast.

The sheet reflector is made from perforated aluminum. This also forms the ground plane for the matching lines. From the photograph it can be seen that a small piece of sheet aluminum was used to stiffen the ground plane at its center, where the coax connector is attached. Mounted on the antenna side of the ground plane are tapered lines, which make up the matching section. These lines are connected together at the coax feed point, and the other ends provide the feed to the individual helices. The tapered lines are of such a geometry as to transfer the approximately 140-ohm impedance of the helices to a 200-ohm point at the coaxial fitting. Strapping all four of the 200-ohm points together provides the 50-ohm feed point required

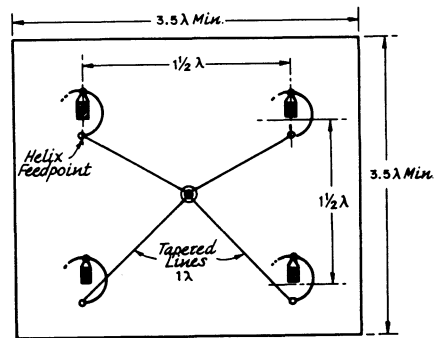
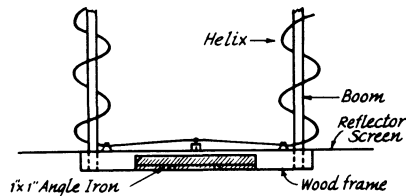

Fig. 12-19 — Top and front views of the quadhelix array. The feed lines from the individual helices terminate at the center of the array. The common meeting point for these lines is at the center conductor of a short extension of coaxial cable. This extension should be of the same impedance as the cable used to feed the array.

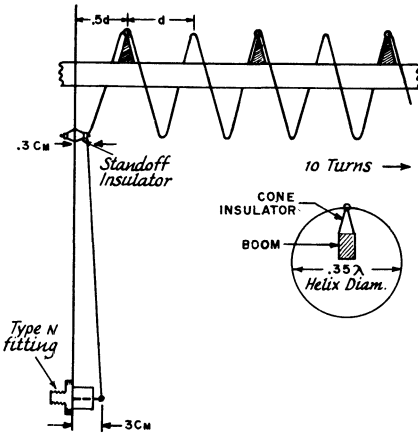

Fig. 12-20 — The method of feeding one of the four helices in the array. The feed-line extension is a short piece of copper pipe or tubing. The diameter ratio to the center conductor should be such that this extension is of the same impedance as the transmission line to the station. The height of the extension is not frequency dependent but rather is adjusted to provide a match when paralleling four helices. The slope of the line from the coax extension to the feedpoint of the individual antenna is also important in obtaining a match. See Table 12-IV for value of  $d$ .

for RG-8, -9, -14, or -17 coaxial cable. The tapered lines are also made from No. 10 AWG wire.

If you desire to vary the impedance ratios because of a different feed-line impedance, the following calculation is typical. For a single wire near a ground

$$Z_o = 138 \log_{10} \frac{4h}{d}$$

where  $h$  is the height to the conductor center, and  $d$  is the wire diameter. In order to reduce any interaction of the fields between the helices and the tapered phasing lines, it is important to keep the tapered lines as close to the ground plane as practical. This condition can be met by using No. 10 wire for the tapered lines. The diameter of this size wire is 0.1019 inch. Then, assuming that the impedance at a helix feed point is 138 ohms,

$$\log_{10} \frac{4h}{d} = \frac{138}{138} = 1$$

$$\frac{4h}{d} = 10$$

$$h = \frac{10 \times 0.1019}{4} = 0.255 \text{ in.}$$

This is the height at the feed-point end of each

helix. At the coax end where the four tapered lines join,

$$\log_{10} \frac{4h}{d} = \frac{200}{138} = 1.45$$

$$\frac{4h}{d} = 28.2$$

$$h = \frac{28.2 \times 0.1019}{4} = 0.718 \text{ in.}$$

Slight discrepancies here are nearly meaningless as the VSWR is between the four tapered lines in parallel and the 52-ohm coax line. For other conditions, just substitute the appropriate numbers. The important point is to keep the matching lines as close to the ground plane as possible.

The helices are mounted (center to center) on a square whose sides are 1.5 wavelength, or 13.7 inches for 1296 MHz. The tapered lines will then be approximately one wavelength long. In any case, keep the tapered-line lengths equal. The aluminum reflector screen should be 3.5 wavelengths (minimum) on a side. The details of the individual helices are shown in Fig. 12-20. The overall layout can be seen in the photographs. Mounting of the helix turns on the wooden booms was accomplished in earlier versions by using small metal horseshoe brads. A more elegant method is to mount the turns on small standoff insulators, and recent models using this method show increased stability with respect to weather effects. Care should be taken when adjusting the position of the helix coils on the boom to assure that the pitch angle (spacing between the turns) is the same for each turn of the helix. You should visually

TABLE 12-IV

Helix Design Data

Diameter  $D = .35\lambda$ , and Circumference  $C = 1.1\lambda$ .

Pitch Angle  $\alpha = 12.5^\circ$ ; range may be from  $12^\circ$  to  $15^\circ$ .

No. of Turns = minimum of 3.

Spacing of Turns  $d = \lambda \tan \alpha$ : for  
 2300 MHz = 130 mm  $\times$  .222 = 29 mm; for  
 1296 MHz = 231 mm  $\times$  .222 = 51 mm.

1. The above figures will cause the helix to perform best for gain and pattern near its high-frequency end.

2. The pitch angle chosen will compensate for the dielectric constant of the boom material where the material is of good rf quality, such as dry wood, PVC, Plexiglas, etc.

3. Helix will operate axially over a freq. range of 1.7 to 1.0 from a design center where  $C_\lambda = 1.0$ .

check to be sure that the helix circumference remains constant along the helix axis.

One very important consideration when building the helices is to make some provision for keeping the conductivity of the driven-element material high. The current is quite high in some portions of the helix, and losses there will degrade the performance severely. Copper is recommended and it should be cleaned very thoroughly and sprayed with a preservative such as Krylon. To really ensure long-time performance a coating of silver will be a good investment.

In recent years, bargain prices for 75-ohm cable have led to a modification of the original feed and matching dimensions. These are indicated in Fig. 12-20. The quadhelix is also beginning to show up in 2300-MHz circles. The reader interested in building one for that band need only apply the correct numbers to the formulas for determining pitch angle and diameter. The feed-point modifications are not frequency dependent.

### Bibliography

Source material and more extended discussion of topics covered in this chapter can be found in the references given below.

- DeMaw, "The Basic Helical Beam," *QST*, November, 1965.
- Knadle, "A Twelve-Foot Stressed Parabolic Dish," *QST*, August, 1972.
- McKnight, "Evolution of an Amateur Weather-Satellite Picture Station," *QST*, April, 1968, and Feedback, *QST*, July, 1968, p. 67.
- Nose, "Crossed Yagi Antennas for Circular Polarization," *QST*, January, 1973.
- Nose, "A Simple Az-El Antenna System for Oscar," *QST*, June, 1973.
- Scott and Banta, "Using the Helical Antenna at 1215 Mc.," *QST*, July, 1962.
- Troetschel, "A Quadhelix Antenna for the 1215-Mc. Band," *QST*, August, 1963.

# Construction of Wire Antennas

Although wire antennas are relatively simple, they can constitute a potential hazard unless properly constructed. Antennas should *never* be

run under or over public-utility (telephone or power) lines. Several amateurs have lost their lives by failing to observe this precaution.

## ANTENNA MATERIALS

### ANTENNA WIRE

The rf resistance of copper wire increases as the size of the wire decreases. However, in most types of antennas that are commonly constructed of wire, the rf resistance, even for quite small sizes of wire, will not be so high, compared to the radiation resistance, that the efficiency of the antenna will suffer greatly. Wire sizes as small as No. 30, or even smaller, have been used quite successfully in the construction of "invisible" antennas in areas where there is local objection to the erection of more conventional types. In most cases, the selection of wire for an antenna will be based primarily on the physical properties of the wire, since the suspension of wire from elevated supports places a strain on the wire.♦

#### Wire Types

Wire having an enamel-type coating is preferable to bare wire, since the coating resists oxidation and corrosion. Several types of wire having this type of coating are available, depending on the strength needed. "Soft-drawn" or annealed copper wire is easiest to handle but, unfortunately, is subject to considerable stretch under stress. It should therefore be avoided, except for applications where the wire will be under little or no tension, or where some change in length can be tolerated. (For instance, the length of a horizontal antenna fed at the center with open-wire line is not

♦ The National Electric Code of the National Fire Protection Association contains a section on amateur stations in which a number of recommendations are made concerning minimum size of antenna wire and the manner of bringing the transmission line into the station. The code in itself does not have the force of law, but it is frequently made a part of local building regulations, which are enforceable. The provisions of the code may also be written into, or referred to, in fire and liability insurance documents. A copy of this code may be obtained from National Fire Protection Association, 60 Batterymarch St., Boston, MA 02110. (Price \$3.50.)

critical, although a change in length may require some readjustment of coupling to the transmitter.)

"Hard-drawn" copper wire or copper-clad steel, especially the latter, is harder to handle, because it has a tendency to spiral when it is unrolled. However, these types are mandatory for applications where significant stretch cannot be tolerated. Care should be exercised in using this wire to make sure that kinks do not develop that may cause the wire to break at far under normal stress. After the coil has been unwound, it is advisable to suspend the wire a few feet above ground for a day or two before making use of it. The wire should not be recoiled before installing.

The size of the wire to be selected, and the choice between hard-drawn and copper-clad, will depend on the length of the unsupported span, the amount of sag that can be tolerated, the stability of the supports under wind pressure, and whether or not an unsupported transmission line is to be suspended from the span.

#### Wire Tension

Table 13-I shows the maximum rated working tensions of hard-drawn and copper-clad steel wire of various sizes.

If the tension on a wire can be adjusted to a known value, the expected sag of the wire, as

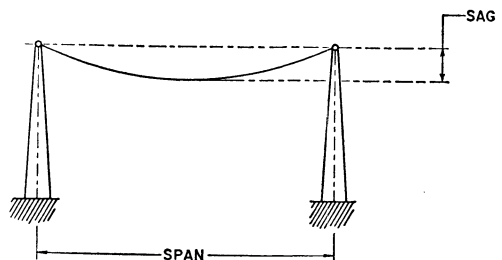

Fig. 13-1 — The span and sag of a long-wire antenna.



**TABLE 13-1**  
**Stressed Antenna Wire**

American Wire Gauge	Recommended Tension <sup>1</sup> (Pounds)		Weight (Pounds per 1000 Feet)	
	Copper-Clad Steel <sup>2</sup>	Hard-Drawn Copper	Copper-Clad Steel <sup>2</sup>	Hard-Drawn Copper
4	495	214	115.8	126
6	310	130	72.9	79.5
8	195	84	45.5	50
10	120	52	28.8	31.4
12	75	32	18.1	19.8
14	50	20	11.4	12.4
16	31	13	7.1	7.8
18	19	8	4.5	4.9
20	12	5	2.8	3.1

<sup>1</sup> Approximately one-tenth the breaking load. Might be increased 50 per cent if end supports are firm and there is no danger of ice loading.  
<sup>2</sup> "Copperweld," 40 per cent copper.

depicted in Fig. 13-1, may be determined in advance of installation with the aid of Table 13-1 and the nomograph of Fig. 13-2. Even though there may be no convenient method of determining the tension in pounds, calculation of the expected sag for practicable working tensions is often desirable. If the calculated sag is greater than allowable it may be reduced by any one or a combination of the following:

- 1) Providing additional supports thereby decreasing the span,
- 2) Increasing the tension in the wire if less than recommended,
- 3) Decreasing the size of the wire.

Conversely, if the sag in a wire of a particular installation is measured, the tension can be determined by reversing the procedure.

**Instructions for Using the Nomograph**

- 1) From Table 13-1, find the weight (pounds/1000 feet) for the particular wire size and material to be used.
- 2) Draw a line from the value obtained above, plotted on the weight axis, to the desired span (feet) on the span axis, Fig. 13-2.
- 3) Choose an operating tension level (pounds) consistent with the values presented in Table 13-1 (preferably less than the recommended wire tension).
- 4) Construct a line from the tension value chosen, plotted on the tension axis, through the crossover point of the work axis and the original line constructed from Step 2, above, and continue this new line to the sag axis.
- 5) Read the sag (feet) on the sag axis.

**Example:**

Weight = 11 pounds/1000 feet.  
 Span = 210 feet.  
 Tension = 50 pounds.

**Answer:**

Sag = 4.7 feet.

Of course, these calculations do not take the weight of a feed line into account, if it is supported by the antenna wire.

**Wire Splicing**

Wire antennas should preferably be made with unbroken lengths of wire. In instances where this is not feasible, wire sections should be spliced as shown in Fig. 13-3. The enamel insulation should be removed for a distance of about 6 inches from the end of each section by scraping with a knife or rubbing with sandpaper until the copper underneath is bright. The turns of wire should be brought up tight around the standing part of the wire by twisting with broad-nose pliers.

The crevices formed by the wire should be completely filled with solder. Since most antenna soldering must be done outdoors, the ordinary

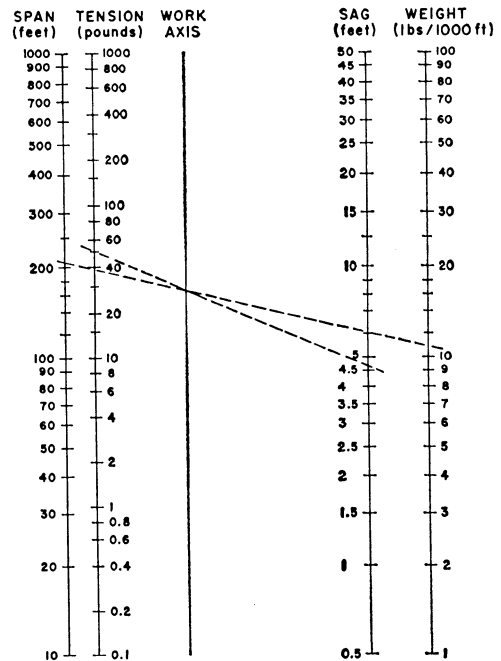

Fig. 13-2 — Nomograph for determining wire sag. (K1AFR.)

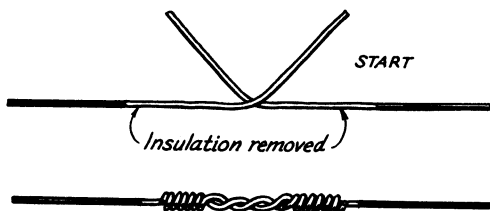

Fig. 13-3 — Correct method of splicing antenna wire.

soldering iron or gun may not provide sufficient heat, and the use of a propane torch may become desirable. The joint should be heated sufficiently so that the solder will flow freely into the joint when the source of heat is removed momentarily. After the joint has cooled completely, it should be wiped clean with a cloth, and then sprayed generously with acrylic to discourage corrosion.

## ANTENNA INSULATION

To prevent loss of power, the antenna should be well insulated from ground, particularly at the outer end or ends, since these points are always at a comparatively high rf potential. If an antenna is to be installed indoors (in an attic, for instance) the antenna may be suspended directly from the wood rafters without additional insulation, if the wood is permanently dry. However, when the antenna is located outside, where it is exposed to wet weather, much greater care should be given to the selection of proper insulators.

### Insulator Leakage

The insulators should be of material that will not absorb moisture. Most insulators designed specifically for antenna use are made of glass or glazed porcelain. Aside from this, the length of an insulator in proportion to its surface area is indicative of its comparative insulating ability. A long thin insulator will have less leakage than a short thick insulator. Some antenna insulators are deeply ribbed to increase the surface leakage path without increasing the physical length of the insulator. Shorter insulators can be used at low-potential points, such as at the center of a dipole. However, if such an antenna is to be fed with open-wire line and used on several bands, the center insulator should be the same as those used at the ends, because high rf potential will exist across the center insulator on some bands.

### Insulator Stress

As with the antenna wire, the insulator must have sufficient physical strength to sustain the

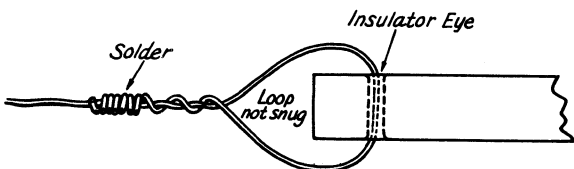

stress without danger of breakage. Long elastic bands or lengths of nylon fishing line provide long leakage paths and make satisfactory insulators within their limits to resist mechanical strain. They are often used in antennas of the "invisible" type mentioned earlier.

For low-power work with short antennas not subject to appreciable stress, almost any small glass or glazed-porcelain insulator will do. Homemade insulators of Lucite rod or sheet will also be satisfactory. More care is required in the selection of insulators for longer spans and higher transmitter power.

For the same material, the breaking tension of an insulator will be proportional to its cross-sectional area. It should be remembered, however, that the wire hole at the end of the insulator decreases the effective cross-sectional area. For this reason, insulators designed to carry heavy strains are fitted with heavy metal end caps, the eyes being formed in the metal cap, rather than in the insulating material itself. The following stress ratings of several antenna insulators made by E. F. Johnson are typical:

- 5/8 inch square by 4 inches long — 400 lbs.
- 1 inch diameter by 7 or 12 inches long — 800 lbs.
- 1-1/2 inches diameter by 8, 12 or 20 inches long, with special metal end caps — 5000 lbs.

These are rated breaking tensions. The actual working tensions should be limited to not more than 25% of the breaking rating.

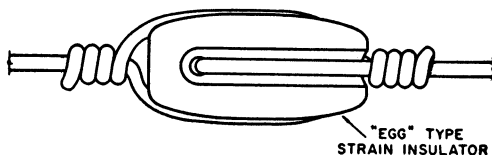

Fig. 13-5 — Conventional manner of fastening to a strain insulator. This method decreases the leakage path, and increases capacitance, as discussed in the text.

The antenna wire should be attached to the insulators as shown in Fig. 13-4. Care should be taken to avoid sharp angular bends in the wire in looping it through the insulator eye. The loop should be generous enough in size that it will not bind the end of the insulator tightly. If the length of the antenna is critical, the length should be measured to the outward end of the loop, where it passes through the eye of the insulator. The soldering should be done as described earlier for the wire splice.

Fig. 13-4 — In fastening antenna wire to an insulator, the wire loop should not be made too snug. After completion, solder should be flowed into the turns. When the joint has cooled completely, it should be sprayed with acrylic.

Strain Insulators

Strain insulators have their holes at right angles, since they are designed to be connected as shown in Fig. 13-5. It can be seen that this arrangement places the insulating material under compression, rather than tension. An insulator connected this way can withstand much greater stress. Furthermore, if the insulator should break, the wire will not collapse, since the two wire loops are interlocked. However, because the wire is wrapped around the insulator, the leakage path is reduced quite drastically, and the capacitance between the wire loops provides an additional leakage path. For this reason the use of the strain insulator is usually confined to such applications as breaking up resonances in guy wires, where high levels of stress prevail, and where the rf insulation is of less importance. Such insulators might, however, be suitable for use at low-potential points on the antenna, such as at the centers of dipoles. These insulators may also be fastened in the conventional manner if the wire will not be under sufficient tension to break the eyes out.

Insulators for Ribbon-Line Antennas

Fig. 13-6A shows the sketch of an insulator designed to be used at the ends of a folded dipole, or a multiple dipole made of ribbon line. It should be made approximately as shown, out of Lucite or bakelite about 1/4-inch thick. The advantage of this arrangement is that the strain of the antenna is shared by the conductors and the plastic webbing of the ribbon, which adds considerable strength. After soldering, the screw should be sprayed with acrylic.

Fig. 13-6B shows a similar arrangement for suspending one dipole from another in a multiple-dipole system.

If better insulation is desired, these insulators can be wired to a conventional insulator.

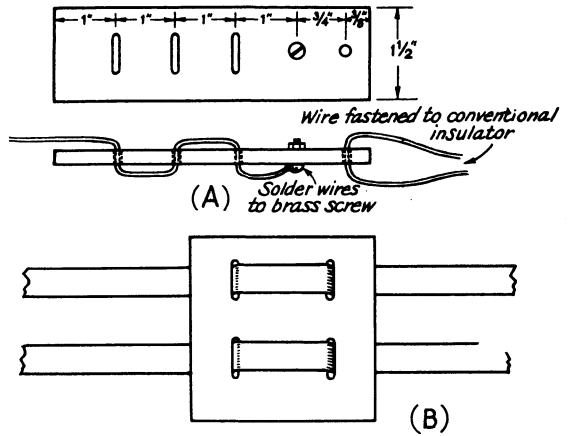

Fig. 13-6 — A — Insulator for ends of folded dipoles, or multiple dipoles made of 300-ohm ribbon. B — A method of suspending one ribbon dipole from another in a multiband dipole system.

allowing the grooved wheel to break away under tension.

Most good-quality clothesline pulleys are made of alloys which do not corrode readily. Since they are designed to carry at least 50 feet of line loaded with wet clothing in stiff winds, they should be adequate for normal spans of 100 to 150 feet between stable supports. One type of clothesline pulley has a 4-inch diameter plastic wheel with a 1/4-inch shaft in bronze bearings. The sheath is of cast or forged corrosion-proof alloy. Such pulleys sell for about one dollar in hardware stores.

Marine pulleys have good weather-resisting qualities, since they are usually made of bronze, but they are comparatively expensive and are not designed to carry heavy loads. For extremely long

PULLEYS AND HALYARDS

Pulleys and halyards commonly used to raise and lower the antenna are also items that must be capable of taking the same strain as the antenna wire and insulators. Unfortunately little specific information on the stress ratings of most pulleys is available. Several types of pulleys are readily available at almost any hardware store. Among these are small galvanized pulleys designed for awnings, and several styles and sizes of clothesline pulleys. In judging the stress that any pulley might handle, particular attention should be paid to the diameter of the shaft, how securely the shaft is fitted into the sheath, and the size and material of which the frame is made. Heavier and stronger pulleys are those used in marine work.

Another important factor to be considered in the selection of a pulley is its ability to resist corrosion. Galvanized awning pulleys are probably the most susceptible to corrosion. While the frame or sheath usually stands up well, these pulleys usually fail at the shaft, which eventually rusts out,

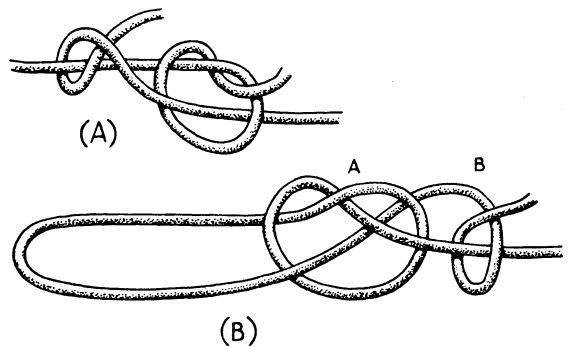

Fig. 13-7 — This is one type of knot that will hold with smooth rope, such as nylon. A shows the knot for splicing two ends. B shows the use of a similar knot in forming a loop, as might be needed for attaching an insulator to a halyard. Knot A is first formed loosely 10 or 12 inches from the end of the rope; then the end is passed through the eye of the insulator and knot A. Knot B is then formed and both knots pulled tight. (K7HDB.)

spans, the wood-sheathed pulleys used in "block and tackle" devices, and for sail hoisting should fill the requirements.

**Halyards**

Table 13-II shows recommended maximum tensions for various sizes and types of line and rope suitable for hoisting halyards. Probably the best type for general amateur use for spans up to 150 or 200 feet is 1/4-inch nylon rope. It is somewhat more expensive than ordinary rope of the same size, but it weathers much better. Furthermore, it has a certain amount of elasticity to accommodate gusts of wind, and is particularly recommended for antennas using trees as supports.

Most types of synthetic rope are slippery, and some types of knots ordinarily used for rope will not hold well. Fig. 13-7 shows a knot that should hold well, even with nylon rope or plastic line.

For exceptionally long spans, stranded galvanized steel sash cord is suitable. Cable advertised as "wire rope" usually does not weather well.

A convenience in antenna hoisting (usually a necessity with metal halyards) is the boat winch sold at marinas, and also at such places as Sears.

TABLE 13-II Approximate Safe Working Tension (lbs.) for Various Halyard Materials			
Manila Rope			
¼" - 120	⅜" - 270	½" - 530	¾" - 800
Polypropylene Rope			
¼" - 270	⅜" - 530	½" - 840	
Nylon Rope			
¼" - 300	⅜" - 660	½" - 1140	
7 x 11 Galvanized Sash Cord			
¼" - 30	⅜" - 125	½" - 250	¾" - 450
High-Strength Stranded Galvanized Guy Wire			
⅝" - 400	¾" - 700	1" - 1200	
Rayon-filled Plastic Clothesline			
⅝" - 60 to 70			

**INSTALLING TRANSMISSION LINES**

**CONNECTING LINE TO ANTENNA**

In connecting coaxial cable or 300-ohm ribbon line to a dipole that does not have a support at the center, it is essential that the conductors of the line be relieved of the weight of the cable or ribbon. Fig. 13-8 shows a method of accomplishing this with coaxial cable. The cable is looped around the center antenna insulator, and clamped before making connections to the antenna. In Fig. 13-9, the weight of the ribbon line is removed from the conductor by threading the line through a sheet of insulating material. The sheet is suspended from the antenna by threading the antenna through the sheet. This arrangement is particularly suited to folded dipoles made of 300-ohm ribbon.

In connecting an open-wire line to an antenna, the conductors of the line should be anchored to the insulator by threading them through the eyes of the insulator two or three times, and twisting the wire back on itself before soldering fast. A

slack tie wire should then be used between the feeder conductor and the antenna, as shown in Fig. 13-10. (The tie wires may be extensions of the line conductors themselves.)

When using TV-type open-wire line, the tendency of the line to twist and short out close to the antenna can be counteracted by making the center insulator of the antenna longer than the spacing of the line, as shown in Fig. 13-10. In this case, a heavier spreader insulator should be added just below the antenna insulator to prevent side stress from pulling the conductors away from the light plastic feeder spreaders.

**RUNNING LINE FROM ANTENNA TO STATION**

Coaxial cable requires no particular care in running from the antenna to the station entrance, except to protect it from mechanical damage. If

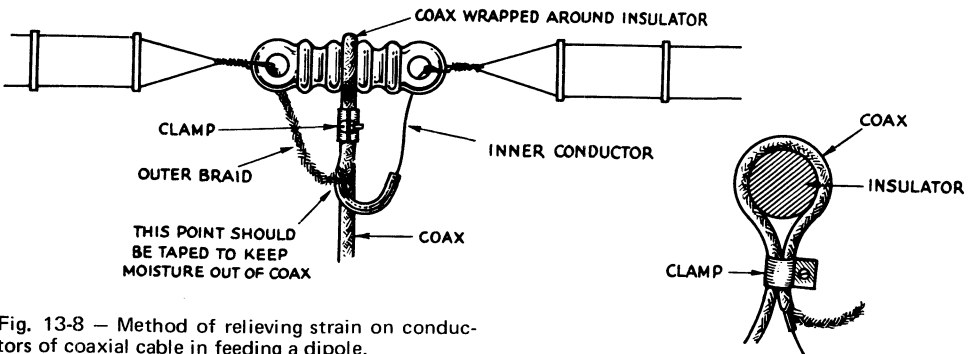

Fig. 13-8 — Method of relieving strain on conductors of coaxial cable in feeding a dipole.

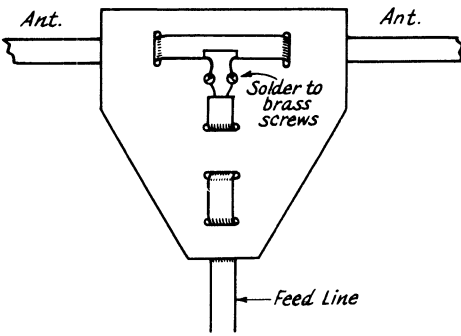

Fig. 13-9 — Strain reliever for conductors of 300-ohm ribbon line in a folded dipole. The piece can be made from 1/4-inch Lucite sheet.

the antenna is not supported at the center, the line should be fastened to a post more than head high located under the center of the antenna, allowing enough slack between the post and the antenna to take care of any movement of the antenna in the wind. If the antenna feed point is supported by a tower or mast, the cable can be taped at intervals to the mast, or to one leg of the tower.

If desired, coaxial cable can be buried a few inches in the ground in making the run from the antenna to the station. A deep slit can be cut by pushing a square-end spade full depth into the ground, and moving the handle back and forth to widen the slit before removing the spade. After the cable has been pushed into the slit with a piece of 1-inch board 3 or 4 inches wide, the slit can be closed by tamping.

Ribbon line should be kept reasonably well spaced from other conductors running parallel to it for more than a few feet. TV-type standoff insulators with strap-clamp mountings can be used in running this type of line down a mast or tower leg. Similar insulators of the screw type can be used in supporting the line on poles for a long run.

Open-wire lines, especially TV types, require frequent supports to keep the line from twisting and shorting out, as well as to relieve the strain. One method of supporting a long run of heavy open-wire line is shown in Fig. 13-11. The line must be securely anchored at a point under the feed point of the antenna. TV-type line can be supported similarly by means of wire links fastened to the insulators. Fig. 13-12 shows a method of supporting an open-wire line from a tower.

To keep the line clear of pedestrians and vehicles, it is usually desirable to anchor the feed line at the eave or rafter line of the station building (see Fig. 13-13), and then drop it vertically to the

point of entrance. The points of anchorage and entrance should be chosen so as to permit the vertical drop without crossing windows.

If the station is located in a room on the ground floor, one way of bringing coax transmission line in is to go through the outside wall below floor level, feed it through the basement, and then up to the station through a hole in the floor. In making the entrance hole in the side of the building, suitable measurements should be made in advance to make sure that the hole will go through the sill 2 or 3 inches above the foundation line (and between joists if the bore is parallel to the joists). The line should be allowed to sag below the entrance-hole level to allow rain water to drip off, and not follow the line into the building.

Open-wire line can be fed in a similar manner, although it will require a separate hole for each conductor. The hole should be insulated with

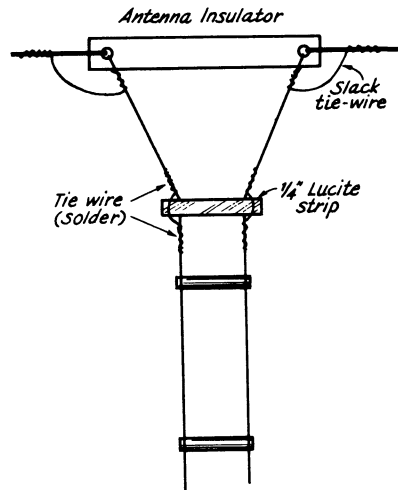
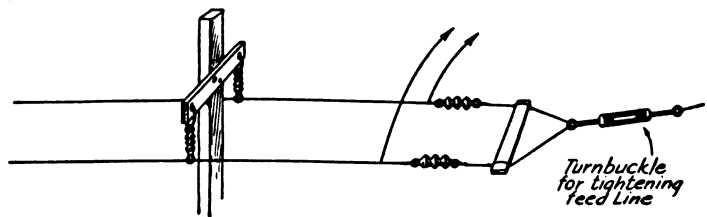

Fig. 13-10 — Method of connecting open-wire line to center antenna insulator. The Lucite strip keeps the feed-line conductors from pulling away from the spreaders when TV open-wire line is used.

lengths of polystyrene or Lucite tubing, and should be drilled with a slight downward slant toward the outside of the building to prevent rain seepage. With TV-type line, it will be necessary to remove a few of the spreader insulators, cut the line before passing through the holes (allowing enough length to reach the inside), and splice the remainder on the inside.

Fig. 13-11 — A support for open-wire line. The support at the antenna end of the line must be sufficiently rigid to stand the tension of the line.



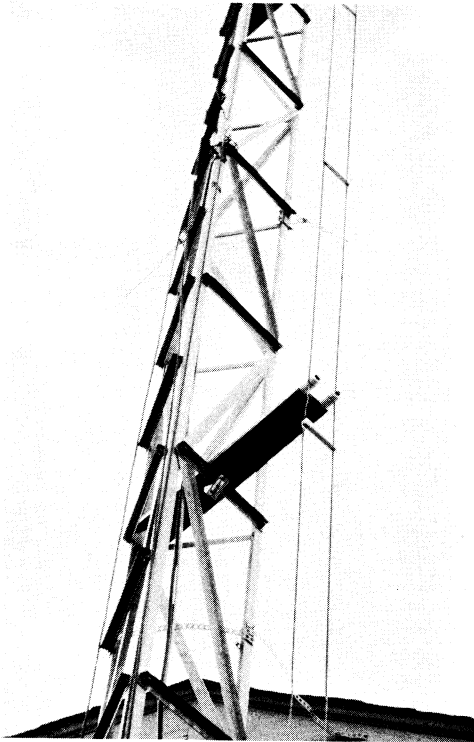

Fig. 13-12 — A board fitted with standoff insulators and clamped to the tower with U bolts keeps open-wire line suitably spaced from a tower. (W4NML.)

If the station is located above ground level, or there is other objection to the procedure described above, entrance can be made at a window, using the arrangement shown in Fig. 13-14. An Amphenol type 83-1F (UG-363/U) connector can be used as a feedthrough for coaxial line, or one can be made as shown in Fig. 13-15; ceramic feed-

through insulators can be used for open-wire line. Ribbon line can be run through clearance holes in the panel, and secured by a winding of tape on either side of the panel, or by cutting the retaining rings and insulators from a pair of TV standoff insulators, and clamping one on each side of the panel.

## LIGHTNING PROTECTION

Two or three types of lightning arresters for coaxial cable are available on the market. These are designed to join two lengths of coax cable. If the antenna feed point is at the top of a well-grounded tower, the arrester can be fastened securely to the top of the tower for grounding purposes. A short length of cable, terminated in a coaxial plug, is then run from the antenna feed point to one receptacle of the arrester, while the transmission line is run from the other arrester receptacle to the station. Such arresters may also be placed at the entrance point to the station, if a suitable ground connection is available at that point (or arresters may be placed at both points for added insurance).

The construction of a homemade arrester for open-wire line is shown in Fig. 13-16. This type of arrester can be adapted to ribbon line, as shown in Fig. 13-17. The two TV standoff insulators should elevate the ribbon line an inch or so away from the center member of the arrester. Sufficient insulation should be removed from the line where it crosses the arrester to permit soldering the arrester connecting leads.

### Lightning Grounds

Lightning-ground connecting leads should be of conductor equivalent to at least No. 10 wire. The No. 8 aluminum wire used for TV-antenna grounds is satisfactory. Copper braid 3/4-inch wide (Belden 8662-10) is also suitable. The conductor should run in a straight line to the grounding point. The ground connection may be made to a water-piping system, the grounded metal frame of a building, or to one or more 5/8-inch ground rods driven to a depth of at least 8 feet.

## SUPPORTS FOR WIRE ANTENNAS

A prime consideration in the selection of a support for an antenna is that of structural safety. Building regulations in many localities require that a permit be secured in advance of the erection of structures of certain types, often including antenna poles or towers. In general, localities having such requirements also will have building safety codes that must be observed. Such regulations may govern the method and materials used in construction of, for example, a self-supporting tower. Checking with your local government building department before putting up a tower may save a good deal of difficulty later, since a tower would have to be taken down or modified if not approved by the building inspector on safety grounds.

Municipalities have the right and duty to enforce any reasonable regulations having to do

with the safety of life or property. The courts generally have recognized, however, that municipal authority does not extend to esthetic questions; i.e., the fact that someone may object to the mere presence of a pole or tower, or an antenna structure, because in his opinion it detracts from the beauty of the neighborhood, is not grounds for refusing to issue a permit for a safe structure to be erected.

But, even where such regulations do not exist or are not enforced, the amateur should be careful to select a type of support and a location for it that will minimize the chances of collapse and, if collapse does occur, will minimize the chances that someone will be injured or property damaged. A single injury can be far more costly than the price of a more rugged support.

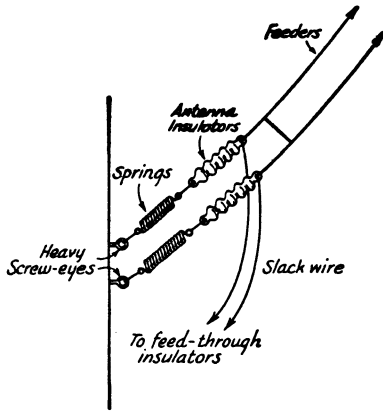

Fig. 13-13 — Anchorage for open-wire line at the station end. The springs are especially desirable if the line is not supported between the antenna and the anchoring point.

TREES AS ANTENNA SUPPORTS

From the beginning of amateur radio, trees have been used widely for supporting wire antennas. Trees cost nothing, of course, and will often provide a means of supporting a wire antenna at considerable height. However, as an antenna support, a tree is highly unstable in the presence of

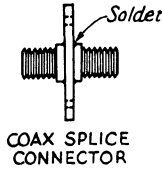

Fig. 13-15 — Feedthrough connector for coax line. An Amphenol 83-1J (PL-258) connector, the type used to splice sections of coax line together, is soldered into a hole cut in a brass mounting flange. Amphenol bulk adapter 83-1F may be used instead.

wind, unless the tree is a very large one, and the antenna is suspended from a point well down on the tree trunk. As a result, the antenna must be constructed much more sturdily than would be necessary with stable supports. Even with rugged construction, it is unlikely that an antenna suspended from a tree, or between trees, will stand up indefinitely, and occasional repair or replacement usually must be expected.

There are two general methods of securing a pulley to a tree. If the tree can be climbed safely to the desired level, a pulley can be wired to the trunk of the tree, as shown in Fig. 13-18. If, after passing the halyard through the pulley, both ends of the halyard are simply brought back down to ground along the trunk of the tree, there may be difficulty

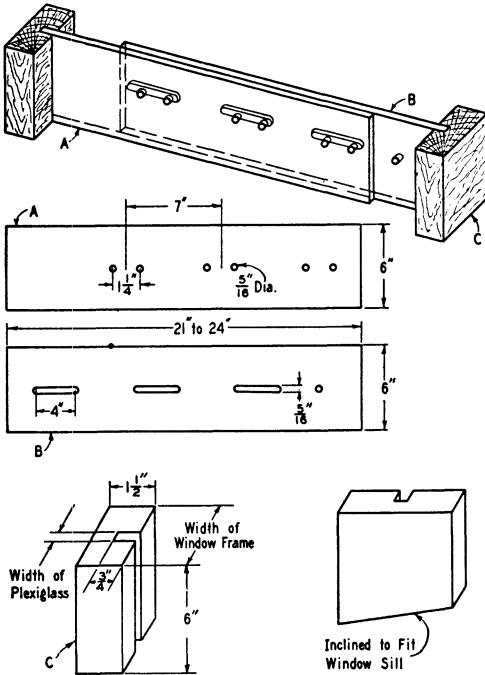

Fig. 13-14 — An adjustable window lead-in panel made of two sheets of Lucite. A feedthrough connector for coax line can be made as shown in Fig. 13-15. Ceramic feedthrough insulators are suitable for open-wire line. (W1RVE.)

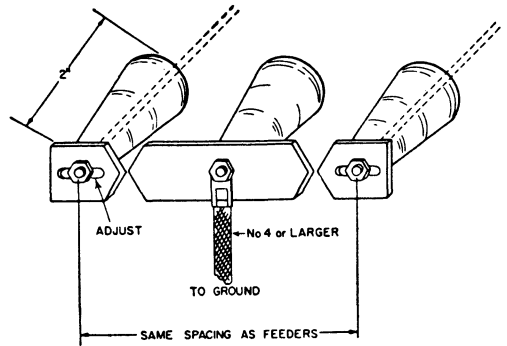

Fig. 13-16 — A simple lightning arrester for open-wire line made from three standoff or feed-through insulators and sections of 1/8 X 1/2-inch brass or copper strap. It should be installed in the line at the point where the line enters the station. The heavy ground lead should be as short and direct as possible. The gap setting should be adjusted to the minimum width that will prohibit arcing when the transmitter is operated.

in bringing the antenna end of the halyard out where it will be clear of branches. To avoid this, one end of the halyard can be tied temporarily to the tree at the pulley level, while the remainder of the halyard is coiled up, and the coil thrown out horizontally from this level, in the direction in which the antenna will run. It may help to have the antenna end of the halyard weighted. Then, after attaching the antenna to the halyard, the other end is untied from the tree, passed through the pulley, and brought to ground along the tree trunk in as straight a line as possible. The halyard need be only long enough to reach the ground after the antenna has been hauled up, since additional rope can be

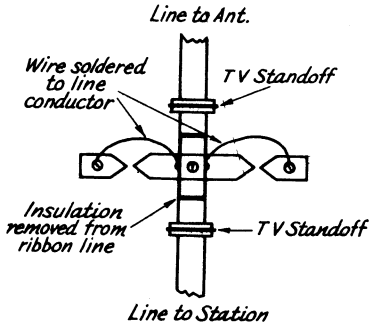

Fig. 13-17 — The lightning arrester of Fig. 13-16 may be used with 300-ohm ribbon line in the manner shown here. The TV standoffs support the line an inch or so away from the grounded center member of the arrester.

... tied to the halyard when it becomes necessary to lower the antenna.

The other method consists of passing a line over the tree from ground level, and using this line to haul a pulley up into the tree and hold it there. Several ingenious methods have been used to accomplish this. The simplest method employs a weighted pilot line, such as fishing line or mason's chalk line. Grasping the line about two feet from the weight, the weight is swung back and forth, pendulum style, and then heaved with an underhand motion in the direction of the tree top.

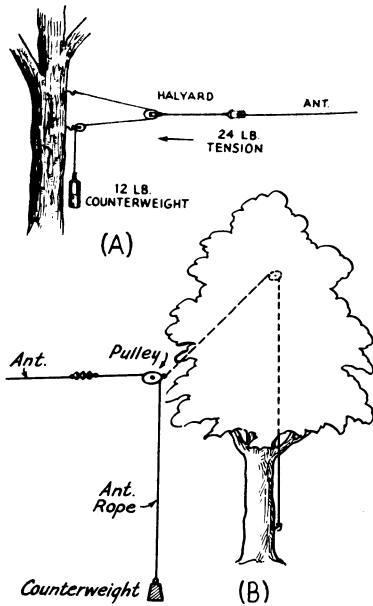

Fig. 13-18 — Methods of counterweighting to minimize antenna movement. The method at A limits the fall of the counterweight should the antenna break. It also has a 2 to 1 mechanical advantage, as indicated. The method at B has the disadvantage that the point of support in the tree must be higher than the end of the antenna.

Several trials may be necessary to determine the optimum size of the weight for the line selected, the distance between the weight and the hand before throwing, and the point in the arc of the swing where the line is released. The weight, however, must be sufficiently large to assure that it will carry the pilot line back to ground after passing over the tree. Flipping the end of the line up and down so as to put a traveling wave on the line often helps to induce the weight to drop down if the weight is marginal. The higher the tree, the lighter the weight and the pilot line must be. A glove should be worn on the throwing hand, because a line running swiftly through the bare hand can cause a severe burn.

If there is a clear line of sight between ground and a particularly desirable crotch in the tree, it may be possible to hit the crotch eventually after a sufficient number of tries. Otherwise, it is best to try to heave the pilot line completely over the tree, as close to the center line of the tree as possible. If it is necessary to retrieve the line and start over again, the line should be drawn back very slowly, otherwise the swinging weight may wrap the line around a small limb, making retrieval impossible.

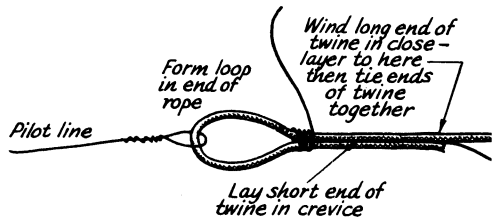

Fig. 13-19 — In connecting the halyard to the pilot line, a large knot that might snag in the crotch of a tree should be avoided, as shown.

Stretching the line out in a straight line on the ground before throwing may help to keep the line from snarling, but it places extra drag on the line, and the line may snag on obstructions overhanging the line when it is thrown. Another method is to make a stationary reel by driving eight nails, arranged in a circle, through a 1-inch board. After winding the line around the circle formed by the nails, the line should reel off readily when the weighted end of the line is thrown. The board should be tilted at approximately right angles to the path of the throw.

Other devices that have been used successfully to pass a pilot line over a tree are the bow and arrow with heavy thread tied to the arrow, and the short casting rod and spinning reel used by fishermen. Still another method that has been used where sufficient space is available is to fly a kite. After the kite has reached sufficient altitude, simply walk around the tree until the kite string lines up with the center of the tree. Then pay out string until the kite falls to the earth. This method has been used successfully to pass a line over a patch of woods between two higher supports,



which would have been impossible using any other method.

The pilot line can be used to pull successively heavier lines over the tree until one of adequate size to take the strain of the antenna has been reached. This line is then used to haul a pulley up into the tree after the antenna halyard has been threaded through the pulley. The line that holds the pulley must be capable of withstanding considerable chafing where it passes through the crotch, and at points where lower branches may rub against the standing part. For this reason, it may be advisable to use galvanized sash cord or stranded guy wire for raising the pulley.

Especially with larger sizes of line or cable, care must be taken when splicing the pilot line to the heavier line to use a splice that will minimize the chances that the splice cannot be coaxed through the tree crotch. One type of splice is shown in Fig. 13-19.

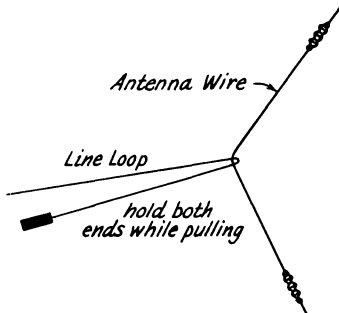

Fig. 13-20 — A weighted line thrown over the antenna can be used to pull the antenna to one side to avoid overhanging obstructions, such as branches of trees in the path of the antenna, as the antenna is pulled up. When the obstruction has been cleared, the line can be removed by releasing one end.

The crotch which the line first comes to rest in may not be sufficiently strong to stand up under the tension of the antenna. However, if the line has been passed over, or close to, the center line of the tree, it will usually break through the lighter crotches and finally come to rest in one sufficiently strong lower down on the tree.

Needless to say, any of the suggested methods should be used with due respect to persons or property in the immediate vicinity. A child's sponge-rubber ball (baseball size) makes a safe weight for heaving a heavy thread line or fishing line.

If the antenna wire becomes snagged in lower branches of the tree when the wire is pulled up, or if branches of other trees in the vicinity interfere with raising the antenna, a weighted line thrown over the antenna and slid along to the appropriate point is often helpful in pulling the antenna wire to one side to clear the interference as the antenna is being raised, as shown in Fig. 13-20.

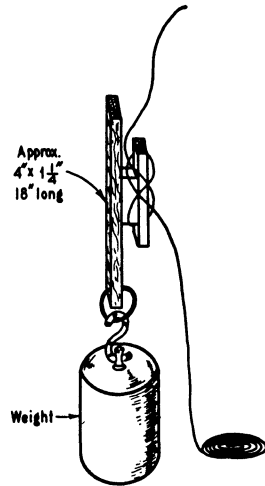

Fig. 13-21 — The cleat avoids the necessity of having to untie a knot that may have been weather-hardened.

Wind Compensation

The movement of an antenna suspended between supports that are not stable in wind can be reduced materially by the use of heavy springs, such as screen-door springs under tension, or by a counterweight at the end of one halyard, as shown in Fig. 13-18. The weight, which may be made up of junk-yard metal, window sash weights, or a galvanized pail filled with sand or stone, should be adjusted experimentally for best results under existing conditions. Fig. 13-21 shows a convenient way of fastening the counterweight to the halyard. It avoids the necessity for untying a knot in the halyard which may have hardened under tension and exposure to the weather.

Trees as Supports for Vertical Wire Antennas

Trees can often be used to support vertical as well as horizontal antennas. If the tree is a tall one with overhanging branches, the scheme of Fig. 13-22 may be used. The top end of the antenna is secured to a halyard passed over the limb, brought back to ground level, and fastened to the trunk of the tree.

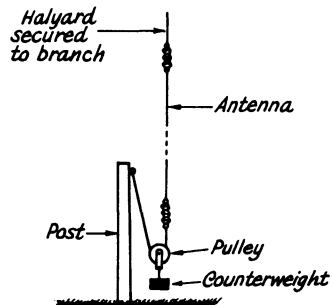

Fig. 13-22 — Counterweight for a vertical antenna suspended from an overhanging tree branch.

**MASTS**

Where suitable trees are not available, or a more stable form of support is desired, masts are suitable for wire antennas of reasonable span length. At one time, most amateur masts were constructed of lumber, but the TV industry has brought out metal masting that is inexpensive and much more durable than wood. However, there are some applications where wood is necessary or desirable.

**The "A-Frame" Mast**

A light and inexpensive mast is shown in Fig. 13-23. In lengths up to 40 feet it is very easy to erect and will stand without difficulty the pull of ordinary wire antenna systems. The lumber used is 2 x 2 straight-grained pine (which many lumber yards know as hemlock) or even fir stock. The uprights can be each as long as 22 feet (for a mast slightly over 40 feet high) and the crosspieces are cut to fit. Four pieces of 2 x 2, 22 feet long, will provide enough and to spare. The only other materials required are five 1/4-inch carriage bolts 5-1/2 inches long, a few spikes, about 300 feet of stranded or solid galvanized iron wire for the guys or stays, enough glazed-porcelain compression insulators ("eggs") to break up the guys into sections, and the usual pulley and halyard rope. If the strain insulators are put in every 20 feet, approximately 15 of them will be enough.

After selecting and purchasing the lumber — which should be straight-grained and knot-free — three sawhorses or boxes should be set up and the mast assembled in the manner indicated in Fig. 13-24. At this stage it is a good plan to give the

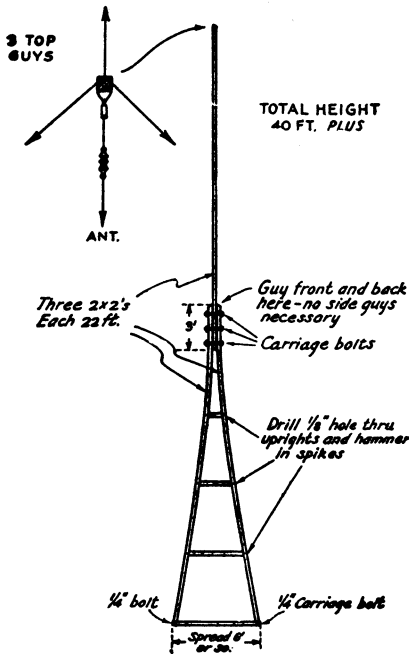

Fig. 13-23 — The "A-frame" mast, lightweight and easily constructed and erected.

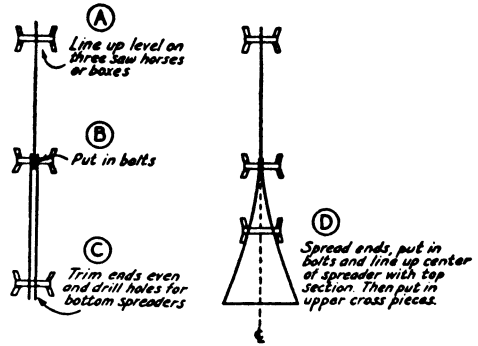

Fig. 13-24 — Method of assembling the "A-frame" mast.

mast two coats of "outside-white" house paint or latex.

After the second coat of paint is dry, attach the guys and rig the pulley for the antenna halyard. The pulley anchorage should be at the point where the top stays are attached so that the back stay will assume the greater part of the load tension. It is better to use wire wrapped around the mast with a small through-bolt to prevent sliding down, than to use eye bolts.

If the mast is to stand on the ground, a couple of stakes should be driven to keep the bottom from slipping. At this point the mast may be "walked up" by a helper. If it is to go on a roof, first stand it up against the side of the building and then hoist it, from the roof, keeping it vertical. The whole assembly is light enough for two men to perform the complete operation — lifting the mast, carrying it to its permanent berth, and fastening the guys — with the mast vertical all the while. It is therefore entirely practicable to put up this kind of mast on a small flat area of roof that would prohibit the erection of one that had to be raised to the vertical in its final location.

**TV Masting**

TV masting is available in 5- and 10-foot lengths, 1-1/4 inches in diameter, in both steel and aluminum. These sections are crimped at one end to permit sections to be joined together. However, a form that will usually be found more convenient is the telescoping TV mast available from many electronic supply houses. The masts may be obtained with three, four or five 10-foot sections, and come complete with guying rings and a means of locking the sections in place after they have been extended. These masts are stronger than the nontelelescoping type because the top section is 1-1/4 inches in diameter, and the diameter increases toward the bottom section which is 2-1/2 inches in diameter in the 50-foot mast.

Guy rings are provided at 10-foot intervals, but guys may not be required in all points. Guys at the top are essential, and at least one other set near the center of the mast will usually be found necessary to keep the mast from bowing. If the mast has any tendency to whip in the wind, or to bow under the

stress of the antenna, additional guys should be added at the obvious points.

## MAST GUYING

Three guy wires in each set will usually be adequate for a mast. These should be spaced equally around the mast. The number of sets of guys will depend on the height of the mast, its natural sturdiness, and the required antenna tension. A 30-foot mast will usually require two sets of guys, while a 50-foot mast will need at least three sets. One guy of the top set should be run in a direction directly opposite to the direction in which the antenna will run, the other two being spaced 120 degrees with respect to the first, as shown in Fig. 13-23.

The general rule is that the top guys should be anchored at distances from the base of the mast equal to not less than 60% of the height of the mast. At the 60% distance, the stress on the guy wire opposite the antenna will be approximately twice the tension on the antenna. As the distance between the guy anchorage and the base of the mast is decreased, the tension on the rear guy in proportion to the tension on the antenna rises rapidly, the extra tension resulting in additional compression on the mast, which increases the tendency for the mast to buckle.

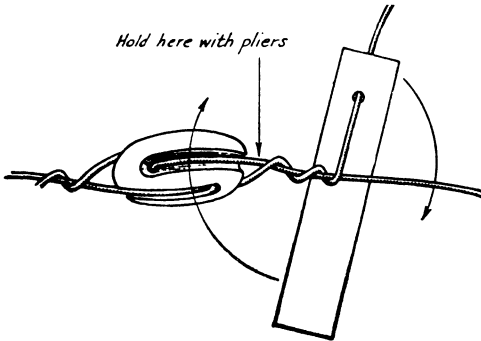

Fig. 13-25 — Simple lever for twisting solid guy wires in attaching strain insulators.

The function of additional sets of guys is to correct for any tendency that the mast may have to bow or buckle under the compression imposed by the top guys. To avoid possible mechanical resonance in the mast that might cause the mast to have a tendency to vibrate, the sets of guys should not be spaced equally on the mast. A second set of guys should be placed at approximately 60% of the distance between the ground and the top of the mast, while a third set should be placed at about 60% of the distance between the ground and the second set.

The additional set of guys should be anchored at distances from the base of the mast equal to not less than 60% of the distance between ground and the points of attachment on the mast. In practice, the same anchors are usually used for all sets of guys, which means that the latter requirement is met automatically if the top set has been anchored at the correct distance.

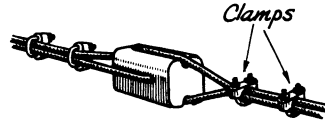

Fig. 13-26 — Stranded guy wire should be attached to strain insulators by means of standard cable clamps to fit the size of wire used.

To avoid electrical resonances which might cause distortion of the normal radiation pattern of the antenna, it is advisable to break each guy into sections of 19 to 20 feet by the insertion of strain insulators (see Figs. 13-25 and 13-26).

## Guy Material

Within their stress ratings, any of the halyard materials listed in Table 13-II may be used for the construction of guys. The nonmetallic materials have the advantage that they do not have to be broken up into sections to avoid resonances, but all of these materials are subject to stretching, which may cause mechanical problems in permanent installations. At rated working load tension, dry manila rope stretches about 5 percent, while nylon rope stretches about 20 percent.

The antenna wire listed in Table 13-I is also suitable for guys, particularly the copper-clad steel types. Solid galvanized steel wire is also used widely for making guys. This wire has approximately twice the tension ratings of similar sizes of copper-clad wire, but it is more susceptible to corrosion. Stranded galvanized wire sold for guying TV masts is also suitable for light-duty applications, but is susceptible to corrosion.

## Guy Anchors

Figs. 13-27 and 13-28 show two different styles of guy anchors. In Fig. 13-27, one or more pipes are driven into the earth at right angles to the guy wire. If a single pipe proves to be inadequate, another pipe can be added in tandem, as shown. Steel fence posts may be used in the same manner. Fig. 13-28 shows a "dead-man" type of anchor. The buried anchor may consist of one or more pipes 5 or 6 feet long, or scrap automobile parts, such as bumpers or wheels. The anchors should be buried 3 or 4 feet in the ground. Some tower manufacturers make heavy auger-type anchors that screw into the earth. These anchors are usually

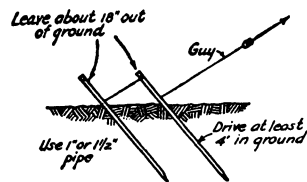

Fig. 13-27 — Driven guy anchors. One pipe will usually be sufficient for a small mast. For added strength, a second pipe may be added, as shown.



Fig. 13-28 — Buried "dead-man" type of guy anchor (see text).

heavier than required for guying a mast, although they may be more convenient to install. Trees and buildings may also be used as guy anchorages if they are located appropriately. Care should be exercised, however, to make sure that the tree is of adequate size, or that the fastening to a building can be made sufficiently secure.

### Guy Adjustment

Most troubles that are encountered in mast guying are a result of pulling the guy wires too tight. Guy-wire tension should never be more than is necessary to correct for obvious bowing or movement under wind pressure. In most cases, the tension needed will not require the use of turnbuckles, with the possible exception of the guy opposite the antenna. If any great difficulty is experienced in eliminating bowing from the mast, the antenna tension should be reduced.

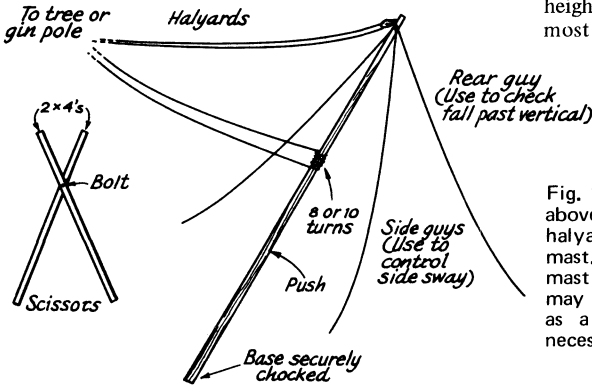

Fig. 13-29 — Pulling on a gin line fastened slightly above the center point of the mast and on the halyards will assist materially in erecting a tall mast. The tensions should be such as to keep the mast in as straight a line as possible. The scissors may be used to push on the under side and to serve as a rest in case a pause in raising becomes necessary.

## ERECTING A MAST

The erection of a mast of 30 feet or less can usually be done by simply "walking" the mast up after blocking the bottom end securely so that it can neither slip along the ground or upend when the mast is raised. A man should be stationed at each guy wire, and in the last stages of raising, some assistance may be desirable by pulling on the proper guy wire. Further assistance may be gained by using the halyards in the same manner. As the mast is raised, it may be helpful to follow the

under side of the mast with a scissors rest (Fig. 13-29), should a pause in the hoisting become necessary. The rest may also be used to assist in the raising, if a man is used on each leg.

As the mast nears the vertical position, those holding the guy wires should be ready to make the guys fast temporarily to prevent the mast from falling in one direction or another. The guys can then be adjusted, one at a time, until the mast is perfectly straight.

For a mast over 30 feet, a "gin" of some form may be required, as shown in Fig. 13-29. Several turns of rope are wound around a point on the mast above center. The ends of the rope are then brought together and passed over the limb of a tree. The rope should be pulled as the mast is walked up to keep the mast from bending at the center. If a tree is not available, a post, such as a 2 × 4, temporarily erected and guyed, can be used. After the mast has been erected, the assisting rope can be removed by walking one end around the mast (inside the guy wires).

### Other Supports

Much sturdier supports are telephone poles and towers. These types of supports are discussed later in reference to rotatable antennas. Such supports may require no guying, but they are not often used solely for the support of wire antennas because of their relative high cost. However, for antenna heights in excess of 50 feet, they are usually the most practical form of support.

### Bibliography

Source material and more extended discussion of topics covered in this chapter can be found in the references given below.

- Elengo, "Predicting Sag in Long Wire Antennas," *QST*, Jan., 1966.  
 Gann, "A Center-Fed 'Zepp' for 80 and 40," *QST*, May, 1966.  
 Gordon, "Invisible Antennas," *QST*, Nov. 1965.  
 Gue, "An 80-Meter Inverted Vee," *QST*, June, 1968.  
 McCoy, "An Easy-to-Make Coax-Fed Multiband Trap Dipole," *QST* Dec., 1964.

# Rotatable Antennas

Constructing an antenna which is to be rotated requires materials which are strong, lightweight, and easy to obtain. Procurement is often the most difficult portion of the project, but that can usually be overcome with some careful searching of the Yellow Page section of the telephone book for the nearest large metropolitan area. (Such telephone books may be available in the reference section of your local library.)

The materials required to build a suitable rotatable antenna will vary, depending on many factors. Perhaps the most important factor which determines the type of hardware needed is the weather conditions which are normally encountered. High winds usually don't cause as much damage to an antenna as does ice — or even heavy ice along with high winds. Aluminum sizes should be selected so that the various sections of tubing will telescope to provide the necessary total length. Table 14-I gives the specifications for aluminum which will meet the needs for most amateur installations.

The boom size for a rotatable Yagi or quad should be selected to provide stability to the entire system. The best diameter for the boom depends on several factors, but mostly the element weight, number of elements, and the overall length. Tubing diameters of 1-1/4 inches can easily support three-element 10-meter arrays and perhaps a two-element 15-meter system. For larger 10-meter antennas or for harsh weather conditions, and for antennas up to three elements on 20 meters or four elements on 15 meters, a two-inch diameter boom will be adequate. It is not recommended that two-inch diameter booms be made any longer than 24 feet unless additional support is given to reduce both vertical and horizontal bending forces. Suitable reinforcement for a long two-inch boom can consist of a truss or a truss and lateral support, as shown in Fig. 14-1.

A boom length of 24 feet is about the point where a 3-inch diameter begins to be very worthwhile. This dimension provides a considerable amount of improvement in overall mechanical stability as well as increased clamping surface area for element hardware. The latter is extremely important if heavy icing is commonplace and rotation of elements around the boom is to be avoided. Pinning an element to the boom with a large bolt helps in this regard. However, on the

smaller diameter booms, the elements sometimes work loose and tend to elongate the pinning holes in both the element and the boom. After some time, the elements shift their positions slightly (sometimes from day to day!) and give a rather ragged appearance to the system, even though this doesn't generally harm the electrical performance.

A three-inch diameter boom with a wall thickness of .065 inch is very satisfactory for antennas up in size to about a five-element 20-meter array which is spaced on a 40-foot long boom. A truss is recommended for any boom longer than 24 feet.

## CONSTRUCTION OF QUADS

Most of the constructional details relating to quads have been given in Chapter Nine. The sturdiness of a quad is directly proportional to the *quality* of the material used and the care with which it is constructed.

The size and type of wire selected for use with a quad antenna is important because it will determine the capability of the spreaders to withstand high winds and ice. One of the more common problems confronting the quad owner is that of broken wires. A solid conductor is more apt to break than stranded wire under constant flexing conditions. For this reason, copper stranded wire is recommended. For 20-, 15-, or 10-meter operation, wire size No. 14 or 12 is a good choice. Soldering of the stranded wire at points where flexing is likely to occur should be avoided.

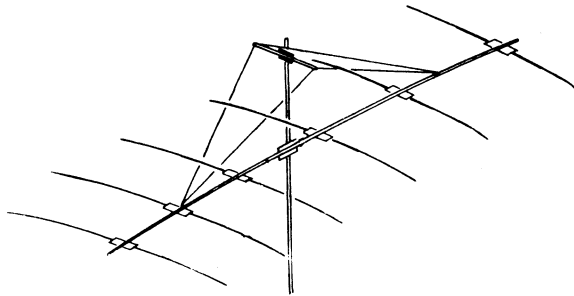

Fig. 14-1 — A long boom needs both vertical and horizontal support. The cross bar mounted above the boom can support a double truss which will help keep the antenna in position.

TABLE 14-I — STANDARD SIZES OF ALUMINUM TUBING

## 6061-T6 (61S-T6) ROUND ALUMINUM TUBE

In 12-Foot Lengths

O. D. WALL THICKNESS			I. D. Inches	APPROX. WEIGHT		O. D. WALL THICKNESS			I. D. Inches	APPROX. WEIGHT	
Inches	Inches	Stubs Ga.		Per Foot	Per Length	Inches	Inches	Stubs Ga.		Per Foot	Per Length
3/16"	.035 (No. 20)	.117	.019 lbs.	.228 lbs.	1"	.083 (No. 14)	.834	.281 lbs.	3.372 lbs.		
	.049 (No. 18)	.089	.025 lbs.	.330 lbs.		1 1/8"	.035 (No. 20)	1.055	.139 lbs.	1.668 lbs.	
1/4"	.035 (No. 20)	.180	.027 lbs.	.324 lbs.	1 1/4"		.058 (No. 17)	1.009	.228 lbs.	2.736 lbs.	
	.049 (No. 18)	.152	.036 lbs.	.432 lbs.		1 1/2"	.035 (No. 20)	1.180	.155 lbs.	1.860 lbs.	
	.058 (No. 17)	.134	.041 lbs.	.492 lbs.	.049 (No. 18)		1.152	.210 lbs.	2.520 lbs.		
5/16"	.035 (No. 20)	.242	.036 lbs.	.432 lbs.	.058 (No. 17)		1.134	.256 lbs.	3.072 lbs.		
	.049 (No. 18)	.214	.047 lbs.	.564 lbs.	.065 (No. 16)	1.120	.284 lbs.	3.408 lbs.			
	.058 (No. 17)	.196	.055 lbs.	.660 lbs.	.083 (No. 14)	1.084	.357 lbs.	4.284 lbs.			
3/8"	.035 (No. 20)	.305	.043 lbs.	.516 lbs.	1 3/8"	.035 (No. 20)	1.305	.173 lbs.	2.076 lbs.		
	.049 (No. 18)	.277	.060 lbs.	.720 lbs.		.058 (No. 17)	1.259	.282 lbs.	3.384 lbs.		
	.058 (No. 17)	.259	.068 lbs.	.816 lbs.	1 1/2"	.035 (No. 20)	1.430	.180 lbs.	2.160 lbs.		
	.065 (No. 16)	.245	.074 lbs.	.888 lbs.		.049 (No. 18)	1.402	.260 lbs.	3.120 lbs.		
7/16"	.035 (No. 20)	.367	.051 lbs.	.612 lbs.	.058 (No. 17)	1.384	.309 lbs.	3.708 lbs.			
	.049 (No. 18)	.339	.070 lbs.	.840 lbs.	.065 (No. 16)	1.370	.344 lbs.	4.128 lbs.			
	.065 (No. 16)	.307	.089 lbs.	1.068 lbs.	.083 (No. 14)	1.334	.434 lbs.	5.208 lbs.			
1/2"	.028 (No. 22)	.444	.049 lbs.	.588 lbs.	*.125 1/8"	1.250	.630 lbs.	7.416 lbs.			
	.035 (No. 20)	.430	.059 lbs.	.708 lbs.	*.250 1/4"	1.000	1.150 lbs.	14.832 lbs.			
	.049 (No. 18)	.402	.082 lbs.	.984 lbs.	1 5/8"	.035 (No. 20)	1.555	.206 lbs.	2.472 lbs.		
	.058 (No. 17)	.384	.095 lbs.	1.040 lbs.		.058 (No. 17)	1.509	.336 lbs.	4.032 lbs.		
	.065 (No. 16)	.370	.107 lbs.	1.284 lbs.	1 3/4"	.058 (No. 17)	1.634	.363 lbs.	4.356 lbs.		
5/8"	.028 (No. 22)	.569	.061 lbs.	.732 lbs.		.083 (No. 14)	1.584	.510 lbs.	6.120 lbs.		
	.035 (No. 20)	.555	.075 lbs.	.900 lbs.	1 7/8"	.058 (No. 17)	1.759	.389 lbs.	4.668 lbs.		
	.049 (No. 18)	.527	.106 lbs.	1.272 lbs.		2"	.049 (No. 18)	1.902	.350 lbs.	4.200 lbs.	
	.058 (No. 17)	.509	.121 lbs.	1.452 lbs.	.065 (No. 16)		1.870	.450 lbs.	5.400 lbs.		
.065 (No. 16)	.495	.137 lbs.	1.644 lbs.	.083 (No. 14)	1.834	.590 lbs.	7.080 lbs.				
3/4"	.035 (No. 20)	.680	.091 lbs.	1.092 lbs.	*.125 1/8"	1.750	.870 lbs.	9.960 lbs.			
	.049 (No. 18)	.652	.125 lbs.	1.500 lbs.	*.250 1/4"	1.500	1.620 lbs.	19.920 lbs.			
	.058 (No. 17)	.634	.148 lbs.	1.776 lbs.	2 1/4"	.049 (No. 18)	2.152	.398 lbs.	4.776 lbs.		
	.065 (No. 16)	.620	.160 lbs.	1.920 lbs.		.065 (No. 16)	2.120	.520 lbs.	6.240 lbs.		
.083 (No. 14)	.584	.204 lbs.	2.448 lbs.	.083 (No. 14)	2.084	.660 lbs.	7.920 lbs.				
7/8"	.035 (No. 20)	.805	.108 lbs.	1.308 lbs.	2 1/2"	.065 (No. 16)	2.370	.587 lbs.	7.044 lbs.		
	.049 (No. 18)	.777	.151 lbs.	1.810 lbs.		.083 (No. 14)	2.334	.740 lbs.	8.880 lbs.		
	.058 (No. 17)	.759	.175 lbs.	2.100 lbs.	*.125 1/8"	2.250	1.100 lbs.	12.720 lbs.			
	.065 (No. 16)	.745	.199 lbs.	2.399 lbs.	*.250 1/4"	2.000	2.080 lbs.	25.440 lbs.			
1"	.035 (No. 20)	.930	.123 lbs.	1.476 lbs.	3"	.065 (No. 16)	2.870	.710 lbs.	8.520 lbs.		
	.049 (No. 18)	.902	.170 lbs.	2.040 lbs.		*.125 1/8"	2.700	1.330 lbs.	15.600 lbs.		
	.058 (No. 17)	.884	.202 lbs.	2.424 lbs.	*.250 1/4"	2.500	2.540 lbs.	31.200 lbs.			
	.065 (No. 16)	.870	.220 lbs.	2.640 lbs.							

\*These sizes are extruded; all other sizes are drawn tubes. Shown here are standard sizes of aluminum tubing that are stocked by most aluminum suppliers or distributors in the United States and Canada. Note that all tubing comes in 12-foot lengths and also that any diameter tubing will fit into the next larger size, if the larger size has a .058-inch wall thickness. For example, 5/8-inch tubing has an outside diameter of 0.625 inches and will fit into 3/4-inch tubing with a .058-inch wall which has an inside diameter of 0.634 inch. The .009-inch clearance is just right for a slip fit or for slotting the tubing and then using hose clamps. The 6061-T6 type of aluminum is of relatively high strength and has good workability, plus being highly resistant to corrosion and will bend without taking a "set." Check the Yellow Pages for aluminum dealers.

Connecting the wires to the spreader arms may be accomplished in many ways. The simplest method is to drill holes through the fiber glass at the appropriate points on the arms and route the wires through the holes. Soldering a wire loop across the spreader, as shown in Chapter Nine, is recommended. However, care should be taken to prevent solder from flowing to the corner point where flexing could break it.

Dimensions for quad elements and spacing have been given in texts and *QST* over the years. It is generally felt that quads are not very critical in their tuning, nor is element spacing very critical. Table 14-II is a collection of dimensions that will suit almost every amateur need for a quad system.

A boom diameter of two inches is recommended for systems having two or three elements for 20, 15, and 10 meters. When the boom length

TABLE 14-II — QUAD DIMENSIONS

2 element Quad (WØHHTH)

Spacing (given below)

Boom length (given below)

Band	40 M.	20 M.	15 M.	10 M.
Reflector	144' 11½"	72' 4"	48' 8"	35' 7"
Driven Element	140' 11½"	70' 2"	47' 4"	34' 7"
Spacing	30'	13'	10'	6' 6"
Boom length	30'	13'	10'	6' 6"
Feed method	Directly with 23' of RG11, then any length of RG8 coax.	Directly with 11' length RG8 coax.	Directly with 7' 8½" RG11, then any length RG8 coax.	Directly with 5' 8" RG11, then any length RG8 coax.

(Note that a spider or boomless quad arrangement could be used for the 10/15/20 meter parts of the above dimensions yielding a triband antenna)

4 element Quad\* (WØAIW (20 M.) /WØHHTH\*\* /KØKKU/KØEZH/W6FXB)

Spacing: equal; 10 ft.

Boom length: 30 ft.

Band	20 M.	15 M.	10 M.
	Phone CW		
Reflector	72' 1½" 72' 5"	48' 8"	35' 8½"
Driven Element	70' 1½" 70' 5"	47' 4"	34' 8½"
Director 1	69' 1" 69' 1"	46' 4"	33' 7¼"
Director 2	69' 1" 69' 1"	46' 4"	33' 7¼"
Feed Method	Directly with 50-ohm coax.	Directly with 50-ohm coax.	Directly with 5' 9" RG11, then any length RG8 coax.

\* Common boom used to form a triband array.

\*\* The 2-element 40-meter quad given above is added to form a four-band quad array.

4 element Quad (WØHHTH/K8DYZ\*/K8YIB\*/W7EPA\*)

Spacing: equal; 13' 4".

Boom length: 40 ft.

Band	20 M.	15 M.	10 M.
Reflector	72' 5"	48' 4"	35' 8½"
Driven Element	70' 5"	47' 0"	34' 8½"*
Director 1	69' 1"	46' 1"	(Directors 1-3 all 33' 7")*
Director 2	69' 1"	46' 1"	
Feed method	Directly with 50-ohm coax.	Directly with 7' length 50-ohm coax.	Directly with 9" RG11, then any 50-ohm coax.

\* For the 10-meter band the driven element is placed between the 20/15 reflector and 20/15 driven element. The 10-meter reflector is placed on the same frame as the 20/15-meter reflectors and the remaining 10-meter directors are placed on the remaining 20/15-meter frames. The 10-meter portion is then a 5-element quad.

6 element Quad (WØYDM, W7UMJ)

Spacing: equal; 12 ft.

Boom length: 60 ft.

Band: 20 M.

Reflector	72' 1½"
Driven Element	70' 1½"
Directors 1, 2 and 3	69' 1"
Director 4	69' 4"
Feed Method	Directly with 50-ohm coax.

becomes 20 feet or longer, as encountered with four- and five-element antennas, a three-inch diameter boom is highly recommended. Wind creates two forces on the boom, vertical and horizontal. The vertical load on the boom can be reduced with a guy-wire truss cable. The horizontal forces on the

boom are more difficult to relieve, and the larger size of three-inch-diameter tubing is desirable.

There are, generally speaking, three grades of materials which can be used for quad spreaders. The least expensive material is bamboo. Bamboo poles are available from many rug stores and cost



Fig. 14-2 — The Ham-M rotor control.

less than a dollar each. Bamboo, however, is also the weakest material normally used for quad construction. It has a short life, typically only a few years, and will not withstand a harsh climate very well. Additionally, bamboo is heavy in contrast to fiber glass, which weighs only about a pound per 13-foot length. Fiber glass is the most popular type of spreader material, and will withstand normal winter climates. One step beyond the conventional fiber-glass arm is the pole-vaulting arm. For quads designed to be used on 40-meters, surplus "rejected" pole-vaulting poles are highly recommended. Their ability to withstand large amounts of bending is very desirable. The cost of these poles is high, and they are difficult to obtain. Those interested should check with sporting goods manufacturers.

## ROTATING SYSTEMS

There are not many choices when it comes to antenna rotators or rotors for the amateur antenna system. However, making the correct decision as to how big the rotor needs to be is very important if trouble-free operation is desired! There are basically four grades of rotors available to the amateur. The lightest duty rotor is the TV type, typically used to turn TV antennas. The cost may range from 20 to about 50 dollars. These rotors will handle, without much difficulty, a small three-element tribander (20-, 15-, and 10-meter) array or a single 15- or 10-meter monoband three-element antenna. The important consideration with a TV rotor is that it lacks braking or holding capability. High winds will turn the rotor motor via the gear train in a reverse fashion. Sometimes broken gears result. The next grade up from the TV class of rotors usually includes a braking arrangement whereby the antenna is held in place when power is not applied to the rotor. Generally speaking, the

brake will prevent gear damage on windy days. This group of rotors costs from 100 to 250 dollars. If adequate precautions are taken, this group of rotors is capable of holding and turning stacked monoband arrays, or up to a five-element 20-meter system. The next step up in strength is more expensive. This class of rotator will turn just about anything the most demanding amateur might want to install, and typically costs more than 350 dollars.

A description of antenna rotors would not be complete without the mention of the prop-pitch class. The prop-pitch rotor system consists of a surplus aircraft propeller-blade pitch motor coupled to an indicator system as well as a power supply. There are mechanical problems of installation, however. It has been said that a prop-pitch rotor system, properly installed, is capable of turning a house. This is no doubt true! Perhaps in the same class as the prop-pitch motor but with somewhat less capability is the electric motor of the type used for opening garage doors. These have been used successfully in turning quite large arrays.

Proper installation of the antenna rotor can provide many years of trouble-free service; sloppy installation can cause problems such as a burned-out motor, slippage, binding, and casting breakage. Most rotors are capable of accepting most sizes of different diameters, and suitable precautions must be taken to shim an undersized mast to assure dead-center rotation. It is very desirable to mount the rotor inside and as far below the top of the tower as possible. The mast will absorb the torsion developed by the antenna during high winds, as well as during starting and stopping. A mast length of 10 feet or more between the rotor and the antenna will add greatly to the longevity of the entire system. Some amateurs have used a long mast from the top to the base of the tower. Installation and service can be accomplished at ground level. Another benefit of mounting the rotor ten or more feet below the antenna is that any misalignment between the rotor, mast, and the top of the tower is less significant. A tube at the top of the tower through which the mast protrudes will almost completely eliminate any lateral forces on the rotor casting. All the rotor need do is support the downward weight of the antenna system and turn the array. While the normal weight of the antenna and the mast is usually not more than a couple of hundred pounds, even with a large system, one can ease this strain on the rotor by installing a thrust bearing at the top of the tower. The bearing is then the component which holds all of the weight, and the rotor need perform only the rotating task.

A problem often encountered in the amateur installation is that of misalignment between the direction indication of the rotor control box and the heading of the antenna. This is caused by mechanical slippage in the system due to loose rotor bolts or antenna boom-to-mast hardware. Many texts suggest that the boom be pinned to the mast with a heavy-duty bolt and, likewise, the rotor be pinned to the mast. There is a trade-off here. The amateur might not like to climb his tower and straighten out the assembly after each



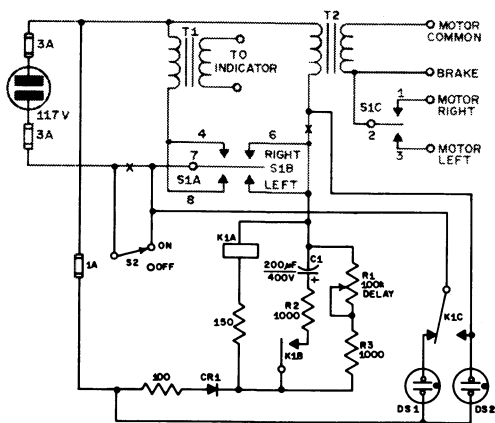

Fig. 14-3 — Diagram of the modified Ham-M rotor-control box. Fixed-value resistors are 1-watt composition. Connections must be broken at the two places marked "X." The shaded lines indicate original wiring and the heavy lines are additions to the original circuit. Parts designations not listed below are for text reference.

- C1 — 200-µF, 450-volt electrolytic.
- CR1 — 1000-volt PRV, 750-mA silicon rectifier.
- DS1, DS2 — Neon panel lamp, 117 V ac.
- K1 — Dpdt, 3-A contacts, 5000-ohm coil.
- R1 — 100,000-ohm linear taper composition.

heavy wind storm. However, if there is sufficient wind to cause slippage in the couplings, perhaps the wind could break a rotor casting. The slippage will act as a clutch release which *may* prevent serious rotor damage.

### DELAYED-ACTION BRAKING FOR THE HAM-M ROTOR

On most rotors equipped with braking capabilities, the brake is applied almost instantly after power is removed from the rotor motor, to stop the array from rotating and hold it at a chosen bearing. Because of inertia, however, the array itself does not stop rotating instantly. The larger and heavier the antenna, the more it will tend to continue its travel, in which case the mast may absorb the torsion, the entire tower may twist back and forth, or the brake of the rotor may shear. A more suitable system is to remove power from the rotor motor during rotation *before* the desired bearing is reached, allowing the beam to coast to a slower speed or to a complete stop before the brake is applied. The Ham-M rotor system may be modified to have delayed-action braking by adding external controls and components. A convenient method of installation is shown in Fig. 14-2.

The Ham-M control box has one switch that handles all of the switching functions, S1 of Fig. 14-3. Contacts 4, 7, and 8 apply voltage to transformer T1, which supplies voltage to the indicator meter. (A modification listed in the Ham-M instruction book mentions how to change the switching arrangement to allow continuous

monitoring of the antenna heading.) S2 in Fig. 14-3 is incorporated in the circuit for turning off the control box. Contacts 6 and 7 of S1 are used to energize T2. This function immediately activates the brake-release mechanism. At the same time, a third set of switch contacts (1, 2, and 3) determines the direction of rotation. When the antenna reaches a certain heading the operator returns the switch to center position. It is at this point when the solenoid releases the brake wedge so that it can drop back into place on the ring gear, abruptly halting the movement of the antenna and mast. The possibility of motor damage can be greatly reduced with this modification. It will hold the brake open while the antenna coasts to a stop.

The shaded lines in Fig. 14-3 show part of the original Ham-M circuit. The dark lines represent the additional connections needed to perform the brake-delay functions. When S1 is activated K1A immediately closes, allowing C1 to charge through R2. K1C is used to apply voltage to T2 which, in turn, opens the brake. Depending on which way the lever is pushed, the antenna turns either left or right. When S1 is released, voltage to the rotator is interrupted by S1C, but K1 remains energized, keeping the brake open until C1 discharges through R2, R3, and R1. The time required for the voltage from C1 to drop to a point where K1 deenergizes is determined by the setting of R1. The range is from 2 to 8 seconds. Two neon lamps, DS1 and DS2, are used to provide visual indication of the brake position.

### Construction

No special wiring precautions are necessary. The control circuitry added to the rotator is completely contained in the homemade chassis

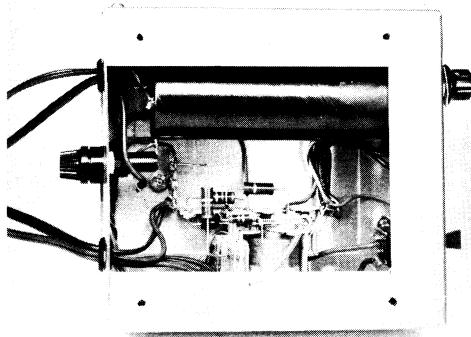

Fig. 14-4 — This top view of the homemade chassis shows the location of the components. A bottom plate is permanently attached to this unit using 6-32 screws which also hold the rubber feet in place. The four short interconnecting leads run through rubber grommets on the rear of the chassis. The wires should be secured inside the cabinet to prevent them from being pulled loose. The large electrolytic capacitor is mounted to the bottom plate using two small terminal strips.

box. Four short pieces of line cord interconnect the two boxes.

The chassis shown in the photograph is  $6 \times 6 \times 2$  inches. It was designed to allow the Ham-M control box to sit on top of it. A Bud AC-1413 aluminum chassis could be used if the builder doesn't want to construct his own. Fig. 14-4 shows the internal layout. A bottom cover should be used on the chassis to prevent the operator from accidentally contacting ac voltage.

### Operation

Front-panel control of the delay is desirable. Different time periods are required depending on prevailing winds and the size of the antenna. The operator soon gets a feel for when to let go of the switch to have the antenna stop at the right place. On extremely windy days the delay time should be short to keep the array from windmilling. But on reasonably calm days, the antenna will come to a full stop in less than 5 seconds; therefore the delay time should be set to near maximum. The antenna usually drifts less than 10 degrees.

## A DIRECTIONAL INDICATOR FOR THE HY-GAIN MODEL 400 ROTOR

The Hy-Gain rotor system is a heavy-duty rotational device which can be used to turn large arrays. The control box is designed to have a direction dialed on the front-panel compass face, and when power is applied to the unit the rotor will turn to the designated heading and then shut off automatically. While the automatic feature is handy for casual operating, the serious DXer or contester might like to have an indication of the antenna (or rotor) position during the actual turning period, which the conventional control does not provide. The control system described below was designed to be used in place of the Hy-Gain control unit, and with the exception of the motor starting capacitor, no parts from the original control are used. One additional feature is provided: The rectifying components which power the rotor brake are located in the rotor as provided

by the manufacturer. If a component fails, the rotor must be removed from the tower for repairs. For this reason, two extra conductors were added to the existing control cable and the brake power components were placed in the control box.

The modification of the rotor is best done in the workshop. These modifications can be performed while standing on the tower with the rotor mounted in position, but it is more difficult.

The first step is to remove the two diodes, the electrolytic capacitor, and the 10-ohm resistor from the rotor motor housing. The terminal strip is set up for five screw positions. Originally the two diodes were connected to a sixth terminal which will be used for brake control with the modified system. A seventh wire will be required for the indicator system. Connect this wire to the *unused* terminal of the potentiometer and route it out through the rubber bushing. It then may be spliced into the control cable which has been modified for seven conductors. The two new wires do not handle much current, and therefore need not be greater than No. 18 for runs up to 250 feet. This completes the modification of the rotor motor assembly.

The construction of a control box is the most difficult portion of the project. For the model shown in Figs. 14-5 and 14-7, a Minibox, sized to house the meter and control knobs, was used. The overall size of the housing will be determined by the size of the meter frame. For calibration purposes, a large meter-face area is desirable.

The Hy-Gain 400 rotor is designed to have about 30 degrees of rotational overlap. Unfortunately there are no end-of-rotation limit switches provided, and it is possible to turn this device several times around in the same direction. Needless to say, the coaxial feed line will not withstand this kind of treatment. In order to keep the control circuitry simple, it was decided to use two switches, one for turning on power to the system, and one for determining the direction of rotation. The ROTATE switch needs to be spring-loaded for the OFF position. The purpose is to assure that the operator keeps his mind on what he is doing while the antenna is rotating. The spring loading acts as a dead-man switch — one can't go away and leave it turned on.

The circuit for the control box is given in Fig. 14-6. A conventional low-current (less than an ampere at 6.3 V) transformer is used to provide a regulated 8.2 volts dc to drive the indicator circuit. The value of the voltage is not critical, and any voltage from about six to as high as ten will suffice. Regulation is desirable to assure the calibration won't change under changing line-voltage conditions. R1 is a linear-taper two-watt composition control. The meter was obtained from Simpson Electric and is their model 524. The internal resistance is 43 ohms.

Control of the brake at the rotor is provided by 120 volts of dc developed by CR2 or CR3 in the control box. The voltage appears at terminal six each time voltage is applied to the rotor motor. A small pilot lamp is used to assure the operator that the rotor motor isn't working against a closed brake.

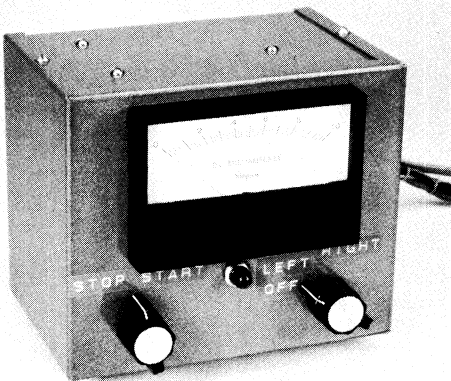
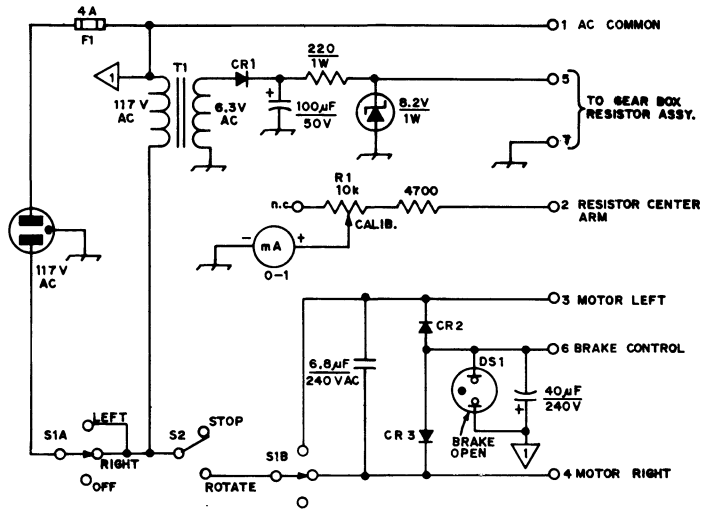

Fig. 14-5 — Front view of the Hy-Gain control box.

Fig. 14-6 — Circuit diagram for the Hy-Gain rotor control box. The 6.8- $\mu$ F, 240-V ac capacitor is taken from the original Hy-Gain control head. CR1, CR2 and CR3 are conventional power diodes, 1000 PRV at 1 A. T1 is rated for one ampere. R1 is a linear-taper composition two-watt control. The indicator meter shown in the photographs is a model 524, manufactured by Simpson Electric. S2 is a spring-return type.



The potentiometer in the rotor housing is gear driven to allow the antenna to turn approximately 380 degrees while the resistor turns through only about 270 degrees. The easiest way to calibrate the overall system is to turn the rotor motor until the potentiometer is at midposition of its travel. This can be determined with an ohmmeter by observing the resistance between rotor wires two and seven. Since the value of the potentiometer is about 5000 ohms, an ohmmeter reading of 2500 ohms will indicate midposition. Next, the rotor should be installed and the antenna positioned so that its heading is correct for the predetermined center heading for the indicator. Then the antenna should be rotated 180 degrees *as noted by visual inspection of the antenna*. Do not use the control box for the indication. After the antenna has been rotated 180 degrees, the indicator may be labeled for the correct position. Rotate the antenna 360 degrees in the opposite direction, again observing the antenna (not the control box). When the antenna is in position the proper heading may be marked on the meter face. With the system shown in the photographs, the center was set for north. South appears on the meter at 15 and 85 percent of full scale deflection.

Operation of the new control is similar to other rotor systems. The operator should first select the direction he wants to turn the antenna, then select the ROTATE position of S2. Since the indicator provides continuous indication of the antenna heading, one can observe the heading even when the antenna is not rotating. Selecting the OFF position of S1 completely disables the rotor control box.

**TOWER SELECTION AND INSTALLATION**

Probably the most important part of any amateur radio installation is the antenna system. It determines the effectiveness of the signal transmitted at a particular power level. In terms of dollar investment, the antenna provides double duty; while it can provide gain during transmitting

periods (which can also be accomplished by increasing transmitter power), it has the same beneficial effect on received signals. Therefore, a tall support for an antenna which has gain, and which can be rotated, is very desirable. This is especially true if DX contacts are of prime interest on the 20-15- and 10-meter bands.

Of the two important features of an antenna system, height and antenna gain, height is usually considered the most important, if the antenna is horizontally polarized. The typical amateur installation consists of a three-element triband beam (tribander) for 20, 15 and 10 meters mounted on a tower which may be as low as 25 or 30 feet, or as

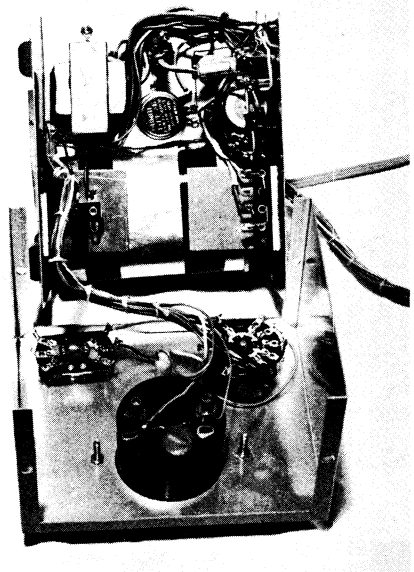

Fig. 14-7 — Inside view of the Hy-Gain control box.

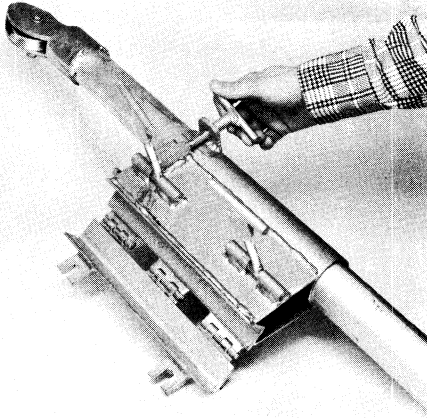

Fig. 14-8 — A gin pole is a mechanical device which can be clamped to a tower leg to aid in the assembly of sections as well as the installation of antennas. The aluminum tubing extends through the clamp and may be slipped into position before the tubing clamp is tightened. A rope should be routed through the tubing and over the pulley mounted at the top. See Fig. 14-9 for installation details.

high as 65 or 70 feet. Some exotic systems use large antennas on much taller towers.

The selection of a tower, its height, and the type of antenna and rotor to be used all may seem like a complicated matter, particularly for the newcomer to amateur radio. These four aspects of an antenna system are completely interrelated, and one should consider the overall system before making any decisions as to a specific component. Perhaps the most important consideration for many amateurs is the effect of the antenna system on the surrounding environment. If plenty of space is available for a tower installation and there is little chance of the antenna irritating neighbors, the amateur is indeed fortunate. This amateur's limitations will be mostly financial. But for most amateurs, the size of the backyard, the effect of the system on members of the family and neighbors, local ordinances, and the proximity of power lines and poles contribute a considerable influence on the overall selection of antenna components.

The amateur must consider the practical limitations for his installation. Some points for consideration are given below:

1) A tower should never be installed in a position whereby it could conceivably fall onto a neighbor's property.

2) The antenna must be located in such a position that it *cannot possibly tangle with power lines during normal operation* (!) or if a disastrous wind storm comes along.

3) Sufficient yard space must be available to position a guyed tower *properly*. The guy anchors should be between 60 and 80 percent of the tower height in distance from the base of the tower.

4) Provisions must be made to keep neighborhood children from climbing the support. Chicken wire around the tower base will serve this need nicely.

5) Local ordinances should be checked to determine if any legal restrictions are on record.

Other important points are:

6) The total dollar value to be invested.

7) The size and weight of the antenna desired.

8) The overall yearly climate.

9) Ability of the owner to climb a fixed tower.

The selection of a tower support is usually dictated more by circumstances than by desire. The most economical system, in terms of feet-per-dollar investment, is a guyed tower. Rohn type 25 tower is suitable to any reasonable height if guyed properly. Details of installation are given later. The crank-up style of tower is very handy if the operator doesn't wish to climb any more than 20 feet to work on his antennas. Crank-up towers come in both guyed and free-standing configurations. The trade-off with a crank-up tower is that it doesn't completely eliminate tower climbing as a necessity, and they are, to an extent, dangerous if mishandled or operated carelessly. The free-standing fixed tower will suit many situations if the owner's backyard doesn't have sufficient space to allow proper guying of a lighter weight system. Another type of arrangement which is very popular is the crank-down, fold-over support. These



Fig. 14-9 — The assembly of tower sections is made simple when a gin pole is used to lift each one into position. Note that the safety belts of both climbers are fastened below the pole thereby preventing the strap from slipping over the top section. (Photo by K1THQ)

systems crank down to about 20 feet, and then may be folded over to allow access from the ground level. Strictly fold-over towers are also available, which allow tower work to be accomplished from the ground level, but do not allow the tower to be cranked down during periods of nonuse or during extremely bad weather.

Once a decision has been tentatively made, the next step is to write to the manufacturer and request a specification sheet. Meanwhile, one should lay out any guy anchor points needed to assure that they will fit on the assigned property. The specification sheet for the tower should give a wind-load capability, and an antenna can then be selected which will not overload it. If a tentative decision on the antenna type is made, a note to the antenna manufacturer giving the complete set of details for installation is not a bad idea. Be sure to give complete details of your plans, including all specifications of the antenna system planned. Remember, *the manufacturer will not custom design a system directly for your needs*, but he may offer comments on any of your ideas.

It is often very helpful to the novice tower installer to visit other local amateurs who have installed towers. Look over their hardware and ask questions. If possible, have a few local experienced amateurs look over your plans – before you

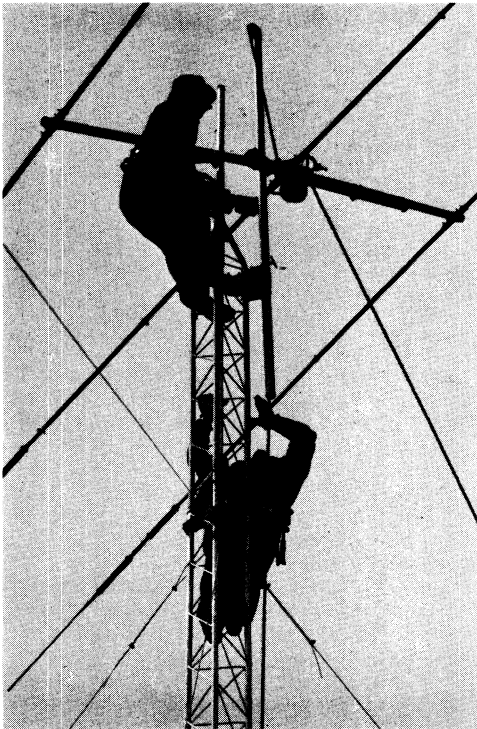

Fig. 14-10 – A gin pole is helpful in positioning the antenna before the mounting bolts are tightened to the mast. (Photo by K1THQ)



Fig. 14-11 – Proper tension can be placed on the guy wires with the aid of a block-and-tackle system. (Photo by K1THQ)

commit yourself. They may be able to offer a great deal of help. If someone in your area is planning to install a tower and antenna system, be sure to offer your assistance. There is no substitute for experience when it comes to tower work, and your experience there may prove invaluable to you later.

The installation of a tower is not difficult when the proper techniques are known. A guyed tower, in particular, is not hard to erect since each of the individual sections are relatively light in weight and can be handled with only a few helpers and some good-quality rope. A gin pole is a handy device for working with tower sections. The gin pole shown in Fig. 14-8 is designed to fit around the leg of Rohn No. 25 tower and clamp in place. The tubing, which is about 12 feet long, has a pulley on one end. A rope is routed through the tubing and over the pulley. When the gin pole is attached to the tower and the tubing is extended into place and locked, the rope may be used to haul tower sections and the antenna into place. Figs. 14-9 and 14-10 show the basic process.

When a guyed tower is used, guy anchor points are needed. These anchor points come in two styles, screw in and cement in. The cement anchor types consist of a steel rod which is equipped with a hook at the end. The hook is placed in a hole which has been prepared in accordance with the manufacturer's instructions. Contrary to what most inexperienced amateurs think, the anchors are positioned in line with the guy cable, not at right angles to it or up straight. (See Fig. 14-12.)

Unless many helpers are available, it will probably be impossible to pull up the guy wires to sufficient tension either by hand or by screwing in the turnbuckles. It is best to use a come-along (mechanical power hoist) or block and tackle, as shown in Fig. 14-11. In a three-way guy anchor system, it is important not to overtighten the first guy wire. It is possible to bend the tower over to a point that when the other guys are tightened in place, they are not able to straighten out the tower.

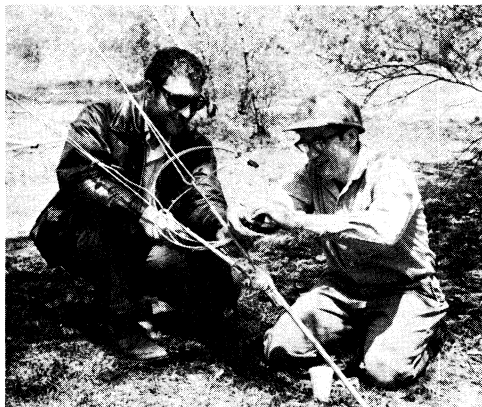

Fig. 14-12 — A guy cable is used to assure the turnbuckles remain in place after they are tightened. This procedure is an absolute requirement for a guyed tower system. (Photo by K1THQ)

After the guy wires are installed, it is necessary that the turnbuckles be looped with an extra piece of guy wire. The purpose is to prevent any twist in the wire (especially when it is new) from unscrewing the turnbuckles. The wire loop should be clamped in position as shown in Fig. 14-12.

As with any building project, the placement of the base and first section of tower will determine the straightness of the final product. To get the first section true, a carpenter's level of about three or four feet in length is ideal. Spot checks as the tower is assembled will aid in keeping the installation from looking tilted. A simple expedient is to stand away from the tower and sight along a string which suspends a plumb bob, with the top end of the string held high in the air at arm's length.

The installation of other types of towers similar to that shown in the photographs will use the same basic techniques. The manufacturer's instruction sheet should be followed in every detail to assure proper safety of the system.

### Safety

One of the most important aspects of any tower-installation project is the safety of all persons involved. The use of hard hats is highly recommended for all assistants helping from the ground. Helpers should always stand clear of the tower base to prevent being hit by a dropped tool or hardware. A good grade of climber's safety belt

should be used by each person working on the tower, such as is shown in Fig. 14-13. When climbing the tower, if more than one person is involved, one should climb into position before the other begins climbing. The same procedure is required for climbing down a tower after the job is completed. The purpose is to have the nonclimbing person stand relatively still so as not to drop any tools or objects on the climbing person, or unintentionally obstruct his movements. When two persons are working on top of a tower, only one should change position (unbelt and move) at a time.

For most installations, a good-quality 1/2-inch-diameter manilla hemp rope will be able to handle adequately the work load for the hoisting tasks. The rope must be periodically inspected to assure that no tearing or chafing has developed, and if the rope should get wet from rain, it should be hung out to dry at the first opportunity. Safety knots should be used to assure that none come loose during the hoisting of a tower section or antenna.



Fig. 14-13 — A good-quality safety belt is a requirement for working on a tower. The belt should contain large steel loops for the strap snap. Leather loops at the rear of the belt are handy for holding tools. (Photo by K1THQ)

# Mobile Antennas

## HF – MOBILE FUNDAMENTALS

Few amateurs construct their own antennas for hf-mobile use since safety reasons dictate a very sound mechanical construction. However, most installations using commercially made components still have to be optimized for the particular installation and type of operation desired.

The drawing of Fig. 15-1 shows a typical bumper-mounted center-loaded whip suitable for operation in the hf range. The antenna could also be mounted on the car body proper (such as a fender), and mounts are available for this purpose. The base spring acts as a shock absorber for the base of the whip since the continual flexing while in motion would otherwise weaken the antenna. A short heavy mast section is mounted between the base spring and loading coil. Some models have a mechanism which allows the antenna to be tipped over for adjustment or for fastening to the roof of the car when not in use. It is also advisable to extend a couple of guy lines from the base of the loading coil to clips or hooks fastened to the rain trough on the roof of the car. Nylon fishing line of about 40-pound test strength is suitable for this purpose. The guy lines act as safety cords and also reduce the swaying motion of the antenna considerably. The feed line to the transmitter is connected to the bumper and base of the antenna. Good low-resistance connections are important here.

Tune-up of the antenna is usually accomplished by changing the height of the adjustable whip section above the precut loading coil. First, tune the receiver and try to determine where the signals seem to peak up. Once this frequency is found, check the SWR with the transmitter on, seeking the frequency of lowest SWR. Shortening the adjustable section will increase the resonant frequency and making it longer will lower the frequency. It is important that the antenna be away from surrounding objects such as overhead wires, ten feet or more, since considerable detuning can occur. Once the setting is found where the SWR is lowest at the center of the desired operating frequency range, the length of the adjustable section should be recorded.

Propagation conditions and ignition noise are usually the limiting factors for mobile operation on 20, 15, and 10 meters, while antenna-size restric-

tions greatly affect operation on 160, 80, and 40 meters. From this standpoint, perhaps the optimum band for hf-mobile operation is 40 meters. The popularity of the regional mobile nets on 7255 and 7258 kHz is perhaps the best indication of its suitability. For local work, 10 meters is also useful since antenna efficiency is high and relatively simple antennas without loading coils are possible.

As the frequency of operation is lowered, an antenna of fixed length looks at its base feed point like a decreasing resistance in series with an increasing capacitive reactance. The capacitive reactance must be tuned out, which necessitates the use of a series inductive reactance or loading coil. The amount of inductance required will be determined by the placement of the coil in the antenna system. Base loading requires the lowest value of inductance for a fixed-length antenna, and as the coil is placed farther up the whip, the necessary value increases. This is because the capacitance of the shorter antenna section (above the coil) to the car body is now lower (higher capacitive reactance), requiring a bigger inductance in order to tune the antenna to resonance. The advantage is that the current distribution in the whip is improved, which increases the radiation resistance. The disadvantage is that requirement of a larger coil also means the coil losses go up. Center loading has been generally accepted as a good compromise with minimal construction problems.

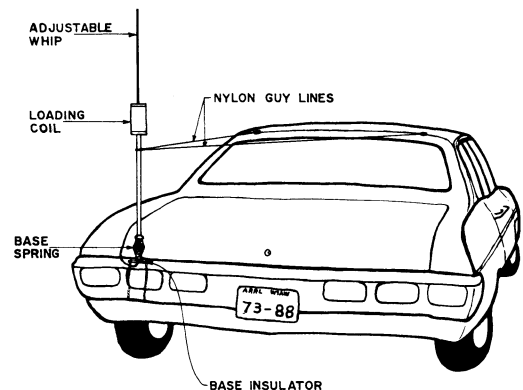

Fig. 15-1 — A typical bumper-mounted hf-mobile antenna. Note the nylon guy lines.

The difficulty in constructing suitable loading coils increases as the frequency of operation is lowered for typical antenna lengths used in mobile work. Since the required resonating inductance gets larger and the radiation resistance decreases at lower frequencies, most of the power may be dissipated in the coil resistance and in other ohmic losses. This is one reason why it is advisable to buy a commercially made loading coil with the highest power rating possible, even though only low-power operation is contemplated. Percentwise, the coil losses in the higher power loading coils are usually less, with subsequent improvement in radiating efficiency, regardless of the power level used. Of course, the above philosophy also applies to homemade loading coils, and design considerations will be considered in a later section.

Once the antenna is tuned to resonance, the input impedance at the antenna terminals will look like a pure resistance. Neglecting losses, this value drops from nearly 15 ohms on 15 m to 0.1 ohm on 160 m for an 8-foot whip. When coil and other losses are included, the input resistance increases to approximately 20 ohms on 160 m and 16 ohms on 15 m. These values are for relatively high-efficiency systems. From this it can be seen that the radiating efficiency is much poorer on 160 m than on 15 m under typical conditions.

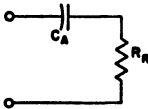

Fig. 15-2 — At frequencies below the resonant frequency, the whip antenna will show capacitive reactance as well as resistance.  $R_R$  is the radiation resistance, and  $C_A$  represents the capacitive reactance.

Since most modern gear is designed to operate with a 50-ohm transmission line, a matching network may be necessary with the high-efficiency antennas previously mentioned. This can take the form of either a broad-band transformer, tapped coil, or an  $LC$ -matching network. With homemade or modified designs, the tapped-coil arrangement is perhaps the easiest one to build, while the broad-band transformer requires no adjustment. As the losses go up, so does the input resistance, and in less efficient systems the matching network may be eliminated.

#### The Equivalent Circuit of a Typical Mobile Antenna

In the previous section, some of the general considerations were discussed, and these will now be taken up in more detail. It is customary in solving problems involving electric and magnetic fields (such as antenna systems) to try to find an equivalent network to replace the antenna. In many cases, the network may be an accurate representation only over a limited frequency range. However, this is often a valuable method in matching the antenna to the transmission line.

Antenna resonance is defined as the frequency at which the input impedance at the antenna terminals is a pure resistance. The shortest length at which this occurs for a vertical antenna over a ground plane is when the antenna is a quarter wavelength long at the operating frequency; the impedance value for this length (neglecting losses) is about 36 ohms. The idea of resonance can be extended to antennas shorter (or longer) than a quarter wave, and only means that the input impedance is purely resistive. As pointed out previously, when the frequency is lowered, the antenna looks like a series  $RC$  circuit, as shown in Fig. 15-2. For the average 8-ft. whip, the reactance of  $C_A$  may range from about 150 ohms at 21 MHz to as high as 8000 ohms at 1.8 MHz, while the radiation resistance  $R_R$  varies from about 15 ohms at 21 MHz to as low as 0.1 ohm at 1.8 MHz.

For an antenna less than 0.1 wavelength long, the approximate radiation resistance may be determined from the following:

$$R_R = 273 (lf)^2 \times 10^{-8}$$

where  $l$  is the length of the whip in inches, and  $f$  is the frequency in megahertz.

Since the resistance is low, considerable current must flow in the circuit if any appreciable power is to be dissipated as radiation in the resistance  $R_R$ . Yet it is apparent that little current can be made to flow in the circuit so long as the comparatively high series reactance remains.

#### Antenna Capacitance

The capacitive reactance can be canceled out by connecting an equivalent inductive reactance,  $L_L$ , in series, as shown in Fig. 15-3, thus tuning the system to resonance.

The capacitance of a vertical antenna shorter than a quarter wavelength is given by

$$C_A = \frac{17L}{\left[ \left( \ln \frac{24L}{D} \right) - 1 \right] \left[ 1 - \left( \frac{fL}{234} \right)^2 \right]}$$

where

- $C_A$  = capacitance of antenna in pF
- $L$  = antenna height in feet
- $D$  = diameter of radiator in inches
- $f$  = operating frequency in MHz.

$$\ln \frac{24L}{D} = 2.3 \log_{10} \frac{24L}{D}$$

The graph of Fig. 15-4 shows the approximate capacitance of whip antennas of various average diameters and lengths. For 1.8, 4 and 7 MHz, the loading-coil inductance required (when the loading coil is at the base) will be approximately the inductance required to resonate in the desired band with the whip capacitance taken from the graph. For 14 and 21 MHz, this rough calculation will give more than the required inductance, but it will serve as a starting point for the final experimental adjustment that must always be made.



**Loading Coil Design**

To minimize loading-coil loss, the coil should have a high ratio of reactance to resistance, i.e., high  $Q$ . A 4-MHz loading coil wound with small wire on a small-diameter solid form of poor quality, and enclosed in a metal protector, may have a  $Q$  as low as 50, with a resistance of 50 ohms or more. High- $Q$  coils require a large conductor, "air-wound" construction, large spacing between turns, the best insulating material available, a diameter not less than half the length of the coil (not always mechanically feasible), and a minimum of metal in the field. Such a coil for 4 MHz may show a  $Q$  of 300 or more, with a resistance of 12 ohms or less.

The coil could then be placed in series with the feed line at the base of the antenna to tune out the unwanted capacitive reactance, as shown in Fig. 15-3. Such a method is often referred to as base loading, and many practical mobile antenna systems have been built in this way.

Over the years, the question has come up as to whether or not more efficient designs are possible compared with simple base loading. While many ideas have been tried with varying degrees of success, only a few have been generally accepted and incorporated into actual systems. These are center loading, continuous loading, and combinations of the latter with more conventional antennas.

Fig. 15-3 — The capacitive reactance at frequencies lower than the resonant frequency of the whip can be canceled out by adding an equivalent inductive reactance in the form of a loading coil in series with the antenna.

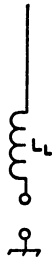

**Base Loading and Center Loading**

If a whip antenna is short compared to a wavelength and the current is uniform along the length,  $l$ , the electric field strength,  $E$ , at a distance  $d$  away from the antenna is given approximately by:

$$E = \frac{120\pi I l}{d\lambda}$$

where  $I$  is the antenna current in amperes, and  $d$  is the wavelength in the same units as  $d$  and  $l$ . A uniform current flowing along the length of the whip is an idealized situation, however, since the current is greatest at the base of the antenna and goes to a minimum at the top. In practice, the field strength will be less than that given by the above equation, being a function of the current distribution in the whip.

The reason that the current is not uniform in a whip antenna can be seen from the circuit approximation shown in Fig. 15-5. A whip antenna over a ground plane is similar in many respects to a

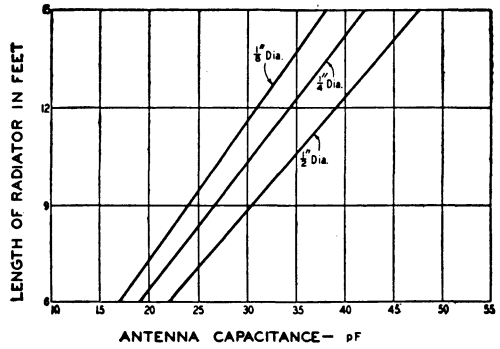

Fig. 15-4 — Graph showing the approximate capacitance of short vertical antennas for various diameters and lengths. These values should be approximately halved for a center-loaded antenna.

tapered coaxial cable where the center conductor remains the same diameter as the length increases, but with an increasing diameter of the outer conductor. The inductance per unit length of such a cable would increase farther along the line while the capacitance per unit length would decrease. In Fig. 15-5 the antenna is represented by a series of LC circuits in which  $C_1$  is greater than  $C_2$ , which is greater than  $C_3$ , and so on.  $L_1$  is less than  $L_2$ , which is less than succeeding inductances.

The net result is that most of the antenna current returns to ground near the base of the antenna, and very little near the top. Two things can be done to improve this distribution and make the current more uniform. One would be to increase the capacitance of the top of the antenna to ground through the use of top loading or a "capacitive hat," as discussed in Chapter Two. Unfortunately, the wind resistance of the hat

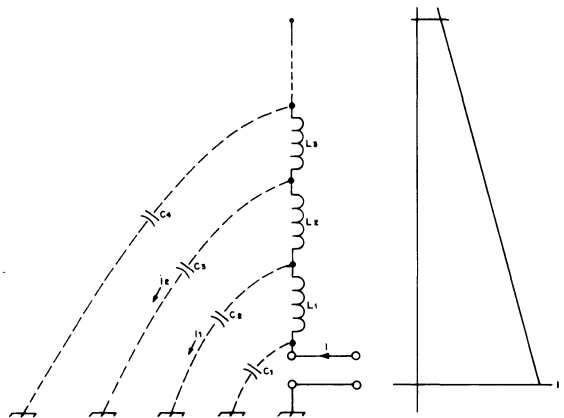

Fig. 15-5 — A circuit approximation of a simple whip over a perfectly conducting ground-plane. The shunt capacitance per unit length gets smaller as the height increases, and the series inductance per unit length gets larger. Consequently, most of the antenna current returns to the ground plane near the base of the antenna, giving the current distribution shown on the right.

Table 15-I						
Approximate Values for 8-ft. Mobile Whip						
Base Loading						
$f_{kc}$	Loading Luh.	$R_C$ (Q50) Ohms	$R_C$ (Q300) Ohms	$R_R$ Ohms	Feed $R^*$ Ohms	Matching Luh.**
1800	345	77	13	0.1	23	3
3800	77	37	6.1	0.35	16	1.2
7200	20	18	3	1.35	15	0.6
14,200	4.5	7.7	1.3	5.7	12	0.28
21,250	1.25	3.4	0.5	14.8	16	0.28
29,000	....	....	....	....	36	0.23
Center Loading						
1800	700	158	23	0.2	34	3.7
3800	150	72	12	0.8	22	1.4
7200	40	36	6	3	19	0.7
14,200	8.6	15	2.5	11	19	0.35
21,250	2.5	6.6	1.1	27	29	0.29
<p><math>R_C</math> = Loading-coil resistance; <math>R_R</math> = Radiation resistance.  * Assuming loading coil <math>Q = 300</math>, and including estimated ground-loss resistance.  ** For matching given feed resistance to 52 ohms.</p>						

makes it somewhat unwieldy for mobile use. The other method is to place the loading coil farther up the whip, as shown in Fig. 15-6, rather than at the base. If the coil is resonant (or nearly so) with the capacitance to ground of the section above the coil, the current distribution is improved as also shown in Fig. 15-6. The result with both top loading and center loading is that the radiation resistance is increased, offsetting the effect of losses and making matching easier.

Table 15-I shows the approximate loading-coil inductance for the various amateur bands. Also shown in the table are approximate values of radiation resistance to be expected with an 8-ft. whip, and the resistances of loading coils — one group having a  $Q$  of 50, the other a  $Q$  of 300. A comparison of radiation and coil resistances will show the importance of reducing the coil resistance to a minimum, especially on the three lower frequency bands.

#### Continuously Loaded Antennas

The design of high- $Q$  air-core inductors for fr work is complicated by the number of parameters which must be optimized simultaneously. One of these factors which affects coil  $Q$  adversely is radiation. Therefore, the possibility of cutting down the other losses while incorporating the coil radiation into that from the rest of the antenna system is an attractive one.

The general approach has been to use a coil made from heavy wire (No. 14 and larger), with

length-to-diameter ratios as high as 21. English experimenters have reported good results with 8-foot overall lengths on the 1.8- and 3.5-MHz bands. The idea of making the entire antenna out of one section of coil has also been tried with some success. Such antennas are referred to as helically wound. Further information on helically wound antennas is contained in Chapter Ten.

While going to extremes in trying to find a perfect loading arrangement may not improve antenna performance very much, a poor system with lossy coils and high-resistance connections is also to be avoided.

#### Matching to the Transmitter

Most modern transmitters require a 50-ohm output load and since the feed-point impedance of a mobile whip is quite low, a matching network may be necessary. While calculations are helpful in the initial design, considerable experimenting is often necessary in final tune-up. This is particularly true for the lower bands, where the antenna is electrically short compared with a quarter-wave whip. The reason is that the loading coil is required to tune out a very large capacitive reactance, and even small changes in component values result in large reactance variations. Since the feed-point resistance is low to begin with, the problem is even more aggravated. This is one reason why it is advisable to guy the antenna, and make sure that no conductors such as overhead wires are near the whip during tune-up.

Transforming the low resistance of the whip up to a value suitable for a 50-ohm system can be accomplished with an rf transformer, or with a shunt-feed arrangement, such as an *L* network. The latter may only require one extra component at the base of the whip, since the circuit of the antenna itself may be used as part of the network. The following example illustrates the calculations involved.

Assume that a center-loaded whip antenna, 8.5 feet in overall length, is to be used on 7.2 MHz. From Table 15-1, we see that the feed-point resistance of the antenna will be approximately 19 ohms, and from Fig. 15-4 that the capacitance of the whip, as seen at its base, is approximately 24 pF. Since the antenna is to be center loaded, the capacitance value of the section above the coil will be cut approximately in half, to 12 pF. From this, it may be calculated that a center-loading inductor of 40.7  $\mu$ H is required to resonate the antenna, that is, cancel out the capacitive reactance. (This figure agrees with the approximate value of 40  $\mu$ H shown in Table 15-1). The resulting feedpoint impedance would then be  $19 + j0$  ohms – a good match, if one happens to have a supply of 19-ohm coax.

Solution: The antenna can be matched to a 50-ohm line either by tuning it above or below resonance and then canceling out the undesired component with an appropriate shunt element, inductive or capacitive. The way in which the impedance is transformed up can be seen by constructing an admittance plot of the series *RLC* circuit consisting of the loading coil, antenna capacitance, and feed-point resistance. Such a plot is shown in Fig. 15-7 for a constant feed-point resistance of 19 ohms. There are two points of interest, P1 and P2, where the input conductance is 20 millimhos, which corresponds to 50 ohms.† The undesired susceptance is shown as  $1/X_p$  and  $-1/X_p$ , which must be canceled with a shunt element of the opposite sign but with the same numerical value. The value of the canceling shunt reactance,  $X_p$ , may be found from the formula:

$$X_p = \frac{R_f \cdot Z_o}{\sqrt{R_f(Z_o - R_f)}}$$

where  $X_p$  is the reactance in ohms,  $R_f$  is the feed-point resistance, and  $Z_o$  is the feed-line impedance. For  $Z_o = 50$  ohms and  $R_f = 19$  ohms,  $X_p = \pm 39.1$  ohms. A coil or good-quality mica

†The conductance equals the reciprocal of the resistance, if no reactive components are present. For a series *RX* circuit, the conductance is given by:

$$G = \frac{R}{R^2 + X^2}$$

and the susceptance is given by:

$$B = \frac{-X}{R^2 + X^2}$$

Consequently, a parallel equivalent *GB* circuit of the series *RX* one can be found which makes computations easier. This is because conductances and susceptances add in parallel the same way resistances and reactances add in series.

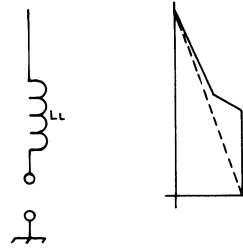

Fig. 15-6 – Improved current distribution resulting from center loading.

capacitor may be used as the shunt element. With the tune-up procedure described later, the value is not critical, and a fixed-value component may be used.

To arrive at point P1, the value of the center loading-coil inductance would be less than that required for resonance. The feed-point impedance would then appear capacitive, and an inductive shunt matching element would then be required. To arrive at point P2, the center loading coil would be more inductive than required for resonance, and the shunt element would need to be capacitive. The value of the center loading coil required for the shunt-matched and resonated condition may be determined in henrys from the equation:

$$L = \frac{1}{4\pi^2 f^2 C} \pm \frac{X_s}{2\pi f}$$

where addition is performed if a capacitive shunt is to be used, or subtraction performed if the shunt is inductive, and where  $f$  is the frequency in hertz,  $C$ , the capacitance of the antenna section being matched in farads, and  $X_s = \sqrt{R_f(Z_o - R_f)}$ .

For the example given,  $X_s$  is found to be 24.3 ohms, and the required loading inductance is either

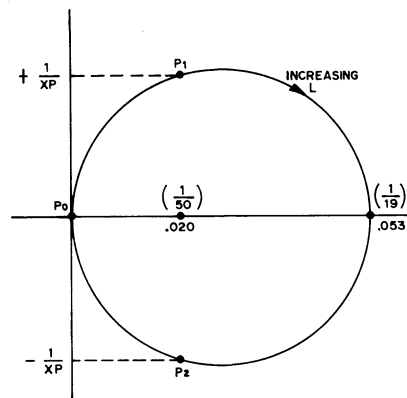

Fig. 15-7 – Admittance diagram of the *RLC* circuit consisting of the whip capacitance, radiation resistance and loading coil discussed in text. The horizontal axis represents conductance, and the vertical axis susceptance. The point P0 is the input admittance with no whip loading inductance. Points P1 and P2 are described in the text.

40.2  $\mu\text{H}$  or 41.3  $\mu\text{H}$ , depending on the type of shunt. The various matching configurations for this example are shown in Fig. 15-8. At A is shown the antenna as tuned to resonance with  $L_L$ , a 40.7- $\mu\text{H}$  coil, but with no provisions included for matching the resulting 19-ohm impedance to the 50-ohm line. At B,  $L_L$  has been reduced to 40.2  $\mu\text{H}$  to make the antenna appear capacitive, and  $L_M$ , having a reactance of 39.1 ohms, added in shunt to cancel the capacitive reactance and transform the feed-point impedance to 50 ohms. The arrangement at C is similar to that at B except that  $L_L$  has been increased to 41.3  $\mu\text{H}$ , and  $C_M$ , a shunt capacitor having a reactance of 39.1 ohms added, which also results in a 50-ohm nonreactive termination for the feed line.

The values determined for the loading coil in the above example point out an important consideration concerning the matching of short antennas — that relatively small changes in values of the loading components will have a greatly magnified effect on the matching requirements. A change of less than 3 percent in loading-coil inductance value necessitates a completely different matching network! Likewise, calculations show that a 3 percent change in antenna capacitance will give similar results, and the value of the precautions mentioned earlier becomes clear. The sensitivity of the circuit with regard to frequency variations is also quite critical and an excursion around practically the entire circle in Fig. 15-7 may represent only 600 kHz, centered around 7.2 MHz for the above example. This is why tuning up a mobile antenna can be very frustrating unless a systematic procedure is followed.

### Tune-up

Assume that inductive shunt matching is to be used with the antenna in the previous example,

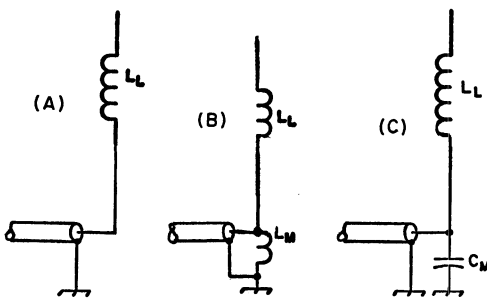
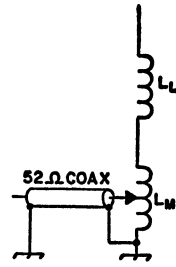

Fig. 15-8 — At A, a whip antenna which is resonated with a center loading coil. At B and C, the value of the loading coil has been altered slightly to make the feed-point impedance appear reactive, and a matching component is added in shunt to cancel the reactance. This provides an impedance transformation to match the  $Z_o$  of the feed line. An equally acceptable procedure, rather than altering the loading-coil inductance, is to adjust the length of the top section above the loading coil for the best match, as described in the tune-up section of the text.

Fig. 15-9 — A method of matching the loaded whip to 52-ohm coax cable.  $L_L$  is the loading coil and  $L_M$  the matching coil.



which means that a coil of 0.86  $\mu\text{H}$  will be placed across the whip terminals to ground. With a 40- $\mu\text{H}$  loading coil in place, the adjustable section above the loading coil should be adjusted for minimum height. Signals in the receiver will sound weak and the whip should be lengthened a bit at a time until they start to peak up. Turn the transmitter on and check the SWR at a few frequencies to find where a minimum occurs. If it is below the desired frequency of operation, shorten the whip slightly and check again. It should be moved approximately 1/4 inch at a time until the SWR is minimum at the center of the desired range. If the frequency where the minimum SWR exists is above the desired frequency, repeat the above only lengthen the whip slightly.

If a shunt capacitance is to be used, a value of 565 pF would correspond to the needed 39.1 ohms of reactance for a frequency of 7.2 MHz. With a capacitive shunt, start with the whip in its longest position and shorten it until signals peak up.

### TAPPED-COIL MATCHING NETWORK

Some of the drawbacks of the previous circuits can be eliminated by the use of the tapped-coil arrangement shown in Fig. 15-9. While tune-up is still critical, a smaller loading coil is required which cuts down losses. This system may be initially resonated with a dip meter while the feed line is disconnected. Then with the transmission line connected to a tap on  $L_M$ , listen with a receiver and adjust the tap point until the signals peak up. Next, check the SWR with a transmitter as described above. Adjust the tip length for minimum SWR at the desired frequency. Slight repositioning of the tap point on  $L_M$  may be necessary to obtain the lowest SWR.

### Bibliography

Source material and more extended discussion of topics covered in this chapter can be found in the references given below.

- Belcher, "RF Matching Techniques, Design and Example," *QST*, October, 1972.
- Belrose, "Short Antennas for Mobile Operation," *QST*, September, 1953.
- Stephens, "Admittance Matching the Ground-Plane Antenna to Coaxial Transmission Line," *Technical Correspondence, QST*, April, 1973.

# Specialized Antennas

In general, most amateur antenna installations show little departure from the standard form of either dipoles or inverted-V antennas for 80 and 40 meters, and some sort of trap-dipole or beam antenna of a triband nature for use on 20, 15 and 10 meters. This gives the hf station five-band capability without having an unsightly amount of cable and antenna hardware strewn about the premises.

Vhf antennas are, by their nature, small, and one mast can easily accommodate beams for several vhf bands. Simple vertical vhf antennas to provide access to repeaters are so unobtrusive that they can be mounted almost anywhere without being noticed.

Beyond the "standard" antenna arrangements summarized above lies an area which includes a rather large number of interesting but seldom-used antennas. These are worthy of note to experimentally inclined amateurs. This chapter will men-

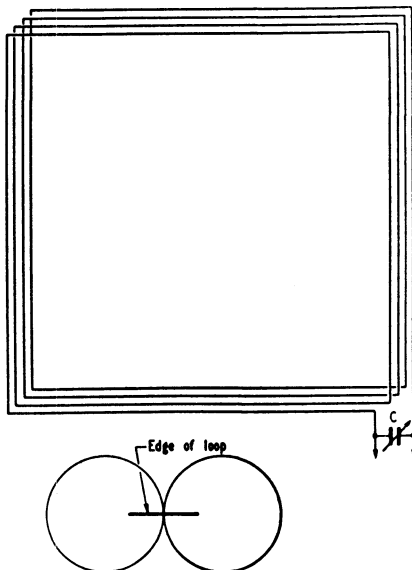

Fig. 16-1 — Small loop, consisting of several turns of wire having a total length very much less than a wavelength. The directional pattern of such a loop is as shown in the small drawing, with maximum response in the plane of the loop.

tion some of these types of antennas, including loops, special long-wire type antennas and long-wire arrays, as well as a variety of unique types of antennas which defy categorization.

## LOOP ANTENNAS

Small loops can be made in the form of a circle, triangle, rectangle, etc., with little or no change in properties. The most convenient form, generally, is a square such as is shown in Fig. 16-1. So long as the total length of the conductor is very small compared with the wavelength the loop acts like a simple inductance and can be tuned to resonance at the desired frequency by a capacitor, *C*. The directive pattern of such a loop is given by the small drawing, and is the same as that of an elementary doublet.

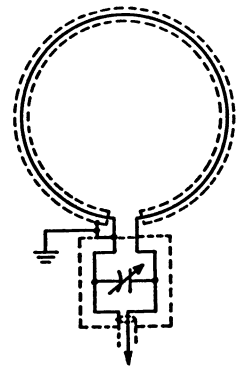

Fig. 16-2 — Shielded loop for direction finding. The ends of the shielding turn are insulated from each other to prevent shielding the loop from magnetic fields, although the shielding is effective against electric fields.

Loops of this type do not have much application in amateur work, although they are widely used at frequencies below the standard broadcast band for direction finding. They are not very useful for this purpose at high frequencies because waves arriving at a receiving point via the ionosphere have random polarization and wave angles, and this introduces large errors. However, they are capable of giving good results for this purpose if only the ground wave is present, provided the location of the loop is such that false bearings are not caused by reflections from nearby conductors. Shielded loops have been used with considerable success in "hidden transmitter hunts" utilizing frequencies 28 MHz and higher. The shield, shown schematically in Fig. 16-2, is used for preventing

“antenna effect” — that is, to eliminate undesired response of the loop considered merely as a mass of metal connected to the receiver antenna input terminals.

The radiation resistance of a small loop is extremely low. For this reason most of the power supplied to the loop is wasted in conductor resistance loss, when the loop is used for transmitting. A similar situation exists when the loop is used for receiving; because of its small size only a relatively small amount of energy is absorbed from passing waves. However, at comparatively low frequencies such as the 3.5-MHz band it can draw energy from a fairly large area (see Chapter Two on pickup efficiency) of the passing wave front and as a result may establish a reasonable signal-to-noise ratio at the receiver input terminals. It should be tuned to the received frequency in such case, and when so resonated may be markedly better than the few feet of wire often used for reception on the lower frequencies. Also, it is sometimes possible to take advantage of its directional effects to reduce interference.

Loops for the lower hf bands are generally constructed of not more than about 20 feet of wire wound into a square or circle which has a maximum dimension of from 12 to 20 inches. The response of this type of loop is bidirectional, as a dipole would be, but the gain is below that of a dipole. Loops can be made to have gain over a dipole, however, if enough wire is used so that the loop contains one-half wavelength or more. Loading coils may also be used to improve the directivity of the longer loops as shown in Fig. 2-83 and explained in its attendant text.

## SPECIALIZED LONG WIRES

### The Beverage or Wave Antenna

Nonresonant long-wire antennas were covered in Chapter Five. One version of this type of antenna is called the Beverage (or wave) antenna, and is sufficiently different to warrant space here. For one thing, unlike most antennas treated earlier in this book, the beverage requires a poorly conducting earth beneath it. This is to facilitate tilting of the approaching wave front in the vicinity of the antenna so that a larger area of the normally horizontal antenna is exposed to the wave front at any given time. The beverage antenna is essentially a long terminated transmission line, a straight

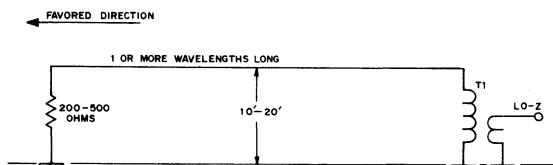

Fig. 16-3 — The Beverage (wave) antenna provides a unidirectional low-angle pattern for a very low physical height above ground. Lossy earth beneath the antenna enhances its efficiency as an antenna.

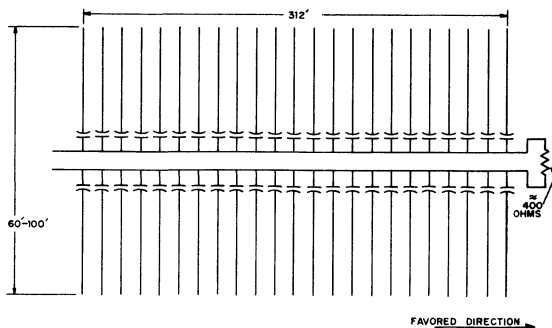

Fig. 16-4 — The fishbone antenna provides higher gain per acre than does a rhombic. It is essentially a wave antenna which evolved from the Beverage antenna.

antenna terminated at each end in its characteristic impedance. It need be only one wavelength long to be effective, and its height can be relatively low (10 to 20 feet) for a response to signals arriving at low wave angles. Depending on the condition of the ground, the antenna height, and the number of wires comprising the antenna, the characteristic impedance can be anywhere from 200 to 500 ohms. Usually it is taken to be between 500 and 600 ohms. It may be fed with open-wire transmission line or with coaxial cable through a suitable impedance matching device as shown in Fig. 16-3. If the antenna is used for transmitting, the same considerations given to termination resistance of a rhombic should be applied. The resistance power rating should be approximately one half the transmitter output power and the resistor should be noninductive.

### Fishbone Antennas

Another type of wave antenna is the fishbone, as illustrated in Fig. 16-4. The impedance of the fishbone antenna is approximately 400 ohms. The antenna is formed of closely spaced elements lightly coupled capacitively to a long, terminated, transmission line. The capacitors are chosen to have a value which will keep the velocity of propagation of the line more than 90% of that in air. The elements are usually spaced approximately 0.1 wavelength or slightly more so that an average of 7 or more elements is used for each full wavelength of transmission-line length. This antenna obtains low-angle response primarily as a function of its height, and therefore, is generally installed 60 to 120 feet above ground. If the antenna is to be used for transmission, the capacitors should be of the transmitting type, as they will be required to handle substantial current.

The English HAD fishbone antenna, shown in its two-bay form in Fig. 16-5, is of less complicated design than the one just described. It may be used singly, of course, and may be fed with 600-ohm open-wire line. Installation and operational characteristics are similar to the standard fishbone antenna.

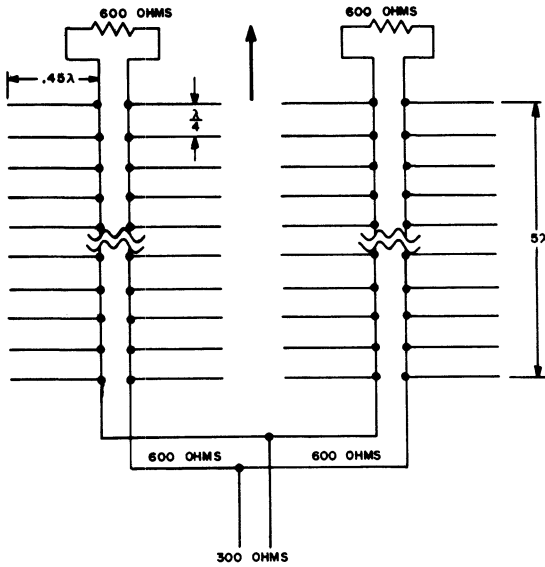

Fig. 16-5 — The English HAD fishbone antenna is a simplified version of the standard fishbone and may be used as a single-bay antenna fed with 600-ohm open-wire line.

**OTHER FORMS OF MULTIELEMENT DRIVEN ARRAYS**

Chapter Four covers the simpler forms of broadside antennas. For those who have the available room, multielement arrays based on the broadside concept have something to offer. The antennas are large but of simple design and noncritical dimensions; they are also very economical in terms of gain per unit of cost.

Three- and four-element arrays are shown in Fig. 16-6. In the 3-element array with half-wave spacing, A, the array is fed at the center. This is the most desirable point in that it tends to keep the power distribution between elements uniform. However, the transmission line could be connected at either point B or C of Fig. 16-6A, with only slight skewing of the radiation pattern.

When the spacing is greater than 1/2 wavelength, the phasing lines must be one wavelength long and are not transposed between elements. This is shown at B in Fig. 16-6. With this arrangement, any element spacing up to one wavelength can be used, if the phasing lines can be folded as suggested in the drawing.

The 4-element array at C is fed at the center of the system to make the power distribution between elements as uniform as possible. However, the transmission line could be connected at either point B, C, D or E. In such case the section of phasing line between B and D must be transposed in order to make the currents flow in the same direction in all elements. The 4-element array at C and the 3-element array at B have approximately the same gain when the element spacing in the latter is 3/4 wavelength.

An alternative feeding method is shown at D of Fig. 16-6. This system can also be applied to the 3-element arrays, and will result in better symmetry in any case. It is only necessary to move the phasing line to the center of each element, making connection to both sides of the line instead of one only.

The free-space pattern for a 4-element array with half-wave spacing is shown in Fig. 16-7. This is also approximately the pattern for a 3-element array with 3/4-wavelength spacing. The major lobe of a 3-element array with half-wave spacing is intermediate in sharpness between a 2-element array (Fig. 4-18) and a 4-element array.

Larger arrays can be designed and constructed by following the phasing principles shown in the drawings.

No accurate figures are available for the impedances at the various feed points indicated in the drawings. It can be estimated to be in the vicinity of 1000 ohms when the feed point is at a junction between the phasing line and a half-wave element, becoming smaller as the number of elements in the array is increased. When the feed point is midway between end-fed elements as in Fig. 16-6C the impedance of a 4-element array as seen by the transmission line is in the vicinity of 200 to 300

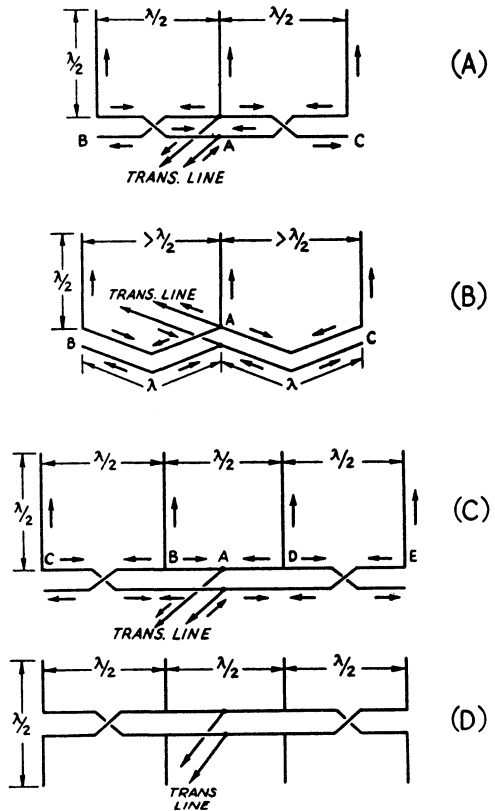

Fig. 16-6 — Methods of feeding three- and four-element broadside arrays with parallel elements.

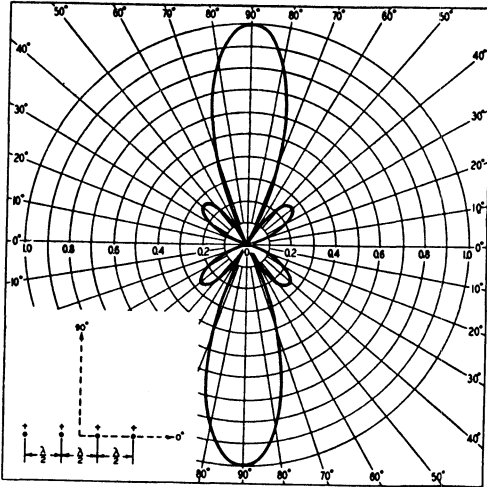

Fig. 16-7 — Free-space directive diagram of a four-element broadside array using parallel elements. This is also the horizontal directive pattern at low wave angles for a vertically polarized array.

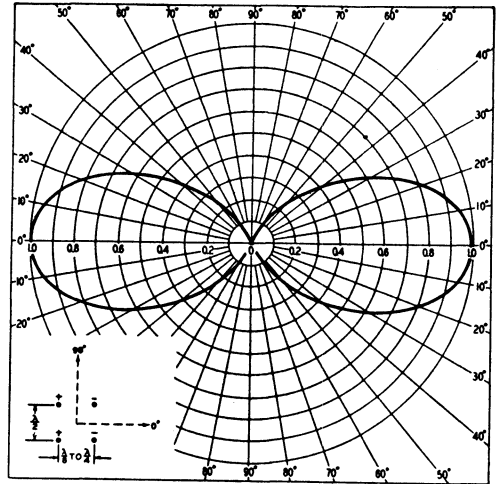

Fig. 16-9 — Free-space pattern of the four-element antenna shown in Fig. 16-8, in the plane perpendicular to the array axis. The pattern in the plane containing a set of end-fire elements is the same as Fig. 4-22 of Chapter Four.

ohms, with 600-ohm open-wire phasing lines. The impedance at the feed point with the antenna shown at D should be about 1500 ohms.

**Four-Element Broadside and End-Fire Array**

The array shown in Fig. 16-8 combines parallel elements in broadside and end-fire directivity. Approximate gains can be calculated by adding the values from Chapter Four Figs. 4-16 and 4-20 for the element spacings used. The smallest (physically) array — 3/8-wave spacing between broadside and 1/8-wave spacing between end-fire elements — has an estimated gain of 6.8 dB and the largest — 3/4- and 1/4-wave spacing, respectively — about 8.5 dB. The optimum element spacings are 5/8 wave broadside and 1/8 wave end-fire, giving an overall gain estimated at 9.3 dB. Directive patterns are given in Figs. 16-9 and 16-10.

The impedance at the feed point will not be purely resistive unless the element lengths are correct and the phasing lines are exactly a half wavelength long. (This requires somewhat less than

half-wave spacing between broadside elements.) In this case the impedance at the junction is estimated to be over 10,000 ohms. With other element spacings the impedance at the junction will be reactive as well as resistive, but in any event the standing-wave ratio will be quite large. An open-wire line can be used as a resonant line, or a matching section may be used for nonresonant operation.

**Eight-Element Driven Array**

The array shown in Fig. 16-11 is a combination of collinear and parallel elements in broadside and end-fire directivity. The gain can be calculated as described earlier, using Figs. 4-9, 4-16 and 4-20. Common practice is to use half-wave spacing for the parallel broadside elements and 1/8-wave spacing for the end-fire elements. This gives an estimated gain of about 10 dB. Directive patterns for an array using these spacings are similar to those of Figs. 16-9 and 16-10, being somewhat sharper.

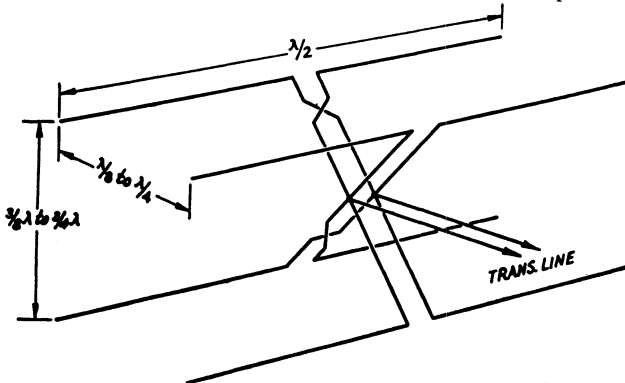

Fig. 16-8 — Four-element array combining both broadside and end-fire elements.



Although even approximate figures are not available, the SWR with this arrangement will be high. Matching stubs are recommended for making the line nonresonant. Their position and length can be determined by measuring the SWR and locating the current loop or null nearest the junction of the transmission and phasing lines. The procedure is described in Chapter Three.

This system can be used on two bands related in frequency by a 2-to-1 ratio, providing it is designed for the higher of the two with 3/4-wave spacing between the parallel broadside elements and 1/4-wave spacing between the end-fire elements. On the lower frequency it will then operate as a four-element antenna of the type shown in Fig. 16-8 with 3/8-wave broadside spacing and 1/8-wave end-fire spacing. For two-band operation a resonant transmission line must be used.

**Other Driven Systems**

Two other types of driven antennas are worthy of mention, although their use by amateurs has been rather limited. The Sterba array, shown at A in Fig. 16-12, is a broadside radiator consisting of both collinear and parallel elements, with 1/2-wave spacing between the latter. Its distinctive feature is the method of closing the ends of the system. For direct current and low-frequency ac, the system forms a closed loop, which is advantageous in that heating currents can be sent through the wires to melt the ice that forms in cold climates. There is comparatively little radiation from the vertical connecting wires at the ends because the currents are relatively small and are flowing in opposite directions with respect to the center (the voltage loop is marked with a dot in this drawing).

The system obviously can be extended as far as desired. The approximate gain is the sum of the gains of one set of collinear elements and one set of broadside elements, counting the two 1/4-wave sections at the ends as one element. The antenna shown, for example, is about equivalent to one set of four collinear elements and one set of two parallel broadside elements, so the total gain is approximately  $4.3 + 4.0 = 8.3$  dB. Horizontal polarization is the only practicable type at the lower frequencies, and the lower set of elements should be at least 1/2 wavelength above ground for best results.

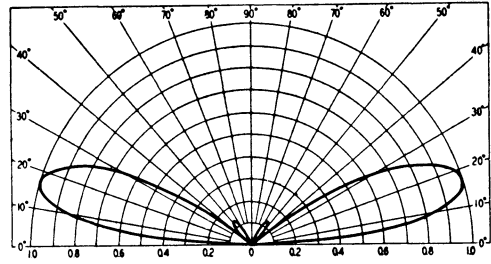

Fig. 16-10 — Vertical pattern of the antenna shown in Fig. 16-8 at a mean height of 3/4 wavelength (lowest elements 1/2 wave above ground) when the antenna is horizontally polarized. For optimum gain and low wave angle the mean height should be at least 3/4 wavelength.

When feeding at the point shown the impedance is of the order of 600 ohms. Alternatively, this point can be closed and the system fed between any two elements, as at X. In this case a point near the center should be chosen so that the power distribution between elements will be as uniform as possible. The impedance at any such point will be 1000 ohms or less in systems with six or more elements.

The Bruce array is shown at B in Fig. 16-12. It consists simply of a single wire folded so that the vertical sections carry large currents in phase while the horizontal sections carry small currents flowing in opposite directions with respect to the center (indicated by the dot). The radiation consequently is vertically polarized. The gain is proportional to the length of the array but is somewhat smaller, because of the short radiating elements, than is obtainable from a broadside array of half-wave parallel elements of the same overall length. The array should be 2 or more wavelengths long to secure a worthwhile gain. The system can be fed at any current loop; these occur at the centers of the vertical wires.

Another form of the Bruce array is shown at C. Because the radiating elements have twice the height, the gain is increased. The system can be fed at the center of any of the connecting lines.

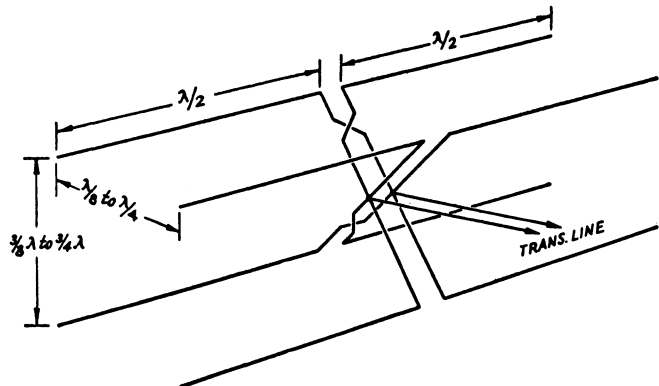

Fig. 16-11 — Eight-element driven array combining collinear and parallel elements for broadside and end-fire directivity.

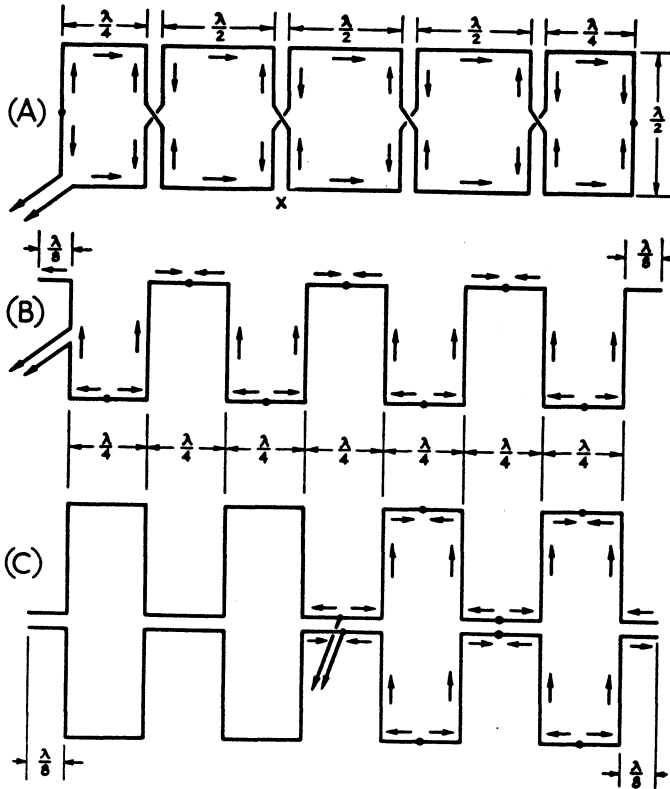

Fig. 16-12 - The Sterba array (A) and two forms of the Bruce array (B and C).

**THE DISCONE ANTENNA**

The discone is a vertically polarized broadband antenna which maintains an SWR of 1.5:1, or less, over several octaves of frequency. Fig. 16-13 shows the configuration of the antenna. Dimension  $L$  of the equilaterally skirted bottom section is approx-

imately equal to the free-space 1/4-wavelength at the lowest frequency for which the antenna is built.

Below the design frequency, the SWR rises rapidly, but within its "resonant" region the antenna provides an excellent match to the popular 50-ohm coax.

Because of its physical bulk at hf the antenna has not enjoyed much use by amateurs working in that part of the spectrum. However, the antenna has much to offer at vhf and uhf. If designed for 50 MHz, for example, the antenna will also work well on 144 and 220 MHz. Construction at hf would best be done by simulating the skirt by a grid of wires, and on vhf and uhf there would be no problem in fashioning a solid skirt of some easily workable metal, such as flashing copper.

The disk-like top-hat section should be insulated from the skirt section. This is usually done with a block of material strong enough to support

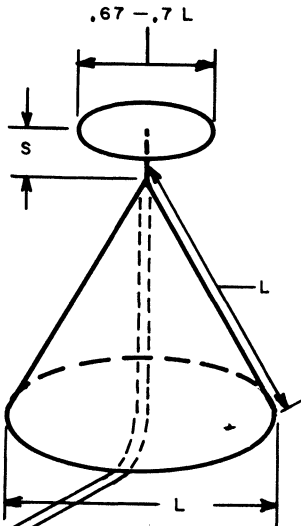

Fig. 16-13 - The discone antenna is a wideband, coaxially fed type best suited to vhf and uhf coverage because of its cumbersome size at hf. Dimension  $L$  is equal to a free-space quarter wavelength at the lowest operating frequency. The profile of the skirt is an equilateral triangle; the skirt itself can be of a cage type of construction, with adjoining wires separated by not more than  $.02\lambda$  at the bottom of the cone. Dimension  $S$  varies from 1 to 6 inches, depending on the low-frequency cutoff of the design.

50-OHM COAX

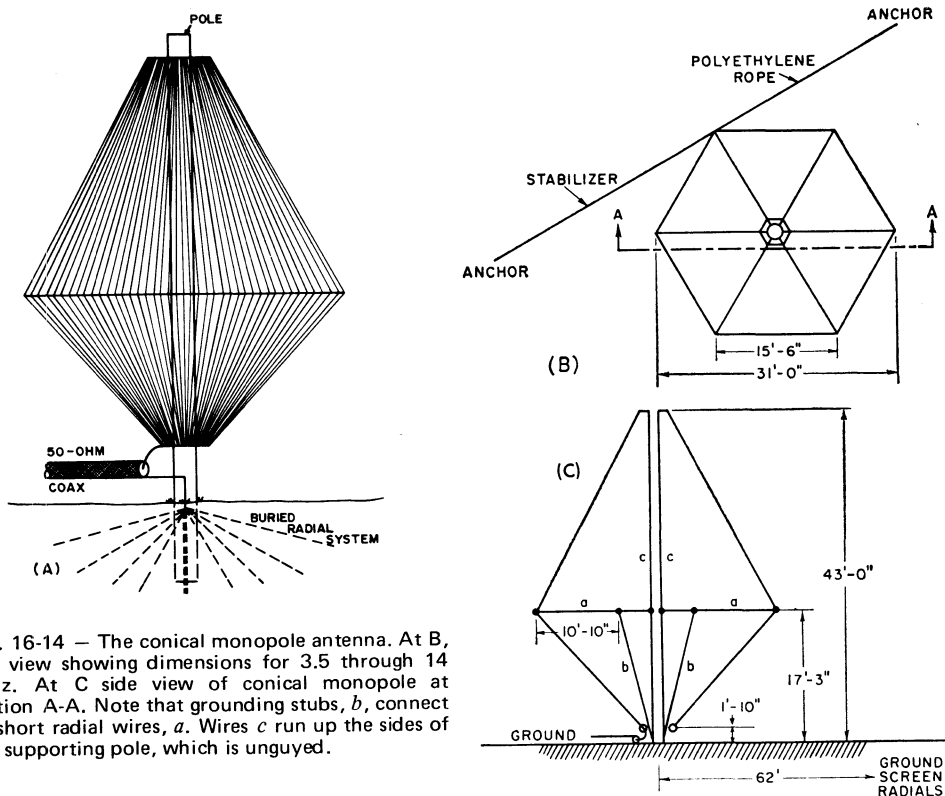

Fig. 16-14 — The conical monopole antenna. At B, top view showing dimensions for 3.5 through 14 MHz. At C side view of conical monopole at section A-A. Note that grounding stubs, *b*, connect to short radial wires, *a*. Wires *c* run up the sides of the supporting pole, which is guyed.

the disk. The inner conductor of the coax runs up through this block and is attached to the disk; the shield of the coax is connected to the skirt section.

The optimum spacing of the disk from the skirt varies as a function of the part of the spectrum for which the antenna was designed. At hf this spacing may be as much as 6 inches for 14 MHz, while at 144 MHz the spacing may be only 1 inch. It does not appear to be particularly critical.

The gain of the discone is essentially flat across its useful frequency range. The angle of radiation is very low, for the most part, rising only slightly at some frequencies.

### THE CONICAL MONOPOLE ANTENNA

A trapless vertical antenna which works well over a four-to-one frequency range and is operated at ground potential (which affords a measure of lightning protection) should appeal to users of 80 and 40 meters. Such an antenna is the conical monopole shown in Fig. 16-14. Its electrical representation is shown in Fig. 16-14C, and dimensions for operation on 80, 40 and 20 meters are given at B and C.

Whereas the length of a 1/4-wave vertical antenna for 80 meters would be in the order of 66 feet or so, the conical monopole need be only 0.17 wavelength, or 43 feet high. The foreshortening is the result of increased diameter, which also results in broadbanding. Few antennas on 80 meters will allow an operator to use both the low and high end

of the band with essentially the same low SWR; this one will.

Like vertical antennas in general, the conical monopole requires a ground system beneath it, to reduce ground losses and raise the radiation efficiency. At least 30 wires, each 62 feet long should be used. Every third radial should be connected to a ground rod at its far end and all radials should be joined at their far ends. When this much wire is involved, it behooves the builder to use galvanized steel or aluminum wire instead of copper, for economy reasons.

### THE MULTIE ANTENNA

Two-band operation may be obtained on 160 and 80 meters within the confines of the average city lot by using the multie antenna shown in Fig. 16-15. On 160 meters the top portion will do little radiating, and it acts merely as top loading for the 52-foot vertical section. On 80 meters the horizontal portion radiates and the vertical section reportedly acts as a matching stub to transform the high feed-point impedance down to a respectable match for coaxial cable.

Fig. 16-15 also gives dimensions for an 80 and 40 meter version of the multie.

Since the antenna must work against ground on its lower frequency band, it is necessary that a properly installed ground system be employed. Minimum requirements in this regard would include 20 radials, each 60 feet long. If not much

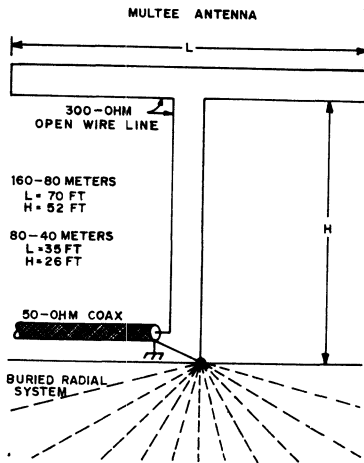

Fig. 16-15 — Two-band operation in limited space may be obtained with the multitee antenna. The feed-line portion should remain as vertical as possible, as it does the radiating on the lower frequency band.

area is available for the radial system, wires as short as 25 feet long may be used if many are installed, with some reduction in efficiency.

With suitable corrections in length to account for the velocity factor of 300-ohm TV Twin-Lead, such line may be substituted for the open-wire line, thereby eliminating a potential shock hazard to children and pets. The velocity factor should be taken into account for both the vertical and horizontal portions, to preserve the impedance relationships.

## BOBTAIL CURTAIN

The antenna system of Fig. 16-16 uses the principles of cophased verticals to produce a broadside, bidirectional pattern providing 7 to 10 dB of gain over a dipole at the same height. It is most effective for low-angle signals and makes an excellent DX antenna for either 3.5 or 7 MHz. The three vertical elements are the actual radiating components. The two horizontal parts, *A*, act as phasing lines and contribute very little to the radiation pattern. The vertical elements should be as vertical as possible. The height for the horizontal portion should be slightly greater than *B*, as shown in Fig. 16-16.

The tuning network is resonant at the operating frequency. The  $L/C$  ratio should be fairly low to provide good loading characteristics. As a starting point, a maximum value of 75 to 150 pF is recommended and the inductor value is determined by  $C$  and the operating frequency. The network is first tuned to resonance and then the tap point is adjusted for the best match. A slight readjustment of  $C$  may be necessary. As an alternative method of feeding the antenna, a link coil consisting of a few turns can be used.

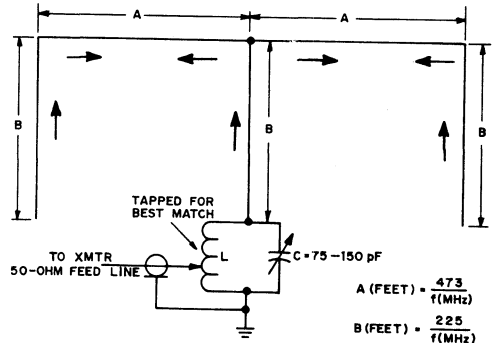

Fig. 16-16 — Bobtail curtain is an excellent low-angle radiator having broadside bidirectional characteristics. Current distribution is represented by the arrows. Dimensions *A* and *B* (in feet) can be determined by the formulas. An extensive ground system is not necessary.

## Bibliography

Source material and more extended discussion of topics covered in this chapter can be found in the references given below.

- Bailey, Dean and Wintringham, "The Receiving System for Long-Wave Transatlantic Radio Telephony," *The Bell System Technical Journal*, April, 1929.
- Beverage, "Antennas," *RCA Review*, July, 1939.
- Boyer, "Discone — 40 to 500 Mc. Skywire," *CQ*, July, 1949.
- Brown, "Directional Antennas," *Proc. I.R.E.*, January, 1937.
- Carter, Hansell and Lindenblad, "Development of Directive Transmitting Antennas by RCA Communications, Inc.," *Proc. I.R.E.*, October, 1931.
- Orr, *The Radio Handbook*, Editors and Engineers, Indianapolis, Ind.
- Pappenfus, "The Conical Monopole Antenna," *QST*, November, 1966.

# Measurements

The principal quantities to be measured on transmission lines are line current or voltage, and standing-wave ratio. Measurements of current or voltage are made for the purpose of determining the power input to the line. SWR measurements are useful in connection with the design of coupling circuits and the adjustment of the match between the antenna and transmission line, as well as in the adjustment of matching circuits.

For most practical purposes a *relative* measurement is quite sufficient. An uncalibrated indicator that shows when the largest possible amount of power is being put into the line is just as useful, in most cases, as an instrument that measures the power accurately. It is seldom necessary to know the actual number of watts going into the line unless the overall efficiency of the system is being investigated. An instrument that shows when the SWR is close to 1 to 1 is all that is needed for most impedance-matching adjustments. Accurate measurement of SWR is necessary only in studies of antenna characteristics such as bandwidth, or for the design of some types of matching systems, such as a stub match.

Quantitative measurements of reasonable accuracy demand good design and careful construction in the measuring instruments. They also require intelligent use of the equipment, including a knowledge not only of its limitations but also of stray effects that often lead to false results. A certain amount of skepticism regarding numerical data resulting from amateur measurements with simple equipment is justified until the complete conditions of the measurements are known. On the other hand, purely qualitative or relative measurements are easy to make and are quite reliable for the purposes mentioned above.

## LINE CURRENT AND VOLTAGE

A current or voltage indicator that can be used with coaxial line is a useful piece of equipment. It need not be elaborate or expensive. Its principal function is to show when the maximum power is being taken from the transmitter; for any given set of line conditions (length, SWR, etc.) this will occur when the transmitter coupling is adjusted for maximum current or voltage at the input end of the line. Although the final-amplifier plate-current meter is frequently used for this purpose, it is not

always a reliable indicator. In many cases, particularly with a screen-grid tube in the final stage, minimum loaded plate current does not occur simultaneously with maximum power output.

### RF Voltmeter

A germanium diode in conjunction with a low-range milliammeter and a few resistors can be assembled to form an rf voltmeter suitable for connecting across the two conductors of a coaxial line, as shown in Fig. 17-1. It consists of a voltage divider, R1-R2, having a total resistance about 100 times the  $Z_0$  of the line (so the power consumed will be negligible) with a diode rectifier and milliammeter connected across part of the divider to read relative rf voltage. The purpose of R3 is to make the meter readings directly proportional to the applied voltage, as nearly as possible, by "swamping" the resistance of CR1, since the latter resistance will vary with the amplitude of the current through the diode.

The voltmeter may be constructed in a small metal box, indicated by the dashed line in the

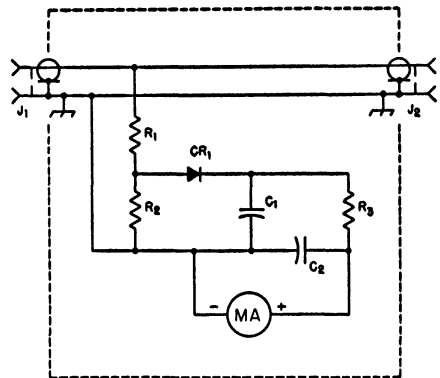

Fig. 17-1 — Rf voltmeter for coaxial line.

C1, C2 — 0.005- or 0.01- $\mu$ F ceramic.

CR1 — Germanium diode, any type.

J1, J2 — Coaxial fittings, chassis-mounting type.

MA — 0-1 milliammeter (more sensitive meter may be used if desired; see text).

R1 — 6800 ohms, composition, 1 watt for each 100 watts of rf power.

R2 — 680 ohms, 1/2 or 1 watt composition.

R3 — 10,000 ohms, 1/2 watt (see text).

drawing, fitted with coax receptacles. R1 and R2 should be composition resistors. The power rating for R1 should be 1 watt for each 100 watts of carrier power in the matched line; separate 1- or 2-watt resistors should be used to make up the total power rating required, to a total resistance as given. Any type of resistor can be used for R3; the total resistance should be such that about 10 volts dc will be developed across it at full scale. For example, a 0-1 milliammeter would require 10,000 ohms, a 0-500 microammeter would take 20,000 ohms, and so on. For comparative measurements only, R3 may be a variable resistor so the sensitivity can be adjusted for various power levels.

In constructing such a voltmeter, care should be used to prevent inductive coupling between R1 and the loop formed by R2, CR1 and C1, and between the same loop and the line conductors in the assembly. With the lower end of R1 disconnected from R2 and grounded to the enclosure, but without changing its position with respect to the loop, there should be no meter indication when full power is going through the line.

If more than one resistor is used for R1, the units should be arranged end to end with very short leads. R1 and R2 should be kept a half inch or more from metal surfaces parallel to the body of the resistor. If these precautions are observed the voltmeter will give consistent readings at frequencies up to 30 MHz. Stray capacitances and couplings limit the accuracy at higher frequencies but do not affect the utility of the instrument for comparative measurements.

### Calibration

The meter may be calibrated in rf voltage by comparison with a standard such as an rf ammeter. This requires that the line be well matched so the impedance at the point of measurement is equal to the actual  $Z_0$  of the line. Since in that case  $P = I^2 Z_0$ , the power can be calculated from the current. Then  $E = \sqrt{PZ_0}$ . By making current and voltage measurements at a number of different power levels, enough points may be secured to permit drawing a calibration curve for the voltmeter.

### RF Ammeters

An rf ammeter can be mounted in any convenient location at the input end of the transmission line, the principal precaution in its mounting being that the capacitance to ground, chassis, and nearby conductors should be low. A bakelite-

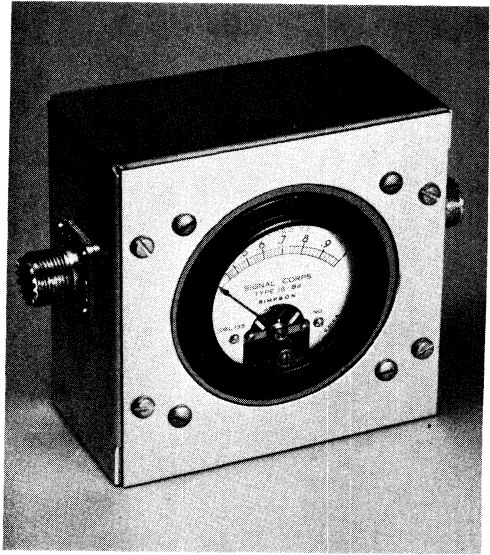

Fig. 17-2 — A convenient method of mounting an rf ammeter for use in coaxial line. This is a metal-case instrument mounted on a thin bakelite panel, the diameter of the cut-out in the metal being such as to clear the edge of the meter by about an eighth inch.

case instrument can be mounted on a metal panel without introducing enough shunt capacitance to ground to cause serious error up to 30 MHz. When installing a metal-case instrument on a metal panel it should be mounted on a separate sheet of insulating material in such a way that there is an eighth of an inch or more separation between the edge of the case and the metal.

A two-inch instrument can be mounted in a 2 × 4 × 4-inch metal box as shown in Fig. 17-2. This is a convenient arrangement for use with coaxial line.

Installed as just described, a good-quality rf ammeter will measure current with an accuracy that is entirely adequate for calculating power in the line. As discussed above in connection with calibrating rf voltmeters, the line must be closely matched by its load so the actual impedance will be resistive and equal to  $Z_0$ . The scales of such instruments are cramped at the low end, however, which limits the range of power that can be measured by a single meter. The useful current range is about 3 to 1, corresponding to a power range of about 9 to 1.

## SWR MEASUREMENTS

On parallel-conductor lines it is possible to measure the standing-wave ratio by moving a current (or voltage) indicator along the line, noting the maximum and minimum values of current (or voltage) and then computing the SWR from these measured values. This cannot be done with coaxial line since it is not possible to make measurements of this type inside the cable. The technique is, in

fact, seldom used with open lines, because it is not only inconvenient but sometimes impossible to reach all parts of the line conductors. Also, the method is subject to considerable error from antenna currents flowing on the line.

Present-day SWR measurements are practically always made with some form of "directional coupler" or rf bridge circuit. The indicator circuits

## Measurements

themselves are fundamentally simple, but considerable care is required in their construction if the measurements are to be accurate. The requirements for indicators used only for the adjustment of impedance-matching circuits, rather than actual SWR measurement, are not so stringent and an instrument for this purpose can be made quite easily.

### BRIDGE CIRCUITS

Two commonly used bridge circuits are shown in Fig. 17-3. The bridges consist essentially of two voltage dividers in parallel, with a voltmeter connected between the junctions of each pair of "arms," as the individual elements are called. When the equations shown to the right of each circuit are satisfied there is no potential difference between the two junctions, and the voltmeter indicates zero voltage. The bridge is then said to be in "balance."

Taking Fig. 17-3A as an illustration, if  $R_1 = R_2$ , half the applied voltage,  $E$ , will appear across each resistor. Then if  $R_s = R_x$ ,  $1/2 E$  will appear across each of these resistors and the voltmeter reading will be zero. Remembering that a matched transmission line has a purely resistive input impedance, suppose that the input terminals of such a line are substituted for  $R_x$ . Then if  $R_s$  is a resistor equal to the  $Z_0$  of the line, the bridge will be balanced. If the line is not perfectly matched, its input impedance will not equal  $Z_0$  and hence will not equal  $R_s$ , since the latter is chosen to equal  $Z_0$ . There will then be a difference in potential between points  $X$  and  $Y$ , and the voltmeter will show a reading. Such a bridge therefore can be used to show the presence of standing waves on the line, because the line input impedance will be equal to  $Z_0$  only when there are no standing waves.

Considering the nature of the incident and reflected components of voltage that make up the actual voltage at the input terminals of the line, as discussed in Chapter Three, it should be clear that

when  $R_s = Z_0$ , the bridge is always in balance for the incident component. Thus the voltmeter does not respond to the incident component at any time but reads only the reflected component (assuming that  $R_2$  is very small compared with the voltmeter impedance). The incident component can be measured across either  $R_1$  or  $R_2$ , if they are equal resistances. The standing wave ratio is then

$$SWR = \frac{E_1 + E_2}{E_1 - E_2}$$

where  $E_1$  is the incident voltage and  $E_2$  is the reflected voltage. It is often simpler to normalize the voltages by expressing  $E_2$  as a fraction of  $E_1$ , in which case the formula becomes

$$SWR = \frac{1 + k}{1 - k}$$

where  $k = E_2/E_1$ .

The operation of the circuit in Fig. 17-3B is essentially the same, although this circuit has arms containing reactance as well as resistance.

It is not necessary that  $R_1 = R_2$  in Fig. 17-3A; the bridge can be balanced, in theory, with any ratio of these two resistances provided  $R_s$  is changed accordingly. However, the accuracy is highest, in practice, when the two are equal, and this circuit is generally so used.

### RESISTANCE BRIDGE

The basic bridge type shown in Fig. 17-3A is recommended for home construction if a bridge is to be used for reasonably accurate SWR measurement. A practical circuit for such a bridge is given in Fig. 17-4 and a representative layout is shown in Fig. 17-5. Properly built, a bridge of this design can be used for measurement of standing-wave ratios up to about 15 to 1 with good accuracy.

Important constructional points to be observed are:

- 1) Keep leads in the rf circuit short, to reduce stray inductance.
- 2) Mount resistors two or three times their body diameter away from metal parts, to reduce stray capacitance.
- 3) Place the rf components so there is as little inductive and capacitive coupling as possible between the bridge arms.

In the layout shown in Fig. 17-5, the input and line connectors,  $J_1$  and  $J_2$ , are mounted fairly close together so the standard resistor,  $R_s$ , can be supported with short leads directly between the center terminals of the connectors.  $R_2$  is mounted at right angles to  $R_s$ , and a shield partition is used between these two components and the others.

The two 47,000-ohm resistors,  $R_5$  and  $R_6$  in Fig. 17-4, are voltmeter multipliers for the 0-100 microammeter used as an indicator. This is sufficient resistance to make the voltmeter linear (that is, the meter reading is directly proportional to the rf voltage) and no voltage calibration curve is needed.  $CR_1$  is the rectifier for the reflected voltage and  $CR_2$  is for the incident voltage. Because of resistor tolerances and small differences

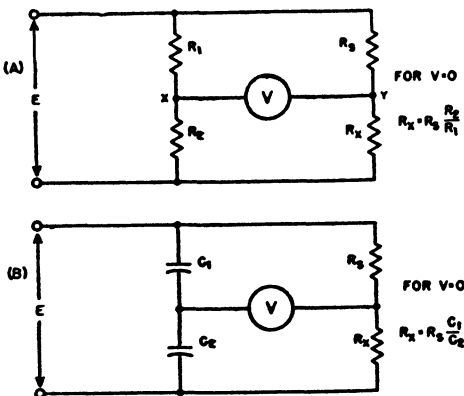

Fig. 17-3 — Bridge circuits suitable for SWR measurement. A — Wheatstone type using resistance arms. B — Capacitance-resistance bridge ("Micromatch"). Conditions for balance are independent of frequency in both types.





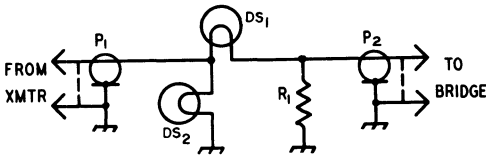

Fig. 17-6 — "Power absorber" circuit for use with resistance-type SWR bridges when the transmitter has no special provisions for power reduction. For rf powers up to 50 watts, DS1 is a 117-volt 40-watt incandescent lamp and DS2 is not used. For higher powers use sufficient additional lamp capacity at DS2 to load the transmitter to about normal output; for example, for 250 watts output DS2 may consist of two 100-watt lamps in parallel. R1 is made from three 1-watt 68-ohm resistors connected in parallel. P1 and P2 are cable-mounting coaxial connectors.

Leads in the circuit formed by the lamps and R1 should be kept short, but convenient lengths of cable may be used between this assembly and the connectors.

The circuit should pass these tests at all frequencies at which it is to be used. It is sufficient to test at the lowest and highest frequencies, usually 3.5 and 28 or 50 MHz. If R1 and R2 are poorly matched but the bridge construction is otherwise good, discrepancies in the readings will be substantially the same at all frequencies. A difference in behavior at the low and high ends of the frequency range can be attributed to stray coupling between bridge arms, or stray inductance or capacitance in the arms.

To check the bridge for balance, apply rf and adjust R4 for full scale with J2 open. Then connect a resistor identical with  $R_s$  (the resistance should match within 1 or 2 percent) to the line terminals, using the shortest possible leads. It is convenient to mount the test resistor inside a cable connector (PL-259), a method of mounting that also minimizes lead inductance. When the test resistor is connected, the reflected-voltage reading should drop to zero. The incident voltage should be reset to full scale by means of R4, if necessary. The reading should be zero at any frequency in the range to be used. If a good null is obtained at low frequencies but some residual current shows at the high end, the trouble may be the inductance of the test resistor leads, although it may also be caused by stray coupling between the arms of the bridge itself. If there is a constant low (but not zero) reading at all frequencies the cause is poor matching of the resistance values. Both effects can be present simultaneously. A good null must be obtained at all frequencies before the bridge is ready for use.

**Bridge Operation**

The rf power input to a bridge of this type must be limited to a few watts at most, because of the power-dissipation ratings of the resistors. If the transmitter has no provision for reducing power output to a very low value — less than 5 watts — a simple "power absorber" circuit can be made up as

shown in Fig. 17-6. The lamp DS1 tends to maintain constant current through the resistor over a fairly wide power range, so the voltage drop across the resistor also tends to be constant. This voltage is applied to the bridge, and with the constants given is in the right range for resistance-type bridges.

To make a measurement, connect the line to J2 and apply sufficient rf voltage to J1 to give a full-scale incident-voltage reading. R4 may be used to set to exactly full scale. Then throw S1 to the reflected-voltage position and note the meter reading. The SWR is then found by substituting the readings in the formula previously given.

For example, if the full-scale calibration of the dc instrument is 100 microamperes and the reading with S1 in the reflected-voltage position is 40 microamperes, the SWR is

$$SWR = \frac{100 + 40}{100 - 40} = \frac{140}{60} = 2.33 \text{ to } 1$$

Instead of determining the SWR value by calculations, the voltage curve of Fig. 17-7 may be used. In this example the ratio of reflected to forward voltage is  $40/100 = 0.4$ , and from Fig. 17-7 the SWR value is seen to be about 2.3 to 1.

The meter scale may be calibrated in any arbitrary units so long as the scale has equal divisions, since it is the ratios of the voltages, and not the actual values, that determine the SWR.

**Avoiding Errors in SWR Measurements**

The principal causes of inaccuracies within the bridge are differences in the resistances of R1 and R2, stray inductance and capacitance in the bridge arms, and stray coupling between arms. If the checking procedure described above is followed through carefully, the bridge of Fig. 17-4 should be amply accurate for practical use. The accuracy is highest for low standing-wave ratios because of the nature of the SWR calculation; at high ratios the divisor in the equation above represents the differ-

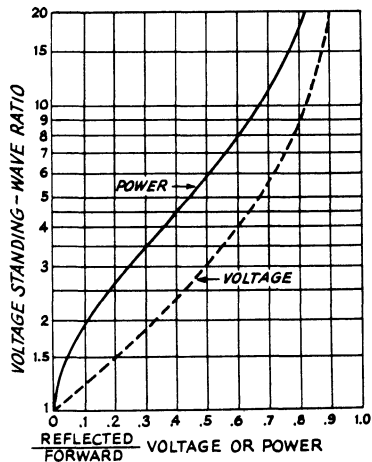

Fig. 17-7 — Chart for finding voltage standing-wave ratio when the ratio of reflected-to-forward voltage or reflected-to-forward power is known.

ence between two nearly equal quantities, so a small error in voltage measurement may mean a considerable difference in the calculated SWR.

The standard resistor  $R_s$  must equal the actual  $Z_0$  of the line. The actual  $Z_0$  of a sample of line may differ by a few percent from the nominal figure because of manufacturing variations, but this has to be tolerated. In the 50- to 75-ohm range, the rf resistance of a composition resistor of 1/2 or 1 watt rating is essentially identical with its dc resistance.

#### “Antenna” Currents

As explained in Chapter Three, there are two ways in which “parallel” or “antenna” currents can be caused to flow on the outside of a coaxial line — currents induced on the line because of its spatial relationship to the antenna, and currents that result from the direct connection between the coax outer conductor and (usually) one side of the antenna. The induced current usually will not be troublesome if the bridge and the transmitter (or other source of rf power for operating the bridge) are shielded so that any rf currents flowing on the *outside* of the line cannot find their way into the bridge. This point can be checked by “cutting in” an additional section of line (1/8 to 1/4 electrical wavelength, preferably) of the same  $Z_0$ . The SWR indicated by the bridge should not change except possibly for a slight decrease because of the additional line loss, as discussed earlier in Chapter Three. If there is a marked change, better shielding may be required.

Parallel-type currents caused by the connection to the antenna will cause a change in SWR with line length even though the bridge and transmitter are well shielded and the shielding is maintained throughout the system by the use of coaxial fittings. This is because the outside of the coax tends to become part of the antenna system, being connected to the antenna at the feed point, and so constitutes a load on the line, along with the desired load represented by the antenna itself. The SWR on the line then is determined by the composite load of the antenna and the outside of the coax, and since changing the line length changes one component of this composite load, the SWR changes too.

The remedy for such a situation is to use a good balun or to detune the outside of the line by proper choice of length. It is well to note that this is not a measurement error, since what the instrument reads is the actual SWR on the line. However, it is an undesirable condition since the line is

operating at a higher SWR than it should — and would — if the parallel-type current on the outside of the coax were eliminated.

#### Spurious Frequencies

Off-frequency components in the rf voltage applied to the bridge may cause considerable error. The principal components of this type are harmonics and low-frequency subharmonics that may be fed through the final stage of the transmitter driving the bridge. The antenna is almost always a fairly selective circuit, and even though the system may be operating with a very low SWR at the desired frequency it is practically always mismatched at harmonic and subharmonic frequencies. If such spurious frequencies are applied to the bridge in appreciable amplitude, the SWR indication will be very much in error. In particular, it may not be possible to secure a null on the bridge with any set of adjustments of the matching circuit. The only remedy is to filter out the unwanted components by increasing the selectivity of the circuits between the transmitter’s final amplifier and the bridge.

#### REFLECTOMETERS

Low-cost reflectometers which do not have a guaranteed wattmeter calibration are not ordinarily reliable for accurate numerical measurement of standing-wave ratio. They are, however, very useful as aids in the adjustment of matching networks, since the objective in such adjustment is to reduce the reflected voltage or power to zero. Relatively inexpensive devices can be used for this, since only good bridge balance is required, not actual calibration. Bridges of this type are usually “frequency-sensitive” — that is, the meter response becomes greater with increasing frequency, for the same applied voltage. When matching and line monitoring, rather than SWR measurement, is the principal use of the device, this is not a serious handicap.

Various simple reflectometers, useful for matching and monitoring, have been described from time to time in *QST* and in *The Radio Amateur’s Handbook*. Because most of these are frequency sensitive, it is difficult to calibrate them accurately for SWR measurement, but their low cost and suitability for use at moderate power levels, combined with the ability to show accurately when a matching circuit has been properly adjusted, make them a worthwhile addition to the amateur station.

#### AN IN-LINE RF WATTMETER

Considerable attention was devoted to the resistance-type SWR bridge in the preceding section because it is the simplest type that is capable of adequate accuracy in measuring voltage standing-wave ratio. Its disadvantage is that it must be operated at a very low power level, and thus is not suitable for continuous monitoring of the SWR in actual transmission. To do this the instrument

must be capable of carrying the entire power output of the transmitter, and should do it with negligible loss. An rf wattmeter meets this requirement.

It is neither costly nor difficult to build an rf wattmeter. And, if the instrument is equipped with a few additional components, it can be switched to read reflected power as well as forward power.

## Measurements

With this feature the instrument can be used as an SWR meter for antenna matching and Transmatch adjustments (see Chapters Three and Six). The wattmeter shown in Figs. 17-8 through 17-11 meets these requirements. The instrument uses a directional type of coupler for sampling the energy on the transmission line. The indicator sensitivity of this instrument is not related to frequency, as is the case with some types of directional couplers. This unit may be calibrated for power levels as low as 1 watt, full scale, in any part of the hf spectrum. With suitable calibration, it has good accuracy over the 3-30 MHz range. It is built in two parts, an rf head for inserting in the coaxial line leaving the transmitter, and a control/meter box which can be placed in any location where it can be operated conveniently. Only direct current flows in the cable connecting the two pieces.

### Design Philosophy

Referring to the circuit of Fig. 17-9, the transmission-line center conductor passes through the center of a toroid core and becomes the primary of T1. The multiturn winding on the core functions as the transformer secondary. Current flowing through the line-wire primary induces a voltage in the secondary which causes a current to flow through resistors R1 and R2. The voltage drops across these resistors are equal in amplitude, but 180 degrees out of phase with respect to common or ground. They are thus, for practical purposes, respectively in and out of phase with the line current. Capacitive voltage dividers, C1-C3 and C2-C4, are connected across the line to obtain equal-amplitude voltages *in* phase with the line voltage, the division ratio being adjusted so that these voltages match the voltage drops across R1 and R2 in amplitude. (As the current/voltage ratio in the line depends on the load, this can be done only for a particular value of load impedance. Load values chosen for this standardization are pure resistances that match the characteristic impedance of the transmission line with which the bridge is to be used, 50 or 75 ohms usually.) Under these

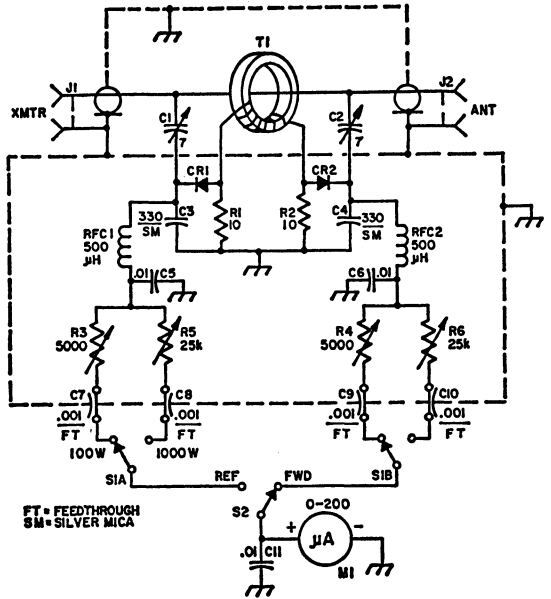

WATTS	M1	WATTS
100	200	1000
90	180	900
80	170	800
70	155	700
60	145	600
50	125	500
40	105	400
30	85	300
20	65	200
10	40	100
5	20	50

Fig. 17-9 — Schematic diagram of the rf wattmeter. A calibration scale for M1 is shown also. Fixed-value resistors are 1/2-watt composition. Fixed-value capacitors are disk ceramic unless otherwise noted. Decimal-value capacitances are in  $\mu\text{F}$ . Others are pF. Resistance is in ohms; k = 1000.

C1, C2 — 1.3- to 6.7-pF miniature trimmer (E. F. Johnson 189-502-4, available from Newark Electronics, Chicago, Ill.).

C3-C11, incl. — Numbered for circuit-board identification.

CR1, CR2 — Matched small-signal germanium diodes, 1N34A, etc. (see text).

J1, J2 — Chassis-mount coax connector of builder's choice. Type SO-239 used here.

M1 — 0 to 200- $\mu\text{A}$  meter (Triplet type 330-M used here).

R1, R2 — Matched 10-ohm resistors (see text).

R3, R4 — 5000-ohm printed-circuit carbon control (IRC R502-B).

R5, R6 — 25,000-ohm printed-circuit carbon control (IRC R252-B).

RFC1, RFC2 — 500- $\mu\text{H}$  rf choke (Millen 34300-500 or similar).

S1 — Dpdt single-section phenolic wafer switch (Mallory 3222J).

S2 — Spdt phenolic wafer switch (Centralab 1460).

T1 — Toroidal transformer; 35 turns of No. 26 enam. wire to cover entire core of Amidon T-68-2 toroid (Amidon Assoc., 12033 Otsego St., N. Hollywood, CA 91607).

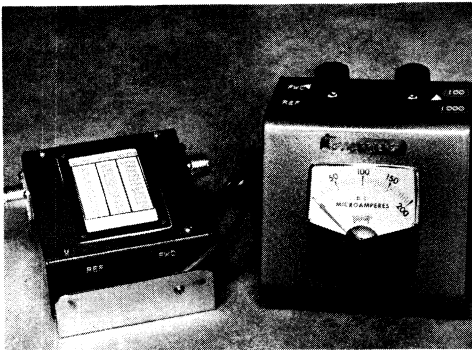

Fig. 17-8 — The rf wattmeter consists of two parts, the rf head (left), and the control/meter box (right). The paper scale affixed to the rf head contains the calibration information which appears in Fig. 17-9.

conditions, the voltages rectified by CR1 and CR2 represent, in the one case, the vector *sum* of the voltages caused by the line current and voltage, and in the other, the vector *difference*. With respect to the resistance for which the circuit has been set up, the sum is proportional to the forward component of a traveling wave such as occurs on a transmission line, and the difference is proportional to the reflected component.

### Component Selection

R1 and R2 should be selected for the best null reading when adjusting the bridge into a resistive 50- or 75-ohm load. Normally, the value will be somewhere between 10 and 47 ohms. The 10-ohm value worked well with the instruments shown here. Half-watt composition resistors are suitable to 30 MHz. R1 and R2 should be as closely matched in resistance as possible. Their exact value is not critical, so a VTVM can be used to match them.

Ideally, C3 and C4 should be matched in value. Silver-mica capacitors are usually close enough in tolerance that special selection is not required, providing there is enough leeway in the ranges of C1 and C2 to compensate for any difference in the values of C3 and C4.

Diodes CR1 and CR2 should also be matched for best results. An ohmmeter can be used to select

a pair of diodes having forward dc resistances within a few ohms of being the same. Similarly, the back resistances of the diodes can be matched. The matched diodes will help to assure equal meter readings when the bridge is reversed. (The bridge should be perfectly bilateral in its performance characteristics.) Germanium diodes should be used to avoid misleading results when low values of reflected power are present during antenna adjustments. The SWR can appear to be zero when actually it isn't. The germanium diodes conduct at approximately 0.3 volt, making them more suitable for low-power readings than silicon diodes.

Any meter having a full-scale reading between 50 microamperes and 1 milliampere can be used at M1. The more sensitive the meter, the more difficult it will be to get an absolute reflected-power reading of zero. Some residual current will flow in the bridge circuit no matter how carefully the circuit is balanced, and a sensitive instrument will detect this current flow. Also, the more sensitive the meter, the larger will have to be the calibrating resistances, R3 through R6, to provide high-power readings. A 0 to 200-microampere meter represents a good compromise for power ranges between 100 and 2000 watts.

### Construction

It is important that the layout of any rf bridge be as symmetrical as possible if good balance is to be had. The circuit-board layout for the instrument of Fig. 17-11 meets this requirement. The input and output ports of the equipment should be isolated from the remainder of the circuit so that only the sampling circuits feed voltage to the bridge. A shield across the end of the box which contains the input and output jacks, and the interconnecting line between them, is necessary. If stray rf gets into the bridge circuit it will be impossible to obtain a complete zero reflected-power reading on M1 even though a 1:1 SWR exists.

All of the rf-head components except J1, J2 and the feedthrough capacitors are assembled on the board. It is held in place by means of a homemade aluminum L bracket at the end nearest T1. The circuit-board end nearest the feedthrough capacitors is secured with a single No. 6 spade bolt. Its hex nut is outside the box, and is used to secure a solder lug which serves as a connection point for the ground braid in the cable which joins the control box to the rf head.

T1 fits into a cutout area of the circuit board. A 1-inch long piece of RG-8/U coax is stripped of its vinyl jacket and shield braid, and is snug-fit into the center hole of T1. The inner conductor is soldered to the circuit board to complete the line-wire connection between J1 and J2.

The upper dashed lines of Fig. 17-9 represent the shield partition mentioned above. It can be made from flashing copper or thin brass.

The control box, a sloping-panel utility cabinet measuring 4 × 5 inches, houses S1 and S2, and the meter, M1. Four-conductor shielded cable – the shield serving as the common lead – is used to join the two pieces. There is no reason why the entire

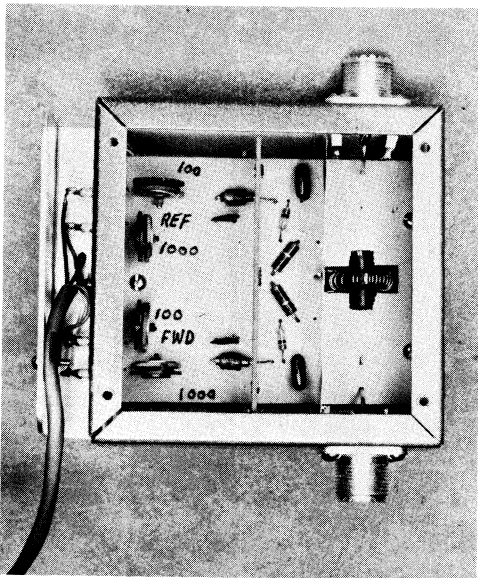

Fig. 17-10 – Top view of the rf head for the circuit of Fig. 17-9. A flashing-copper shield isolates the primary rf line and T1 from the rest of the circuit. The second shield (thicker) is not required and can be eliminated from the circuit. If a 2000-watt scale is desired, fixed-value resistors of approximately 22,000 ohms can be connected in series with high-range printed-circuit controls. Or, the 25,000-ohm controls shown here can be replaced by 50,000-ohm units.

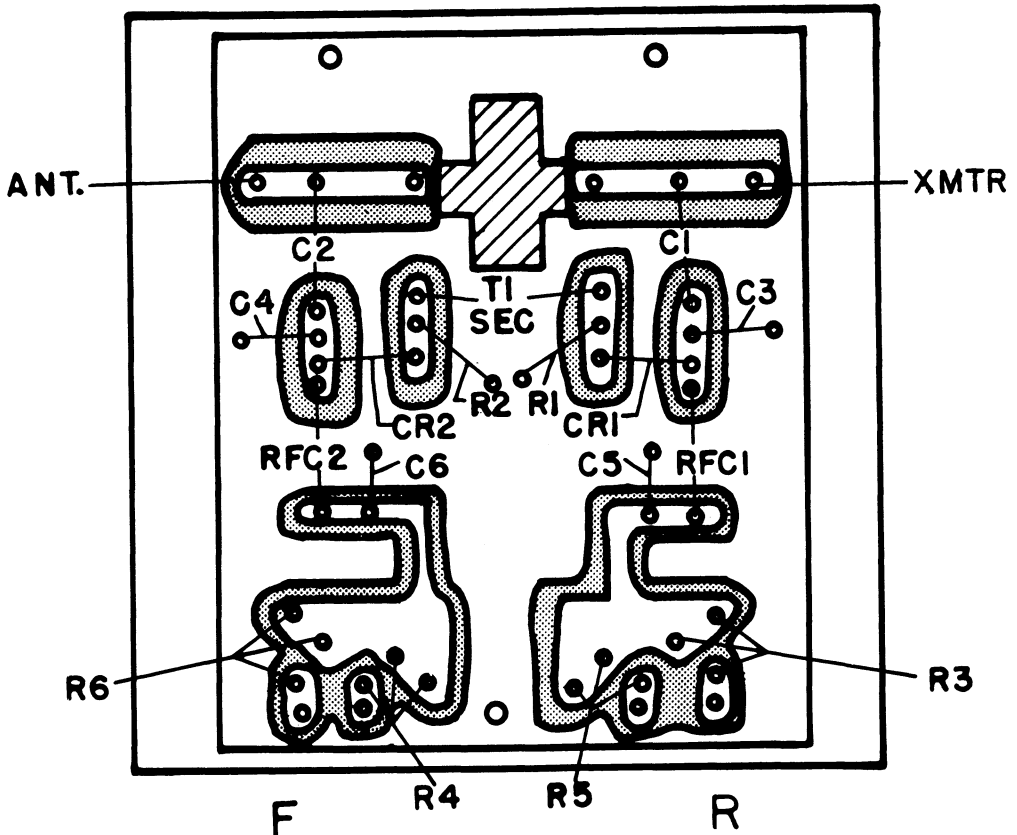

Fig. 17-11 — Etching pattern and parts layout for the rf wattmeter, as seen from the foil side of the board. The etched-away portions of the foil are shown as darkened areas in this drawing. The area represented with diagonal lines is to be cut out for the mounting of T1.

instrument cannot be housed in one container, but it is sometimes awkward to have coaxial cables attached to a unit that occupies a prominent place in the operating position. Built as shown, the two-piece instrument permits the rf pickup head to be concealed behind the transmitter, while the control head can be mounted where it is accessible to the operator.

#### Adjustment

Perhaps the most difficult task faced by the constructor is that of calibrating the power meter for whatever wattage range he desires to have. The least difficult method is to use a commercial wattmeter as a standard. If one is not available, the power output of the test transmitter can be computed by means of an rf ammeter in series with a 50-ohm dummy load, using the standard formula,  $P = I^2 R$ . The calibration chart of Fig. 17-9 is representative, but the actual calibration of a particular instrument will depend upon the diodes used at CR1 and CR2. Frequently, individual scales are required for the two power ranges.

Connect a noninductive 50-ohm dummy load to J2. A Heath Antenna or similar load will serve nicely for adjustment purposes. Place S2 in the

FORWARD position, and set S1 for the 100-watt range. An rf ammeter or calibrated power meter should be connected between J2 and the dummy load during the tests, to provide power calibration points against which to plot the scale of M1. Apply transmitter output power to J1, gradually, until M1 begins to deflect upward. Increase transmitter power and adjust R4 so that a full-scale meter reading occurs when 100 watts is indicated on the rf ammeter or other standard in use. Next, switch S2 to REFLECTED and turn the transmitter off. Temporarily short across R3, turn the transmitter on, and gradually increase power until a meter reading is noted. With an insulated screwdriver adjust C2 for a null in the meter reading.

The next step is to reverse the coax connections to J1 and J2. Place S2 in the REFLECTED position and apply transmitter power until the meter reads full scale at 100 watts output. In this mode the REFLECTED position actually reads forward power because the bridge is reversed. Calibrating resistance R3 is set to obtain 100 watts full scale during this adjustment. Now, switch S2 to FORWARD and temporarily place a short across R4. Adjust C1 for a null reading on M1. Repeat the foregoing steps until no further improvement can

be obtained. It will not be necessary to repeat the nulling adjustments on the 1000-watt range, but R5 and R6 will have to be adjusted to provide a full-scale meter reading at 1000 watts. If insufficient meter deflection is available for nulling adjustments on the 100-watt range, it may be necessary to adjust C1 and C2 at some power level higher than 100 watts. If the capacitors tune through a null, but the meter will not drop all the way to zero, chances are that some rf is leaking into the bridge circuit through stray coupling. If so, it may be necessary to experiment with the shielding of the through-line section of the rf head. If only a small residual reading is noted it will be of minor importance and can be ignored.

With the component values given in 17-9, the meter readings track for both power ranges. That is, the 10-watt level on the 100-watt range, and the 100-watt point on the 1000-watt range, fall at the same place on the meter scale, and so on. This no doubt results from the fact that the diodes are conducting in the most linear portion of their curve. Ordinarily, this desirable condition does not exist, making it necessary to plot separate scales for the different power ranges.

Tests indicate that the SWR caused by insertion of the power meter in the transmission line is negligible. It was checked at 28 MHz and no

reflected power could be noted on a commercially built rf wattmeter. Similarly, the insertion loss was so low that it could not be measured with ordinary instruments.

### Operation

It should be remembered that when the bridge is used in a mismatched feed line that has not been properly matched at the antenna, a reflected-power reading will result. The reflected power must be subtracted from the forward power to obtain the actual power output. If the instrument is calibrated for, say, a 50-ohm line, the calibration will not hold for other values of line  $Z_0$ .

If the instrument is to be used for determining SWR, the reflected/forward power ratio can easily be converted into the corresponding voltage ratio for use in the formula given earlier. Since power is proportional to voltage squared, the normalized formula becomes

$$VSWR = \frac{1 + \sqrt{k}}{1 - \sqrt{k}}$$

where  $k$  is the ratio of reflected power to forward power. The *power* curve of Fig. 17-7 is based on the above relationship, and may be used in lieu of the equation to determine the SWR.

## AN INEXPENSIVE VHF DIRECTIONAL COUPLER

Precision in-line metering devices that are capable of reading forward and reflected power over a wide range of frequencies are very useful in amateur vhf and uhf work, but their rather high cost puts them out of the reach of many vhf enthusiasts. The device shown in Figs. 17-12 through 17-15 is an inexpensive adaptation of their basic principles. It can be made for the cost of a meter, a few small parts, and bits of copper pipe and fittings that can be found in the plumbing stocks at many hardware stores.

### Construction

The sampler consists of a short section of hand-made coaxial line, in this instance of 50 ohms impedance, with a reversible probe coupled to it. A small pickup loop built into the probe is terminated with a resistor at one end and a diode at the other. The resistor matches the impedance of the

loop, not the impedance of the line section. Energy picked up by the loop is rectified by the diode, and the resultant current is fed to a meter equipped with a calibration control.

The principal metal parts of the device are a brass plumbing T, a pipe cap, short pieces of 3/4-inch ID and 5/16-inch OD copper pipe, and two coaxial fittings. Other available tubing combinations for 50-ohm line may be usable. The ratio of outer-conductor ID to inner-conductor OD should be 2.4/1. For a sampler to be used with other impedances of transmission line, see Chapter Three for suitable ratios of conductor sizes. The photographs and Fig. 17-14 show construction details.

Soldering of the large parts can be done with a 300-watt iron or a small torch. A neat job can be done if the inside of the T and the outside of the pipe are tinned before assembling. When the pieces are reheated and pushed together, a good mechan-

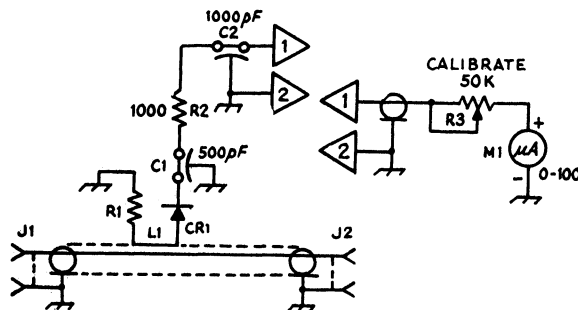

Fig. 17-12 — Circuit diagram for the line sampler. C1 — 500-pF feedthrough capacitor, solder-in type. C2 — 1000-pF feedthrough capacitor, threaded type.

CR1 — Germanium diode 1N34, 1N60, 1N270, 1N295, or similar.

J1, J2 — Coaxial connector, type N (UG-58A/U). L1 — Pickup loop, copper strap 1-inch long X 3/16-inch wide. Bend into "C" shape with flat portion 5/8-inch long.

M1 — 0-100- $\mu$ A meter.

R1 — Composition resistor, 82 to 100 ohms. See text.

R3 — 50,000-ohm composition control, linear taper.

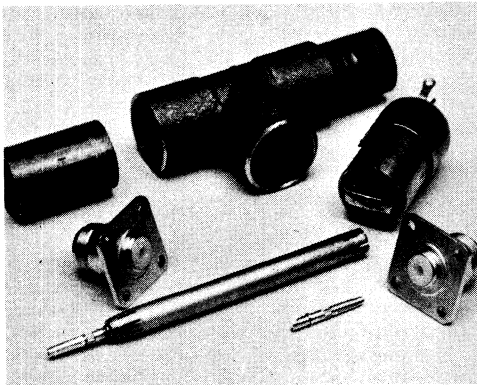

Fig. 17-13 — Major components of the line sampler. The brass T and two end sections are at the rear in this picture. A completed probe assembly is at the right. The N connectors have their center pins removed. The pins are shown with one inserted in the left end of the inner conductor and the other lying in the right foreground.

ical and electrical bond will result. If a torch is used, go easy with the heat, as an over-heated and discolored fitting will not accept solder well.

Coaxial connectors with Teflon or other heat-resistant insulation are recommended. Type N, with split-ring retainers for the center conductors, are preferred. Pry the split-ring washers out with a knife point or small screwdriver. Don't lose them, as they'll be needed in the final assembly.

The inner conductor is prepared by making eight radial cuts in one end, using a coping saw with a fine-toothed blade, to a depth of 1/2 inch. The fingers so made are then bent together, forming a tapered end, as shown in Figs. 17-13 and 17-14. Solder the center pin of a coaxial fitting into this, again being careful not to overheat the work.

In preparation for soldering the body of the coax connector to the copper pipe, it is convenient

to use a similar fitting clamped into a vise as a holding fixture, with the T assembly resting on top, held in place by its own weight. Use the partially prepared center conductor to assure that the coax connector is concentric with the outer conductor. After being sure that the ends of the pipe are cut exactly perpendicular to the axis, apply heat to the coax fitting, using just enough so that a smooth fillet of solder can be formed where the flange and pipe meet.

Before completing the center conductor, check its length. It should clear the inner surface of the connector by the thickness of the split ring on the center pin. File to length; if necessary, slot as with the other end, and solder the center pin in place. The fitting can now be soldered onto the pipe, to complete the 50-ohm line section.

The probe assembly is made from a 1-1/2-inch length of the copper pipe, with a pipe cap on the top to support the upper feedthrough capacitor, C2. The coupling loop is mounted by means of small Teflon standoffs on a copper disk, cut to fit inside the pipe. The disk has four small tabs around the edge for soldering inside the pipe. The diode, CR1, is connected between one end of the loop and a 500-pF feedthrough capacitor, C1, soldered into the disk. The terminating resistor, R1, is connected between the other end of the loop and ground, as directly as possible.

When the disk assembly is completed, insert it into the pipe, apply heat to the outside, and solder the tabs in place by melting solder into the assembly at the tabs. The position of the loop with respect to the end of the pipe will determine the sensitivity of a given probe. For power levels up to 200 watts the loop should extend beyond the face of the pipe about 5/32 inch. For use at higher power levels the loop should protrude only 3/32 inch. For operation with very low power levels the best probe position can be determined by experiment.

The decoupling resistor, R2, and feedthrough capacitor, C2, can be connected, and the pipe cap put in place. The threaded portion of the capacitor extends through the cap. Put a solder lug over it before tightening its nut in place. Fasten the cap with two small screws that go into threaded holes in the pipe.

Calibration

The sampler is very useful for many jobs, even if it is not accurately calibrated, although it is desirable to calibrate it against a wattmeter of

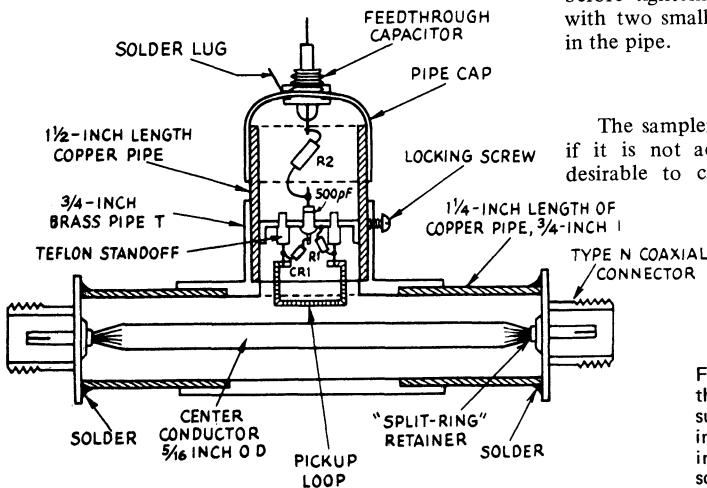

Fig. 17-14 — Cross-section view of the line sampler. The pickup loop is supported by two Teflon standoff insulators. The probe body is secured in place with one or more locking screws through holes in the brass T.

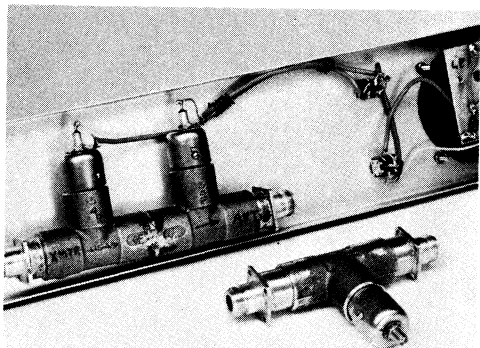

Fig. 17-15 — Two versions of the line sampler. The single unit described in detail here is in the foreground. Two sections in a single assembly provide for monitoring forward and reflected power without probe reversal.

known accuracy. A good 50-ohm dummy load is required.

The first step is to adjust the inductance of the loop or the value of the terminating resistor, for lowest reflected-power reading. The loop is the easier to change. Filing it to reduce its width will increase its impedance. Increasing the cross-section of the loop will lower it, and this can be done by coating it with solder. When the reflected-power reading is reduced as far as possible, reverse the probe and calibrate for forward power by increasing the transmitter power output in steps and making a graph of the meter readings obtained. Use the calibration control, R3, to set the maximum reading.

## RF IMPEDANCE BRIDGE FOR COAX LINES

The bridge shown in Fig. 17-16, dubbed the "Macromatcher," may be used to measure unknown complex impedances. Measured values are of equivalent series form,  $R + jX$ . With suitable frequency coils, the Macromatcher can be used throughout the frequency range 1.8 to 30 MHz. The useful impedance range of the instrument is from about 5 to 400 ohms if the unknown load is purely resistive, or 10 to 150 ohms resistive component in the presence of appreciable reactance. The reactance range is from 0 to approximately 100 ohms for either inductive or capacitive loads. Although the Macromatcher cannot indicate impedances with the accuracy of a laboratory bridge, its readings are quite adequate for most amateur uses, including the taking of line lengths into account with a Smith Chart. By inherent properties of the Macromatcher, its accuracy is best at the centers of the dial calibration ranges.

### The Basic Bridge Circuit

The basic circuit of the Macromatcher is that of Fig. 17-3B. If C1 and C2 of that circuit are the sections of a differential capacitor, the bridge may be used over a wide impedance range, rather than

### Variations

Rather than use one sampler for monitoring both forward and reflected power by repeatedly reversing the probe, it is better to make two assemblies by mounting two T fittings end-to-end, using one for forward and one for reflected power. The meter can be switched between the probes, or two meters can be used.

The sampler described was calibrated at 146 MHz, as it was intended for 2-meter repeater use. On higher bands the meter reading will be higher for a given power level, and it will be lower for lower frequency bands. Calibration for two or three adjacent bands can be achieved by making the probe depth adjustable, with stops or marks to aid in resetting for a given band. And, of course, more probes can be made, with each calibrated for a given band, as is done in some of the commercially available units.

Other sizes of pipe and fittings can be used by making use of information given in Chapter Three to select conductor sizes required for the desired impedances. (Since it is occasionally possible to pick up good bargains in 72-ohm line, a sampler for this impedance might be desirable.)

Type N fittings were used because of their constant impedance, and their ease of assembly. Most have the split-ring retainer, which is simple to use in this application. Some have a crimping method, as do apparently all BNC connectors. If a fitting must be used that cannot be taken apart, drill a hole large enough to clear a soldering-iron tip in the copper-pipe outer conductor. A hole of up to 3/8-inch diameter will have very little effect on the operation of the sampler.

for a single fixed impedance. A variable ratio in the C1-C2 arms is provided by two identical capacitor sections on the same frame, arranged so that when the shaft is rotated to increase the capacitance of one section, the capacitance of the other section decreases. With a fixed value for  $R_s$ , the settings of the capacitor may be calibrated in terms of resistance at  $R_x$ .

The circuit of Fig. 17-3B is modified slightly for use in the Macromatcher, as shown in Fig. 17-17. The differential capacitor is retained for C1 and C2 to measure resistance. L1 and C3 have been added in series in the "unknown" arm of the bridge, and it is these components which are used to measure the amount and type of reactance at the unknown load. (Both L1 and C3 are adjustable in the actual bridge circuit.) The Macromatcher is initially balanced at the frequency of measurement with a pure resistance in place of R2, Fig. 17-17, so that the reactances of L1 and of C3 at its midsetting are equal. Thus, these reactances cancel each other in this arm of the bridge, and no reactance is reflected into the remaining bridge arms. For measurement, an unknown complex-impedance load is then connected into the bridge



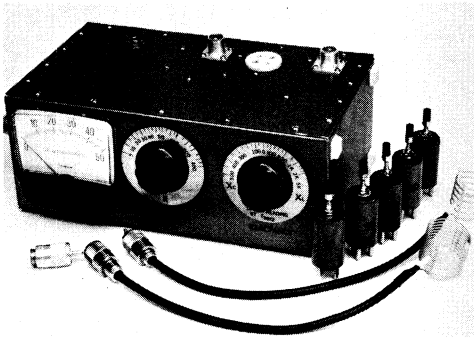

Fig. 17-16 — An RCL bridge for measuring unknown values of complex impedances. A plug-in coil is used for each frequency band. The bridge operates at an rf input level of about 5 volts; pickup-link assemblies for use with a grid-dip oscillator are shown. Before measurements are made, the bridge must be balanced with a non-reactive load connected at its measurement terminals. This load consists of a resistor mounted inside a coaxial plug, shown in front of the instrument at the left. The aluminum box measures 4-1/4 × 10-3/4 × 6-1/8 inches and is fitted with a carrying handle on the left end and self-sticking rubber feet on the right end and bottom. Dials are Millen No. 10009 with skirts reversed and calibrations added.

in place of R2. The resistive component of the load is balanced by varying the C1-C2 ratio. The reactive component is balanced by varying C3 either to increase or decrease its capacitive reactance, as required, to cancel any reactance present in the load. If the load is inductive, more capacitive reactance (less capacitance) is required from C3 to obtain a balance. Less reactance (more capacitance) is needed from C3 if the load is capacitive. The end result, after C3 is properly adjusted for the particular unknown load, is that the overall R2 arm of the bridge again looks purely resistive, and a complete null is obtained on the null detector.

The settings of C3 are calibrated in terms of the value and type of reactance at the load terminals. Because of the relationship of capacitive reactance to frequency, the calibration for the dial of the reactance-measuring capacitor is valid at only one frequency. It is therefore convenient to calibrate this dial for equivalent reactances at 1 MHz. Frequency corrections may then be made simply

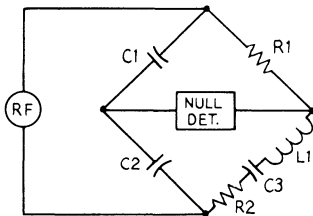

Fig. 17-17 — The basic circuit of the Macro-matcher. In this circuit the bridge is balanced before measurements are made, by setting  $X_{L1} = X_{C3}$ .

by dividing the reactance dial reading by the measurement frequency in megahertz.

Fig. 17-18 is the complete schematic diagram of the Macro-matcher. C1 is the resistance-measuring capacitor, and L1 and C2 the reactance-measuring components. R1 is the bridge "standard" resistor. Aside from the INPUT and OUTPUT jacks and J2, the connector for L1, all other parts are associated with the null-detector metering section of the circuit. This portion of the circuit is adopted from that of the resistance bridge described earlier in this chapter, and the discussion and precautions which pertain to that instrument in general apply here, as well.

CR1 rectifies rf energy present when the bridge is unbalanced, and this energy is filtered into direct current which is metered at M1. The 12-kΩ resistor provides a high-impedance input for the metering circuit, and the 4700-ohm resistor at J1 provides a return path for meter-current flow if the input source is capacitance coupled. J4 is for the connection of an external meter, in the event it is desired to observe readings remotely. CR2, placed directly across M1, protects the meter from over-current surges. Although it appears from the schematic diagram that this germanium diode will shunt out all meter current, such is not the case in actual operation because approximately 250 millivolts must be developed across the diode before it

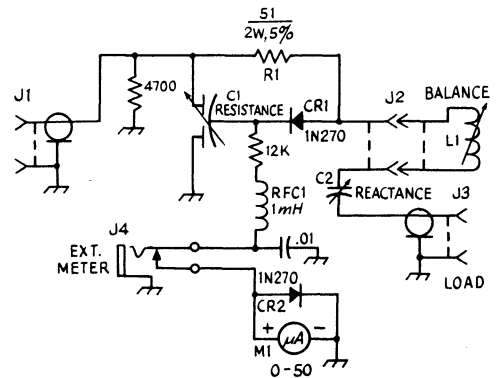

Fig. 17-18 — Schematic diagram of the Macro-matcher. Capacitance is in microfarads; resistance is in ohms, k = 1000. Resistors are 1/2-W 10-percent tolerance unless otherwise indicated.

- C1 — Differential capacitor, 11-161 pF per section (Millen 28801 or Jackson Bros. C702/5301 suitable).
- C2 — 17.5-327 pF with straight-line capacitance characteristic (Millen 19335 or Jackson Bros. C9/5070 suitable).
- CR1, CR2 — Germanium diode, high back resistance.
- J1, J3 — Coaxial connector, chassis type.
- J2 — To mate plug of L1, ceramic.
- J4 — Phone jack, closed-circuit type.
- L1 — See text and Table 17-1.
- M1 — 0-50 μA dc (Simpson Model 1223 Bold-vue, Cat. No. 15560 used here).
- R1 — For text reference.
- RFC1 — Subminiature rf choke (Miller 70F103A1 or equiv.).

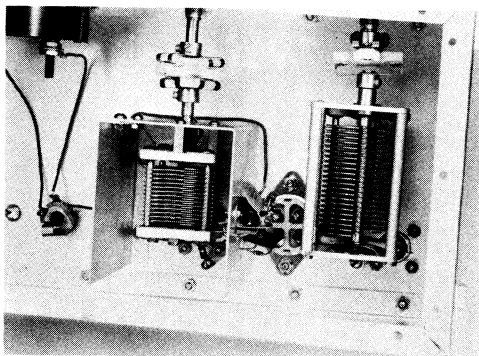

Fig. 17-19 — All components except the meter are mounted on the top of the box. C1 is visible inside the homemade shield at the left, with C2 at the right and J2 mounted between them. J1 is hidden beneath C1 in this view; a part of J3 may be seen in the lower right corner of the box. Components for the dc metering circuit are mounted on a tie-point strip which is affixed to the shield wall for C1; all other components are interconnected with very short leads. The 4700-ohm input resistor is connected across J1. This photograph was made before the diode was connected across the terminals of M1.

begins to conduct an appreciable amount of current. The internal resistance of a typical 50- $\mu$ A meter is 1800 or 2000 ohms, and this means that more than 100  $\mu$ A of current must be flowing through the meter before the diode shunting effect becomes appreciable. In operation, this diode prevents the meter needle from slamming against the peg if the load is disconnected while input rf excitation is still applied; the needle eventually reaches full scale, but travels more slowly with the diode in the circuit.

#### Construction

In any rf-bridge type of instrument, the leads must be kept as short as possible to reduce stray

reactances. Placement of component parts, while not critical, must be such that lead lengths greater than about 1/2 inch (except in the dc metering circuit) are avoided. Shorter leads are desirable, especially for R1, the standard resistance for the bridge. In the unit photographed, the body of this resistor just fits between the terminals of C1 and J2 where it is connected. C1 should be enclosed in a shield and connections made with leads passing through holes drilled through the shield wall. The frames of both variable capacitors, C1 and C2, must be insulated from the chassis, such as on ceramic pillars, with insulated couplings used on the shafts. As Fig. 17-19 indicates, all parts of the bridge except the meter and the calibrated dials are mounted on the top panel of the box. The dials are front-panel mounted on shafts with panel bearings.

Band-switching arrangements for L1 complicate the construction and contribute to stray reactances in the bridge circuit. For these reasons plug-in coils are used at L1, one coil for each band over which the instrument is used. The coils must be adjustable, to permit initial balancing of the bridge with C2 set at the zero-reactance calibration point. Coil data are given in Table 17-I. Millen 45004 coil forms, with the coils supported inside, provide a convenient method of constructing these slug-tuned plug-in coils. A phenolic washer cut to the proper diameter is epoxied to the top or open end of each form, giving a rigid support for mounting of the coil by its bushing. Small knobs for 1/8-inch shafts, threaded with a No. 6-32 tap, are screwed onto the coil slug-tuning screws to permit ease of adjustment without a tuning tool. Knobs with setscrews should be used to prevent slipping. A ceramic socket to mate with the pins of the coil form is used for J2.

#### A Nonreactive Termination

For calibrating the reactance dial and for initially balancing the Macromatcher each time it is used on a new frequency, a purely resistive load is required for connection at J3. A suitable load

TABLE 17-I — COIL DATA FOR RF IMPEDANCE BRIDGE

Band	Nominal Inductance Range, $\mu$ H	Frequency Coverage, MHz	Coil Type or Data
160	27.5-58	1.6-2.3	Miller 42A475CBI.
80	6.5-13.8	3.2-4.8	28 turns No. 30 enam. wire close-wound on Miller form 42A000CBI.
40	2.0-4.4	5.8-8.5	Miller 42A336CBI or 16 turns No. 22 enam. wire close-wound on Miller form 42A000CBI.
20	0.6-1.1	11.5-16.6	8 turns No. 18 enam. wire close-wound on Miller form 42A000CBI.
15	0.3-0.48	18.5-23.5	4 1/2 turns No. 18 enam. wire close-wound on Miller form 42A000CBI.
10	0.18-0.28	25.8-32.0	3 turns No. 16 or 18 enam. or tinned bus wire spaced over 1/4-inch winding length on Miller form 42A000CBI.

which is essentially nonreactive can be made by mounting a 51- or a 56-ohm 1-W composition (carbon) resistor inside a PL-259 plug.

The body of the resistor should be inserted as far as possible into the plug, with one resistor lead extending through the center-conductor pin. Solder this center-pin connection, and clip off any excess lead length. Make a 1/2-in.-dia copper or brass disk with a small hole at its center. Use a 1/16-in. or, preferably, a No. 60 drill to make this hole. (Initially the "disk" may be a square or rough-cut piece of metal. It may be rounded by filing or grinding after the assembly process is completed.) Place the shell of the plug over its body, and then slip the disk over the grounded-end lead of the resistor, so the resistor lead protrudes through the small hole. First solder the disk to the body of the plug and then clip off any excess lead length from the resistor. Next, solder the connection at the small hole. The disk, when assembled in this manner, completes the shielding, reduces lead inductance, and also prevents the shell of the plug from being removed completely.

### Calibration

The resistance dial of the bridge may be calibrated by using a number of 1/2- or 1-watt 5-percent-tolerance composition resistors of different values in the 5- to 400-ohm range as loads. For this calibration, the appropriate frequency coil must be inserted at J2 and its inductance adjusted for the best null reading on the meter when *C2 is set with its plates half meshed*. For each test resistor, C1 is then adjusted for a null reading. Alternate adjustment of L1 and C1 should be made for a complete null. The leads between the test resistor and J3 should be as short as possible, and the calibration preferably should be done in the 3.5-MHz band where stray inductance and capacitance will have the least effect.

If the constructional layout of the bridge closely follows that shown in the photographs, the calibration scale of Fig. 17-20 may be used for the reactance dial. This calibration was obtained by connecting various reactances, measured on a laboratory bridge, in series with a 47-ohm 1-W resistor connected at J3. The scale is applied so that maximum capacitive reactance is indicated with C2 fully meshed.

If it is desired to obtain an individual calibration for C2, known values of inductance and capacitance may be used in series with a fixed resistor of the same approximate value as R1. For this calibration it is *very important* to keep the leads to the test components as short as possible, and calibration should be performed in the 3.5-MHz range to minimize the effects of stray reactances. Begin the calibration by setting C2 at half mesh, marking this point as 0 ohms reactance. With a purely resistive load connected at J3, adjust L1 and C1 for the best null on M1. From this point on during calibration, do not adjust L1 except to rebalance the bridge for a new calibration frequency. The ohmic value of the known reactance for the frequency of calibration is multiplied by

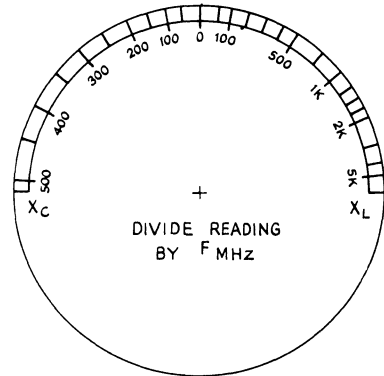

Fig. 17-20 — Calibration scale for the reactance dial used at C2 of the Macromatcher. See text.

the frequency in MHz to obtain the calibration value for the dial.

### Using the Impedance Bridge

This instrument is a low-input-power device, and is *not* of the type to be excited from a transmitter or left in the antenna line during station operation. Sufficient sensitivity for all measurements results when a 5-V rms rf signal is applied at J1. This amount of voltage can be delivered by most grid-dip oscillators. In no case should the power applied to J1 exceed 1 watt or damage to the instrument may result. The input impedance of the bridge at J1 is low, in the order of 50 to 100 ohms, so it is convenient to excite the bridge through a length of 52- or 75-ohm line such as RG-58/U or RG-59/U. If a grid-dip oscillator is used, a link coupling arrangement to the oscillator coil may be used. Fig. 17-16 shows two pickup link assemblies. The larger coil, 10 turns of 1-1/4-inch-dia stock with turns spaced at 8 turns per inch (B&W 3018), is used for the 160-, 80-, 40- and 20-meter bands. The smaller coil, 5 turns of 1-inch-dia stock with turns spaced at 4 turns per inch (B&W 3013), is used for the 15- and 10-meter bands. Coupling to the oscillator should be as light as possible, while obtaining sufficient sensitivity, to prevent severe "pulling" of the oscillator frequency. Overcoupling may cause the oscillator to shift in frequency by a few hundred kilohertz, so for the most reliable measurements, a receiver should be used to check the oscillator frequency.

Before measurements are made, it is necessary to balance the bridge. Set the reactance dial at zero and adjust L1 and C1 for a null with a nonreactive load connected at J3. This null should be complete; if not, reduce the signal level being applied to the Macromatcher. The instrument must be rebalanced after any appreciable change is made in the measurement frequency, more than approximately 1 percent. After the bridge is balanced, connect the unknown load to J3 and alternately adjust C1 and C2 for the best null. Measured impedances are of equivalent series form,  $R + jX/f$ ,

where  $R$  and  $X$  are the Macromatcher dial readings, and  $f$  is the frequency in megahertz. When the reactive component,  $X$ , is divided by the frequency, the result is  $R + jX$  in ohms.

As shown in Fig. 17-20, the calibration of the reactance dial is nonlinear, with a maximum indication for capacitive reactance of  $500/f$ . The measurement range for capacitive loads may be extended by "zeroing" the reactance dial at some value other than 0. For example, if the bridge is initially balanced with the reactance dial set at 500 in the  $X_L$  range, the 0 dial indication is now equivalent to an  $X_C$  reading of  $500/f$ , and the total range of measurement for  $X_C$  has been extended to  $1000/f$ .

When the Macromatcher is used at the antenna, excitation may be "piped" to the instrument through the coaxial line which normally feeds the antenna. Unless an assistant can check the oscillator frequency during each measurement, however, a grid-dip oscillator is unsatisfactory for this type of work. A more stable frequency source, such as a signal generator or QRP transmitter capable of delivering approximately 100 to 200 milliwatts, is ideal, as it can be left running during the time measurements and adjustments are being made. (Alternatively, the "power absorber" circuit of Fig. 17-6 may be used with higher power transmitters.) Here is where the Macromatcher can really be of value for adjustment of matching networks such as the  $L$ , gamma, and hairpin, because the resistive and reactive components of the load are indicated separately. In these networks

one adjustable element affects primarily the resistive component (the rod length of the gamma or the physical length of the hairpin), while the other adjustment affects primarily the reactive component (gamma-capacitor setting or driven-element length with the hairpin match). Of course there is some amount of interaction in the two adjustments, but the effects of making just one adjustment can be seen immediately on the Macromatcher. Obtaining an acceptable match in a matter of a few minutes is simple – adjust one of the two variables for the proper resistance, adjust the other variable for zero reactance, perform a slight touchup on these adjustments, and the job is finished.

Of course it is not necessary to use the Macromatcher at the load to determine the impedance. Measurements may be performed through an electrical half wavelength of feed line. Disregarding attenuation (which will be negligible if the line is only a single half wave in length) the impedance will be the same at the input end of the line as it is at the load, no matter what the line impedance may be. Nor is it necessary to trim the coaxial line to an exact half wavelength (good for a single frequency only) in order to make "remote" measurements accurately. The line may be of any convenient physical length, but its electrical length must be known. Readings taken at the input end of the line can be converted into actual impedances at the termination point of the line by means of a Smith Chart, as described in Chapter Three. Line attenuation may also be taken into account.

## ANTENNA MEASUREMENTS

Of all the measurements made in amateur radio communications systems, perhaps the most difficult and least understood is the measurement of antennas. For example, it is relatively easy to measure the frequency and cw power output of a transmitter, the response of a filter, or the gain of an amplifier. These are all what might be called bench measurements because, when performed properly, all the factors which influence the accuracy and success of the measurement are under control. In making antenna measurements however, the "bench" is now perhaps the backyard. In other words, the environment surrounding the antenna can affect the results of the measurement. Control of the environment is not at all as simple as it was for the bench measurement, because now the work area may be rather spacious. This section describes antenna measurement techniques which are closely allied to those used in an antenna measuring event or contest. With these procedures the measurements can be made successfully and with meaningful results. These techniques should provide a better understanding of the measurement problems, resulting in a more accurate and less difficult task. (Information provided by Dick Turrin, W2IMU.)

### SOME BASIC IDEAS

An antenna is simply a transducer or coupler

between a suitable feed line and the environment surrounding it. In addition to efficient transfer of power from feed line to environment, an antenna at vhf or uhf is most frequently required to concentrate the radiated power into a particular region of the environment.

In order to be consistent in comparing different antennas, it is necessary that the environment surrounding the antenna be standardized. Ideally, measurements should be made with the measured antenna so far removed from any objects causing environmental effects that it is literally in outer space – a very impractical situation. The purpose of the measurement techniques is therefore to simulate, under practical conditions, a controlled environment. At vhf and uhf, and with practical-size antennas, the environment *can* be controlled so that successful and accurate measurements can be made in a reasonable amount of space.

The electrical characteristics of an antenna which are most desirable to obtain by direct measurement are: (1) gain (relative to an isotropic source, which by definition has a gain of unity); (2) space-radiation pattern; (3) feed-point impedance (mismatch) and (4) polarization.

### Polarization

In general the polarization can be assumed from the geometry of the radiating elements. That is to say, if the antenna is made up of a number of

linear elements (straight lengths of rod or wire which are resonant and connected to the feed point) the polarization of the electric field will be linear and polarized parallel to the elements. If the elements are not consistently parallel with each other, then the polarization cannot easily be assumed. The following techniques are directed to antennas having polarization that is essentially linear (in one plane), although the method can be extended to include all forms of elliptic polarization.

### Feed-Point Mismatch

The feed-point mismatch, although affected to some degree by the immediate environment of the antenna, does *not* affect the gain or radiation characteristics of an antenna. If the immediate environment of the antenna does not affect the feed-point impedance, then any mismatch intrinsic to the antenna tuning reflects a portion of the incident power back to the source. In a receiving antenna this reflected power is reradiated back into the environment, "free space," and can be lost entirely. In a transmitting antenna, the reflected power goes back to the final amplifier of the transmitter. In general an amplifier is *not* a matched source to the feed line, and, if the feed line has very low loss, the amplifier output controls are customarily altered during the normal tuning procedure to obtain maximum power transfer to the antenna. The power which has been reflected from the antenna combines with the source power to travel again to the antenna. This procedure is called conjugate matching, and the feed line is now part of a resonant system consisting of the mismatched antenna, feed line, and amplifier tuning circuits. It is therefore possible to use a mismatched antenna to its full gain potential, provided the mismatch is not so severe as to cause heating losses in the system, especially the feed line and matching devices. Similarly, a mismatched receiving antenna may be conjugately matched into the receiver front end for maximum power transfer. In any case it should be clearly kept in mind that the feed-point mismatch does *not* affect the radiation characteristics of an antenna. It can only affect the system efficiency wherein heating losses are concerned.

Why then do we include feed-point mismatch as part of the antenna characteristics? The reason is that for efficient system performance most antennas are resonant transducers and present a reasonable match over a relatively narrow frequency range. It is therefore desirable to design an antenna, whether it be a simple dipole or an array of Yagis, such that the final single feed-point impedance be essentially resistive and of magnitude consistent with the impedance of the feed line which is to be used. Furthermore, in order to make accurate, absolute gain measurements, it is vital that the antenna under test accept all the power from a matched-source generator, or that the reflected power caused by the mismatch be measured and a suitable error correction for heating losses be included in the gain calculations. Heating

losses may be determined from information contained in Chapter Three.

While on the subject of feed-point impedance, mention should be made of the use of baluns in antennas. A balun is simply a device which permits a lossless transition between a balanced system — feed line or antenna — and an unbalanced feed line or system. If the feed point of an antenna is symmetric such as with a dipole and it is desired to feed this antenna with an unbalanced feed line such as coax, it is necessary to provide a balun between the line and the feed point. Without the balun, current will be allowed to flow on the outside of the coax. The current on the outside of the feed line will cause radiation and thus the feed line becomes part of the antenna radiation system. In the case of beam antennas where it is desired to concentrate the radiated energy in a specific direction, this extra radiation from the feed line will be detrimental, causing distortion of the expected antenna pattern.

## ANTENNA TEST SITE SET-UP AND EVALUATION

Since an antenna is a reciprocal device, measurements of gain and radiation patterns can be made with the test antenna used either as a transmitting or as a receiving antenna. In general and for practical reasons, the test antenna is used in the receiving mode, and the source or transmitting antenna is located at a specified fixed remote site and unattended. In other words the source antenna, energized by a suitable transmitter, is simply required to illuminate or flood the receiving site in a controlled and constant manner.

As mentioned earlier, antenna measurements ideally should be made under "free-space" conditions. A further restriction is that the illumination from the source antenna be a plane wave over the effective aperture (capture area) of the test antenna. A plane wave by definition is one in which the magnitude and phase of the fields are uniform, and in the test-antenna situation, *uniform over the effective area plane of the test antenna*. Since it is the nature of all radiation to expand in a spherical manner at great distance from the source, it would seem to be most desirable to locate the source antenna as far from the test site as possible. However, since for practical reasons the test site and source location will have to be near the earth and not in outer space, the environment must include the effects of the ground surface and other obstacles in the vicinity of both antennas. These effects almost always dictate that the test range (spacing between source and test antennas) be as short as possible consistent with maintaining a nearly error-free plane wave illuminating the test aperture.

A nearly error-free plane wave can be specified as one in which the phase and amplitude, from center to edge of the illuminating field over the test aperture, do not deviate by more than about 30 degrees and 1 decibel, respectively. These conditions will result in a gain-measurement error of no more than a few percent less than the true gain.

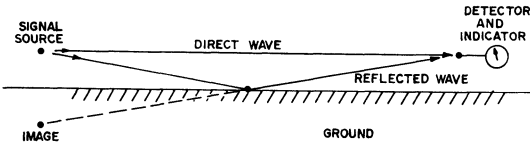

Fig. 17-21 — On an antenna test range, energy reaching the receiving equipment may arrive after being reflected from the surface of the ground, as well as by the direct path. The two waves may tend to cancel each other, or may reinforce one another, depending on their phase relationship at the receiving point.

Based on the 30-degree phase error alone, it can be shown that the minimum range distance is approximately

$$S_{\min} = 2 \frac{D^2}{\lambda}$$

where  $D$  is the largest aperture dimension and  $\lambda$  is the free-space wavelength in the same units as  $D$ . The phase error over the aperture  $D$  for this condition is  $1/16$  wavelength.

Since aperture size and gain are related by

$$\text{Gain} = \frac{4\pi A_e}{\lambda^2}$$

where  $A_e$  is the effective aperture area, the dimension  $D$  may be obtained for simple aperture configurations. For a square aperture

$$D^2 = G \frac{\lambda^2}{4\pi}$$

which results in a minimum range distance for a square aperture of

$$S_{\min} = G \frac{\lambda}{2\pi}$$

and for a circular aperture of

$$S_{\min} = G \frac{2\lambda}{\pi^2}$$

For apertures with a physical area that is not well defined or is much larger in one dimension than in other directions, such as a long thin array for maximum directivity in one plane, it is advisable to use the maximum estimate of  $D$  from either the expected gain or physical aperture dimensions.

Up to this point in the range development, only the conditions for minimum range length,  $S_{\min}$ , have been established, as though the ground surface were not present. This minimum  $S$  is therefore a necessary condition even under "free-space" environment. The presence of the ground further complicates the range selection, not in the determination of  $S$  but in the exact location of the source and test antennas above the earth.

It is always advisable to select a range whose intervening terrain is essentially flat, clear of obstructions, and of uniform surface conditions, such as all grass or all pavement. The extent of the range is determined by the illumination of the source antenna, usually a beam, whose gain is no

greater than the highest gain antenna to be measured. For gain measurements the range consists essentially of the region in the beam of the test antenna. For radiation-pattern measurements, the range is considerably larger and consists of all that area illuminated by the source antenna, especially around and behind the test site. Ideally a site should be chosen where the test-antenna location is near the center of a large open area and the source antenna located near the edge where most of the obstacles (trees, poles, fences, etc.) lie.

The primary effect of the range surface is that some of the energy from the source antenna will be reflected into the test antenna, while other energy will arrive on a direct line-of-sight path. This is illustrated in Fig. 17-21. The use of a flat, uniform ground surface assures that there will be essentially a mirror reflection even though the reflected energy may be slightly weakened (absorbed) by the surface material (ground). In order to perform an analysis it is necessary to realize that horizontally polarized waves undergo a 180-degree phase reversal upon reflection from the earth. The resulting illumination amplitude at any point in the test aperture is the vector sum of the electric fields arriving from the two directions, the direct path and the reflected path. If a perfect mirror reflection is assumed from the ground (it is nearly that for practical ground conditions at vhf/uhf) and the source antenna is isotropic, radiating equally in all directions, then a simple geometric analysis of the two path lengths will show that at various points in the vertical plane at the test-antenna site the waves will combine in different phase relationships. At some points the arriving waves will be in phase, and at other points they will be 180 degrees out of phase. Since the field amplitudes are nearly equal, the resulting phase change due to path length difference will produce an amplitude variation in the vertical test site direction similar to a standing wave, as shown in Fig. 17-22.

The simplified formula relating the location of  $h_2$  for maximum and minimum values of the two-path summation in terms of  $h_1$  and  $S$  is

$$h_2 = n \frac{\lambda}{4} \cdot \frac{S}{h_1}$$

with  $n = 0, 2, 4 \dots$  for minimums and

$n = 1, 3, 5 \dots$  for maximums, and  $S$  is much larger than either  $h_1$  or  $h_2$ .

The significance of this simple ground reflection formula is that it permits the approximate location of the source antenna to be determined to achieve a nearly plane-wave amplitude distribution in the vertical direction over a particular test aperture size. It should be clear from examination of the height formula that as  $h_1$  is decreased, the vertical distribution pattern of signal at the test site,  $h_2$ , expands. Also note that the signal level for  $h_2$  equal to zero is always zero on the ground regardless of the height of  $h_1$ .

The objective in using the height formula then is, given an effective antenna aperture to be illuminated from which a minimum  $S$  (range

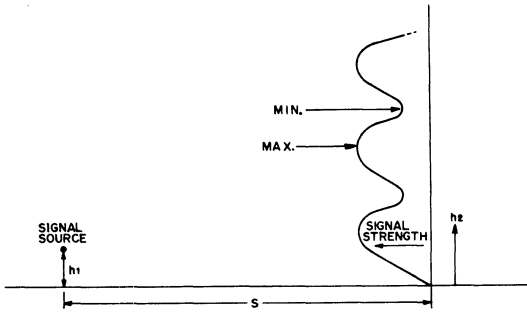

Fig. 17-22 — The vertical profile, or plot of signal strength versus test-antenna height, for a fixed height of the signal source above ground and at a fixed distance. See text for definitions of symbols.

length) is determined and a suitable range site chosen, to find a value for  $h_1$  (source antenna height). The required value is such that the *first* maximum of vertical distribution at the test site,  $h_2$ , is at a practical distance above the ground and at the same time the signal amplitude over the aperture in the vertical direction does not vary more than about 1 dB. This last condition is not sacred but is closely related to the particular antenna under test. In practice these formulas are only useful to initialize the range setup. A final check of the vertical distribution at the test site must be made by direct measurement. This measurement should be conducted with a small low-gain but unidirectional probe antenna such as a corner reflector or 2 element Yagi which is moved along a vertical line over the intended aperture site. Care should be exercised to minimize the effects of local environment around the probe antenna and that the beam of the probe be directed at the source antenna at all times for maximum signal. A simple dipole is undesirable as a probe antenna because it is susceptible to local environmental effects.

The most practical way to instrument the vertical distribution measurement is to construct some kind of vertical track, preferably of wood, with a sliding carriage or platform which may be used to support and move the probe antenna. It is assumed of course that a stable source transmitter and calibrated receiver or detector are available so that variations of the order of 1/2 dB can be clearly distinguished.

Once these initial range measurements are completed successfully, the range is now ready to accommodate any aperture size less in vertical extent than the largest for which  $S_{min}$  and the vertical field distribution were selected. The test antenna is placed with the center of its aperture at the height  $h_2$  where maximum signal was found. The test antenna should be tilted so that its main beam is pointed in the direction of the source antenna. The final tilt is found by observing the receiver output for maximum signal. This last process must be done empirically since the apparent location of the source is somewhere between the actual source and its image, below the ground.

An example will illustrate the procedure. Assume that we wish to measure a 7-foot-diameter parabolic reflector antenna at 1296 MHz ( $\lambda = 0.75$  foot). The minimum range distance,  $S_{min}$ , can be readily computed from the formula for a circular aperture.

$$S_{min} = 2 \frac{D^2}{\lambda} = 2 \times \frac{49}{0.75} = 130 \text{ feet}$$

Now a suitable site is selected based on the qualitative discussion given before.

Next determine the source height,  $h_1$ . The procedure is to choose a height  $h_1$  such that the first minimum above ground ( $n = 2$  in formula) is at least two or three times the aperture size, or about 20 feet.

$$h_1 = n \frac{\lambda}{4} \frac{S}{h_2} = 2 \times \frac{0.75}{4} \times \frac{130}{20} = 2.4 \text{ feet}$$

Place the source antenna at this height and probe the vertical distribution over the seven-foot aperture location, which will be about ten feet off the ground.

$$h_2 = n \frac{\lambda}{4} \frac{S}{h_1} = 1 \times \frac{0.75}{4} \times \frac{130}{2.4} = 10.2 \text{ feet}$$

The measured profile of vertical signal level versus height should be plotted. From this plot, empirically determine whether the seven-foot aperture can be fitted in this profile such that the 1-dB variation is not exceeded. If the variation exceeds 1 dB over the seven-foot aperture, the source antenna should be lowered and  $h_2$  raised. Small changes in  $h_1$  can quickly alter the distribution at the test site. Fig. 17-23 illustrates the points of the previous discussion.

The same set-up procedure applies for either horizontal or vertical linear polarization. However, it is advisable to check by direct measurement at the site for each polarization to be sure that the vertical distribution is satisfactory. Distribution probing in the horizontal plane is unnecessary as little or no variation in amplitude should be found, since the reflection geometry is constant. Because

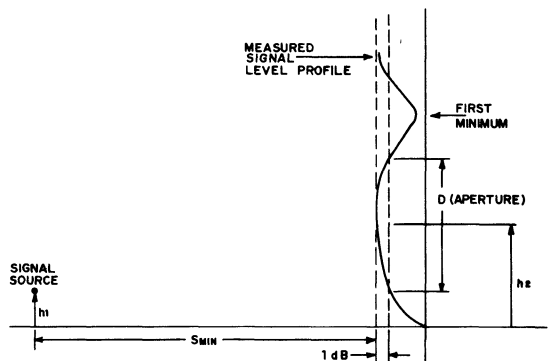

Fig. 17-23 — Sample plot of a measured vertical profile.

of this, antennas with apertures which are long and thin, such as a stacked collinear vertical, should be measured with the long dimension parallel to the ground.

A particularly difficult range problem occurs in measurements of antennas which have depth as well as cross-sectional aperture area. Long end-fire antennas such as long Yagis, rhombics, V-beams, or arrays of these antennas, radiate as volumetric arrays and it is therefore even more essential that the illuminating field from the source antenna be reasonably uniform in depth as well as plane wave in cross section. For measuring these types of antennas it is advisable to make several vertical profile measurements which cover the depth of the array. A qualitative check on the integrity of the illumination for long end-fire antennas can be made by moving the array or antenna axially (forward and backward) and noting the change in received signal level. If the signal level varies less than 1 or 2 dB for an axial movement of several wavelengths then the field can be considered satisfactory for most demands on accuracy. Large variations indicate that the illuminating field is badly distorted over the array depth and subsequent measurements are questionable. It is interesting to note in connection with gain measurements that any illuminating field distortion will always result in measurements which are lower than true values.

## ABSOLUTE GAIN MEASUREMENT

Having established a suitable range, the measurement of gain relative to an isotropic (point source) radiator is almost always accomplished by direct comparison with a calibrated standard-gain antenna. That is, the signal level with the test

antenna in its optimum location is noted. Then the test antenna is removed and the standard-gain antenna is placed with its aperture at the center of location where the test antenna was located. The difference in signal level between the standard and the test antennas is measured and appropriately added to or subtracted from the gain of the standard-gain antenna to obtain the absolute gain of the test antenna, absolute here meaning with respect to a point source which has a gain of unity by definition. The reason for using this reference rather than a dipole, for instance, is that it is more useful and convenient for system engineering. It is assumed that both standard and test antennas have been carefully matched to the appropriate impedance and an accurately calibrated and matched detecting device is being used.

A standard-gain antenna may be any type of unidirectional, preferably planar-aperture, antenna, which has been calibrated either by direct measurement or in special cases by accurate construction according to computed dimensions.

A standard-gain antenna has been suggested by the National Bureau of Standards. It consists of two in-phase dipoles one half wavelength apart and backed up with a ground plane one wavelength square. Such an antenna is shown in Fig. 17-24. When constructed accurately to scale for the frequency of interest, this type of standard will have an absolute gain of 7.7 dB with an accuracy of plus or minus .25 dB.

## RADIATION-PATTERN MEASUREMENTS

Of all antenna measurements, the radiation pattern is the most demanding in measurement and most difficult to interpret. Any antenna radiates to some degree in all directions into the space surrounding it. Therefore, the radiation pattern of an antenna is a three-dimensional representation of the magnitude, phase and polarization. In general, and in practical cases for amateur radio communications, the polarization is well defined and only the magnitude of radiation is important. Furthermore, in many of these cases the radiation in one particular plane is of primary interest, usually the plane corresponding to that of the earth's surface, regardless of polarization.

Because of the nature of the range set-up, measurement of radiation pattern can only be successfully made in a plane nearly parallel to the earth's surface. With beam antennas it is advisable and usually sufficient to take two radiation pattern measurements, one in the polarization plane and one at right angles to the plane of polarization. These radiation patterns are referred to in antenna literature as the principal *E*-plane and *H*-plane patterns, respectively, *E* plane meaning parallel to the electric field which is the polarization plane and *H* plane meaning parallel to the magnetic field. The electric field and magnetic field are always perpendicular to each other in a plane wave as it propagates through space.

The technique in obtaining these patterns is simple in procedure but requires more equipment

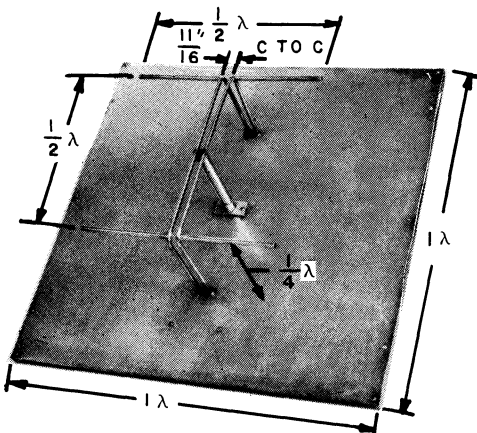

Fig. 17-24 — Standard-gain antenna suggested by National Bureau of Standards. When accurately constructed for the desired frequency, this antenna will exhibit a gain of 7.7 dB over a half-wave dipole radiator, plus or minus 0.25 dB. In this model, constructed for 432 MHz, the elements are 3/8-inch dia tubing. The phasing and support lines are of 5/16-inch dia tubing or rod.



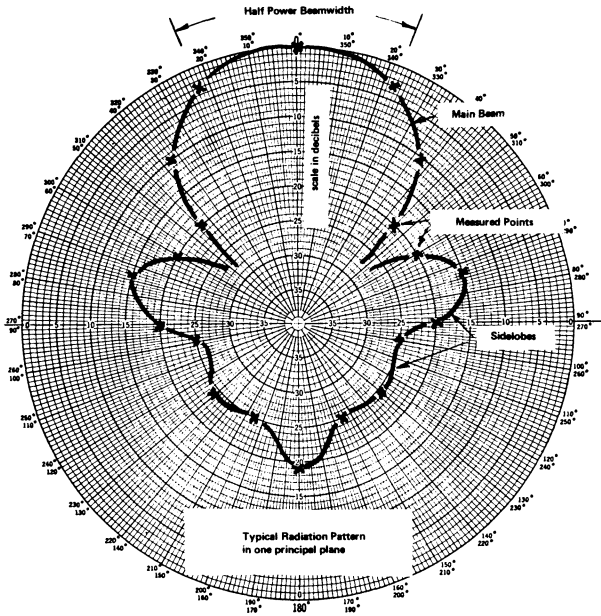

Fig. 17-25 – Sample plot of a measured radiation pattern, using techniques described in the text.

or patience than does making a gain measurement. First, a suitable mount is required which can be rotated in the azimuth plane (horizontal) with some degree of accuracy in terms of azimuth angle positioning. Second, a signal-level indicator calibrated over at least a 20-dB dynamic range with a readout resolution of at least 2 dB is required. A dynamic range of up to about 40 dB would be desirable but does not add greatly to the measurement significance.

With this much equipment, the procedure is to locate first the area of maximum radiation from the beam antenna by carefully adjusting the azimuth and elevation positioning. These settings are then arbitrarily assigned an azimuth angle of zero degrees and a signal level of zero decibels. Next, without changing the elevation setting (tilt of the rotating axis), the antenna is carefully rotated in azimuth in small steps which permit signal-level readout of 2 or 3 dB per step. These points of signal level corresponding with an azimuth angle are recorded and plotted on polar coordinate paper. A sample of the results is shown on polar coordinate paper in Fig. 17-25.

On the sample radiation pattern the measured points are marked with an X and a continuous line is drawn in, since the pattern is a continuous curve. Radiation patterns should preferably be plotted on a logarithmic radial scale, rather than a voltage or power scale. The reason is that the log scale approximates the response of the ear to signals in the audio range. Also many receivers have agc systems that are somewhat logarithmic in response; therefore the log scale is more representative of actual system operation.

Having completed a set of radiation-pattern measurements, one is prompted to ask, "Of what

use are they?" The primary answer is as a diagnostic tool to determine if the antenna is functioning as it was intended to. A second answer is to know how the antenna will discriminate against interfering signals from various directions.

Consider now the diagnostic use of the radiation patterns. If the radiation beam is well defined, then there is an approximate formula relating the antenna gain to the measured half-power beamwidth of the *E*- and *H*-plane radiation patterns. The half-power beamwidth is indicated on the polar plot where the radiation level falls to 3 dB below the main beam 0-dB reference on either side. The formula is

$$\text{Gain} \approx \frac{40,000}{\theta_E \times \phi_H}$$

where  $\theta_E$  and  $\phi_H$  are the half-power beamwidths in degrees of the *E*- and *H*-plane patterns respectively.

To illustrate the use of this formula, assume that we have a Yagi antenna with a boom length of two wavelengths. From known relations (described in Chapter Four) the expected gain of a Yagi with a boom length of two wavelengths is about 13 dB; its gain, *G*, equals 20. Using the formula, the product of  $\theta_E \times \phi_H = 2000$  square degrees. Since a Yagi produces a nearly symmetric beam shape in cross section,  $\theta_E \approx \phi_H = 45$  degrees. Now if the measured values of  $\theta_E$  and  $\phi_H$  are much larger than 45 degrees, then the gain will be much lower than the expected 13 dB.

As another example, suppose that the same antenna (a 2-wavelength-boom Yagi) gives a measured gain of 9 dB but the radiation pattern half power beamwidths are approximately 45 degrees. This situation indicates that although the radiation patterns seem to be correct, the low gain shows

inefficiency somewhere in the antenna, such as lossy materials or poor connections.

Large broadside collinear antennas can be checked for excessive phasing-line losses by comparing the gain computed from the radiation patterns with the direct-measured gain. It seems paradoxical but it is indeed possible to build a large array with a very narrow beamwidth indicating high gain but actually having very low gain because of losses in the feed distribution system.

In general, and for most vhf/uhf amateur radio communications, gain is the primary attribute of an antenna. However, radiation in other directions than the main beam, called side-lobe radiation, should be examined by measurement of radiation patterns for effects such as non symmetry on either side of the main beam or excessive magnitude of sidelobes (any sidelobe which is less than 10 dB below the main beam reference level of 0 dB should be considered excessive). These effects are usually attributable to incorrect phasing of the radiating elements or radiation from other parts of the antenna which was not intended, such as the support structure or feed line.

The interpretation of radiation patterns is intimately related to the particular type of antenna under measurement. Reference data should be consulted for the particular antenna type of interest, to verify that the measured results are in agreement with expected results.

To summarize the use of pattern measurements, if a beam antenna is first checked for gain (the easier measurement to make) and it is as expected,

then pattern measurements may be academic. However, if the gain is lower than expected it is advisable to make the pattern measurements as an aid in determining the possible cause of low gain.

Regarding radiation-pattern measurements, it should be remembered that the results measured under proper range facilities will not necessarily be the same as observed for the same antenna at a home-station installation. The reasons may be obvious now in view of the preceding information on the range set-up, ground reflections, and the vertical-field distribution profiles. For long paths over rough terrain where many large obstacles may exist, these effects of ground reflection tend to become diffused, although they still can cause unexpected results. For these reasons it is usually unjust to compare vhf/uhf antennas over long paths.

### Bibliography

Source material and more extended discussion of topics covered in this chapter can be found in the references given below.

- Bruene, "An Inside Picture of Directional Wattmeters," *QST*, April, 1959.  
 DeMaw, "In-Line RF Power Metering," *QST*, December, 1969.  
 Hall and Kaufmann, "The Macromatcher, an RF Impedance Bridge for Coax Lines," *QST*, January, 1972.  
 McMullen, "The Line Sampler, an RF Power Monitor for VHF and UHF," *QST*, April, 1972.

# Finding Directions

Anyone laying out a fixed directive array does so in order to put his signal into certain parts of the world; in such cases, it is essential to be able to determine the bearings of the desired points. Too, the amateur with the rotatable directive array likes to know where to aim if he is trying to pick up certain countries. And even the amateur with the single wire is interested in the directive pattern of the lobes when the wire is operated harmonically at the higher frequencies, and often is able to vary the direction of the wire to take advantage of the lobe pattern.

## FINDING DIRECTION

It is probably no news to most people nowadays that true direction from one place to another is not what it appears to be on the old Mercator school map. On such a map, if one starts "east" from central Kansas, he winds up in the neighborhood of Lisbon, Portugal. Actually, as a minute's experiment with a strip of paper on a small globe will show, a signal starting due east from Kansas never hits Europe at all but goes into the southern part of Portuguese West Africa.

If, therefore, we want to determine the direction of some distant point from our own location, the ordinary Mercator projection is utterly useless.

True bearing, however, may be found in several ways: by using a special type of world map that *does* show true direction from a specific location to other parts of the world; by working directly from a globe; or by using mathematics.

## DETERMINING TRUE NORTH

Determining the direction of distant points is of little use to the amateur erecting a directive array unless he can put up the array itself in the desired direction. This, in turn, demands a knowledge of the direction of *true* north (as against magnetic north), since all our directions from a globe or map are worked in terms of true north.

A number of ways may be available to the amateur for determining true north from his location. Frequently, the streets of a city or town are laid out, quite accurately, in north-south and east-west directions. A visit to the office of your city engineer will enable you to determine whether

or not this is the case for the street in front of or paralleling your own lot. Or from such a visit it is often possible to locate some landmark, such as a factory chimney or church spire, which lies true north with respect to your house.

If you cannot get true north by such means, three other methods are available: compass, pole star and sun.

### By Compass

Get as large a compass as you can; it is difficult, though not impossible, to get satisfactory results with the "pocket" type. In any event, the compass *must* have not more than two degrees per division.

It must be remembered that the compass points to *magnetic* north, not true north. The amount by which magnetic north differs from true north in a particular location is known as *variation*. Your local weather bureau or city engineer's office can tell you the magnetic variation for your locality. The information is also available from U.S. Geological Survey topographic maps for your locality, which may be on file in your local library. When correcting your "compass north," do so *opposite*

TABLE 18-1

Apply to Clock Time as Indicated by the Sign, To Get Time of True Noon

Jan. 1	+ 4 min.	July 10	+ 5 min.
10	+ 8 "	20	+ 6 "
20	+ 11 "	30	+ 6 "
30	+ 13 "		
Feb. 10	+ 14 "	Aug. 10	+ 5 "
20	+ 14 "	20	+ 3 "
28	+ 13 "	30	+ 1 "
Mar. 10	+ 10 "	Sept. 10	- 3 "
20	+ 8 "	20	- 7 "
30	+ 4 "	30	- 10 "
Apr. 10	+ 1 "	Oct. 10	- 13 "
20	- 1 "	20	- 15 "
30	- 3 "	30	- 16 "
May 10	- 4 "	Nov. 10	- 16 "
20	- 4 "	20	- 14 "
30	- 3 "	30	- 11 "
June 10	- 1 "	Dec. 10	- 7 "
20	+ 1 "	20	- 2 "
30	+ 4 "	30	+ 3 "

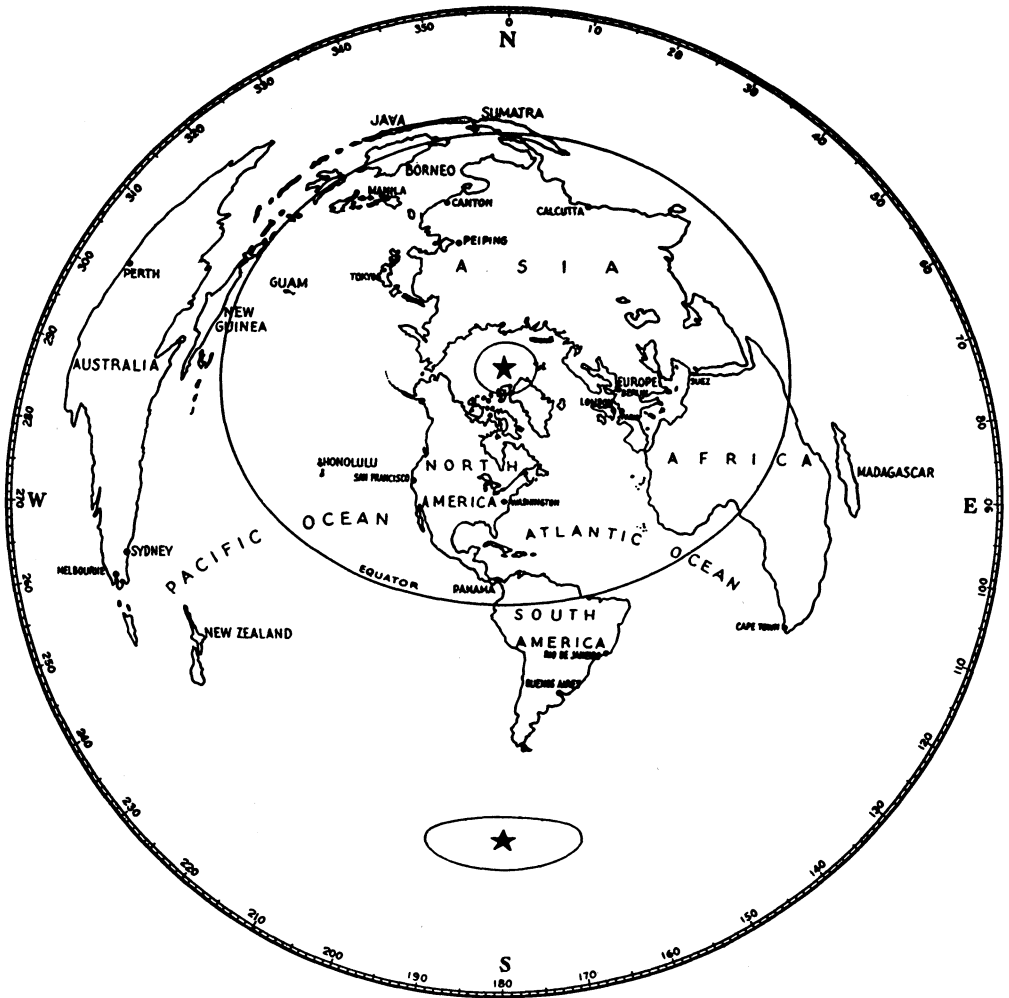

Fig. 18-1 — Azimuthal map centered on Washington, D.C.

to the direction of the variation. For instance, if the variation for your locality is 12 degrees west (meaning that the compass points 12 degrees west of north) then true north is found by counting 12 degrees *east* of north as shown on the compass.

When taking the bearing, make sure that the compass is located well away from ironwork, fencing, pipes, etc. Place the instrument on a wooden tripod or support of some sort, at a convenient height as near eye level as possible. Make yourself a sighting stick from a flat stick about two feet long with a nail driven upright in each end (for use as "sights") and then, after the needle of the compass has settled down, carefully lay this stick across the face of the compass — with the necessary allowance for variation — to line it up on true north. *Be sure you apply the variation correctly.*

This same sighting-stick and compass rig can also be used in laying out directions for supporting poles for antennas in other directions — provided,

of course, that the compass dial is graduated in degrees.

#### By the Pole Star

Many amateurs use the pole star, Polaris, in determining the direction of true north. An advantage is that the pole star is never more than  $0.8^\circ$  from true north, so that in practice no corrections are necessary. Disadvantages are that some people have difficulty identifying the pole star, and that because of its comparatively high angle above the horizon at high northerly latitudes, it is not always easy to "sight" on it accurately. Polaris is not visible in the southern hemisphere. In any event, if visible, it is a handy check on the direction secured by other means.

#### By the Sun

With some slight preparation, the sun can easily be used for determination of true north. One of

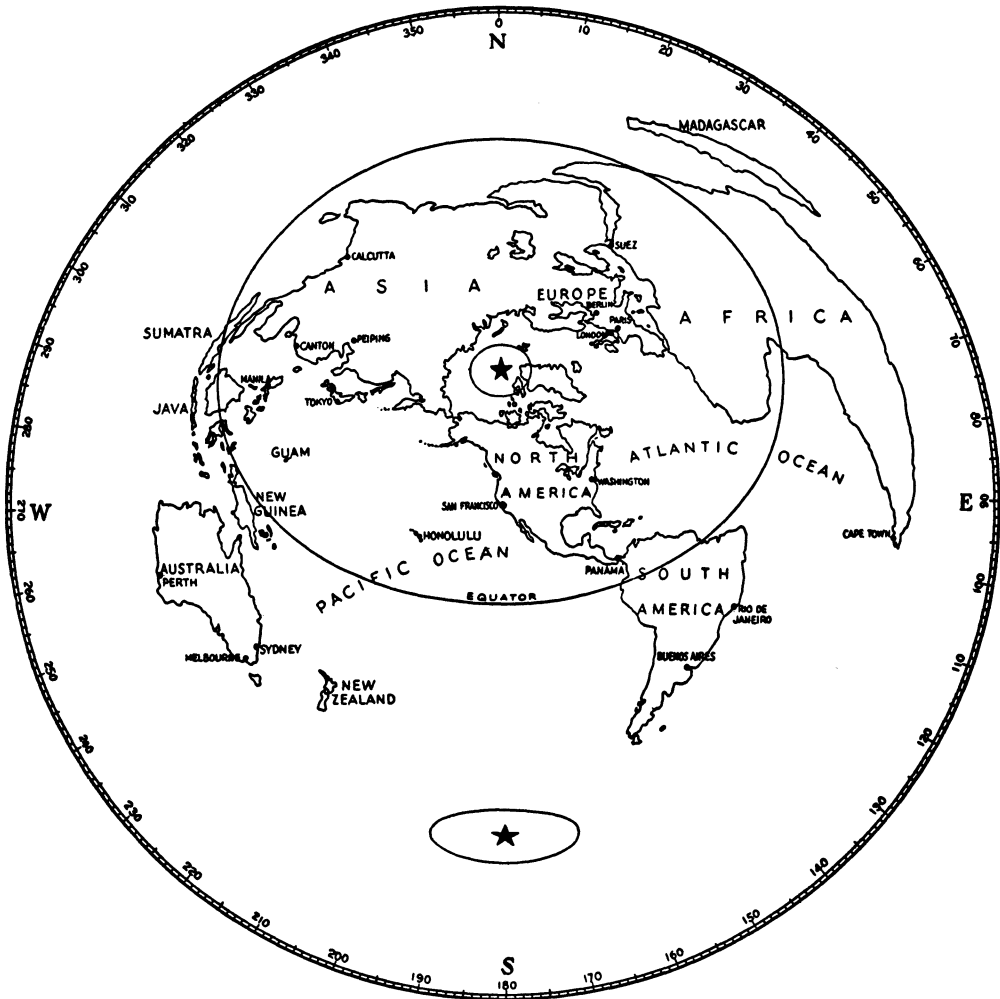

Fig. 18-2 — Azimuthal map centered on San Francisco, Calif.

the most satisfactory methods is described below. The method is based on the fact that exactly at noon, local time, the sun bears due south, so that at that time the shadow of a vertical stick or rod will bear north. The resulting shadow direction, incidentally, is true north.

Two corrections to your standard time must be made to determine the exact moment of local true noon.

The first is a longitude correction. Standard Time is time at some particular meridian of longitude: EST is based on the 75th meridian; CST on the 90th meridian; MST on the 105th meridian; and PST on the 120th meridian. From an atlas, determine the difference between your own longitude and the longitude of your time meridian. Getting this to the nearest 15 minutes of longitude is close enough. Example: Newington, Conn., which runs on 75th meridian time (EST) is at 72°45' longitude, or a difference of 2°15'. Now, for each 15' of longitude, figure 1 minute of time;

thus 2°15' is equivalent to 9 minutes of time (there are 60 "angle" minutes to a degree, so that each degree of longitude equals 4 minutes of time). Subtract this correction from noon if you are east of your time meridian; add it if you are west.

To the resulting time, apply a further correction for the date from Table 18-I. The resulting time is the time, by Standard Time, when it will be true noon at your location. Put up your vertical stick (use a plumb bob to make sure it is actually vertical), check your watch with Standard Time, and, at the time indicated from your calculations, mark the position of the shadow. That is true north.

In the case of Newington, if we wanted correct time for true noon on October 20: First, subtracting the longitude correction — because we are east of the time meridian — we get 11:51 A.M.; then, applying the further correction of -15 minutes, we get 11:36 A.M. EST (12:36 P.M. EDST) as the time of true noon at Newington on October 20.

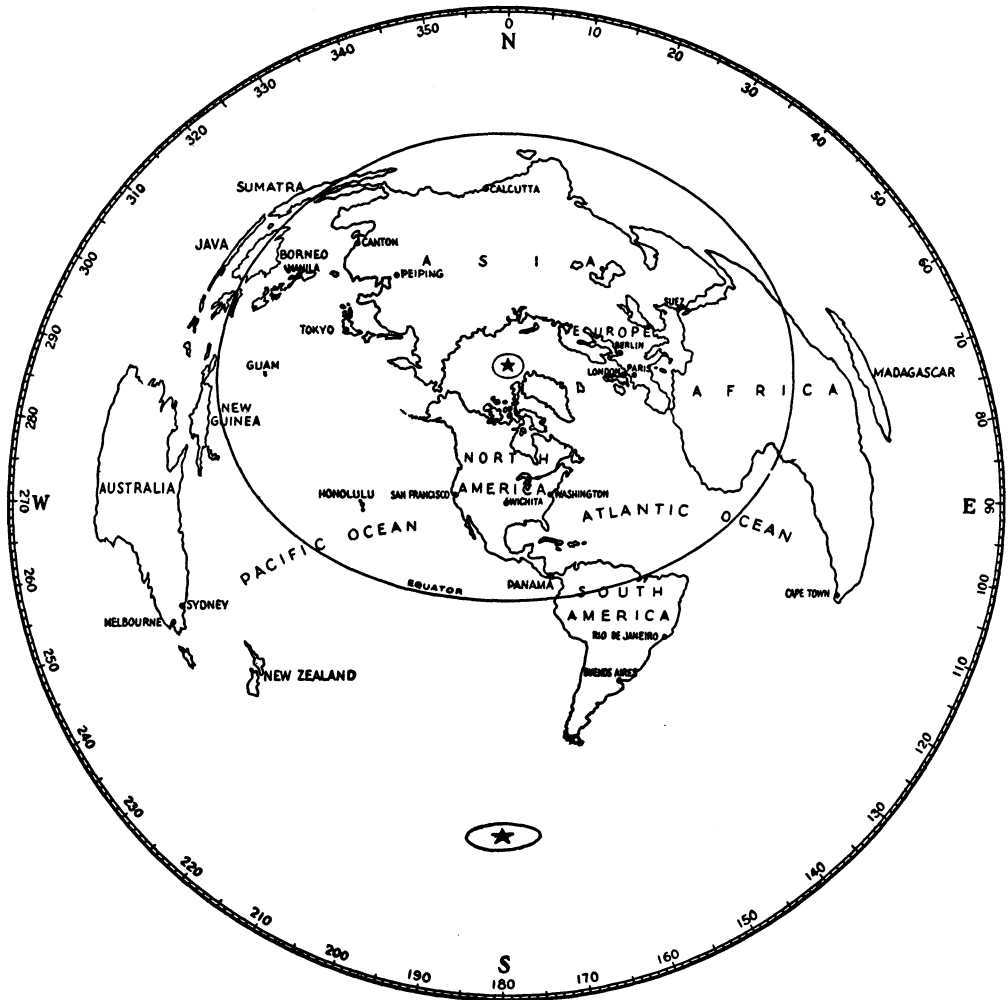

Fig. 18-3 — Azimuthal map centered on Wichita, Kansas.

Copyright by Rand McNally & Co., Chicago. Reproduction License No. 394.

## AZIMUTHAL MAPS

While the Mercator projection does not show true directions, it is possible to make up a map which will show true bearings for all parts of the world from any single point. Three such maps are reproduced in this chapter. Fig. 18-1 shows directions from Washington, D.C., Fig. 18-2 gives directions from San Francisco and Fig. 18-3 (a simplified version of the ARRL amateur radio map of the world) gives directions from the approximate center of the United States — Wichita, Kansas.

For anyone living in the immediate vicinity (within 150 miles) of any of these three reference points, the directions as taken from the maps will have a high degree of accuracy. However, one or the other of the three maps will suffice for any location in the United States for all except the

most accurate work; simply pick the map whose reference point is nearest you. Greatest errors will arise when your location is to one side or the other of a line between the reference point and the destination point; if your location is near or on the resulting line, there will be little or no error.

By tracing the directional pattern of the antenna system on a sheet of tissue paper, then placing the paper over the azimuthal map with the origin of the pattern at one's location, the "coverage" of the antenna will be readily evident. This is a particularly useful stunt when a multilobed antenna, such as any of the long single-wire systems, is to be laid out so that the main lobes cover as many desirable directions as possible. Often a set of such patterns will be of considerable assistance in determining what length antenna to put up, as well as the direction in which it should run.

The current edition of the ARRL Amateur Radio Map of the World, entirely different in concept and design from any other radio amateurs' map, contains a wealth of information especially useful to amateurs. A special type of azimuthal projection made by Rand-McNally to ARRL specifications, it gives great-circle bearings from the geographical center of the United States, as well as great-circle distance measurement in miles and kilometers, within an accuracy of two percent. The map shows principal cities of the world; local time zones; WAC divisions; more than 265 countries, indexed; and amateur prefixes throughout the world. The map is large enough to be easily readable from the operating position, 30 × 40 inches; and is printed in six colors on heavy paper. Cost is two dollars from ARRL Headquarters, 225 Main St., Newington, Conn. 06111.

The *Radio Amateur's Callbook* also includes great-circle maps and tables, and another *Callbook* publication, *The Radio Amateur's World Atlas* (price, \$2.50), features a polar-projection world map, maps of the continents, and world amateur prefixes. The maps are in color.

### WORKING FROM A GLOBE

Bearings for beam-heading purposes may be determined easily from an ordinary globe with nothing more complicated than a small school protractor of the type available in any school-supply or stationery store. For best results, however, the globe should be at least eight inches in diameter. A thin strip of paper may be used for a straightedge to determine the great-circle path between your location and any other location on the earth's surface. The bearing from your location may be determined with the aid of the protractor. For convenience, a paper-scale circle calibrated in degrees of bearing may be made and affixed over the point representing your location on the globe. The 0° mark of this scale should point toward the north pole.

#### A Simplified Direction Finder

A simplified direction finder may be made by removing a globe from its brazen meridian (semi-circular support) and remounting it in the manner shown in Fig. 18-4. Drill a hole that will accept the support at your location on the globe, and another hole directly opposite the first. This second hole will have the same latitude as yours but will be on the other side of the equator (north latitude vs. south latitude). Its longitude will be opposite in direction from yours from the Greenwich or 0° meridian, east vs. west, and will be equal to 180° minus your longitude. For example, if your location is 42° N. lat., 72° W. long., the point opposite yours on the globe is 42° S. lat., 180 - 72 or 108° E. long.

Once the holes are drilled, remount the globe with your location in the position formerly occupied by the north pole. By rotating the globe until the distant point of interest lies beneath the brazen meridian, this support may be used to indicate the great-circle path. A new "equator" calibrated in a

manner to indicate the bearing may be added with India ink, as shown in Fig. 18-4, or a small protractor-like scale may be added at the top of the globe, over your location. A distance scale can be affixed to the brazen meridian so that both the bearing and distance to other locations may be readily determined (12,500 miles or 40,000 km to the semicircle).

### DIRECTION AND DISTANCE BY TRIGONOMETRY

The methods to be described will give the bearing and distance as accurately as one cares to compute them. All that is required is a table of latitude and longitude information, such as may be found in an atlas or almanac, and a set of trigonometry tables. For most purposes, the latitude and longitude can be taken from maps of the areas in question.

#### Direction Calculations

With this method, the bearing or direction to a distant location may be determined without the need to calculate the distance. This procedure is based on information supplied by Larry Price, W4DQD, and on suggestions of Dennis Haarsager, WAØKKR. Two formulas are used:

$$\tan \phi = \cos L \cot B \tag{1}$$

$$\cot C = \frac{\cot L \cos (A + \phi)}{\sin \phi} \tag{2}$$

where *A* = your latitude in degrees  
*B* = latitude of the other location in degrees



Fig. 18-4 — A simple direction finder made by modifying a globe. Bearing and distance to other locations from yours may be determined quickly after modification, no calculations being required.

TABLE 18-II				
Algebraic Signs of Functions of Angles				
Angle	Sin	Cos	Tan	Cot
0° to 90°	+	+	+	+
90° to 180°	+	-	-	-
0° to -90°	-	+	-	-
-90° to -180°	-	-	+	+

$L$  = your longitude minus that of the other location (algebraic difference). If the resultant number is outside the range between  $\pm 180^\circ$ , algebraically subtract or add 360, whichever gives a resultant value between +180 and -180 degrees.

$\phi$  = an intermediate angle used in the procedure.

$C$  = the quadrant bearing angle. (This quadrant angle may be converted to the true bearing angle in degrees clockwise from north by applying the correction as indicated in Table 18-III.)

In using these equations, northerly latitudes are taken as positive, and southerly latitudes are taken as negative. Also, westerly longitudes are taken as positive, and easterly longitudes are taken as negative. In all calculations, the appropriate signs are to be retained, and all additions and subtractions throughout the procedure are to be made algebraically. When using the trig tables, it should be noted that the various functions may be positive or negative in value, depending on the angle for which they are taken. The algebraic signs are not included in the body of the mathematical tables, but must be added when substituting numbers into the equations. Table 18-II may be used for ready reference in assigning algebraic signs.

The following example will show how the formulas are used. To find the bearing from Seattle, Washington, U.S.A., to Sydney, New South Wales, Australia:

From the almanac or map:

Seattle -  $47^\circ 37'$  N. lat.,  $122^\circ 20'$  W. long.

Sydney -  $33^\circ 54'$  S. lat.,  $151^\circ 12'$  E. long.

Fig. 18-5 shows the nature of this example and the various terms which are used in the equations. The location of Seattle is represented by Point A, and Sydney by Point B.

Values for use in the equations are as follows:

$$A = \text{lat. } A = +47^\circ 37'$$

$$B = \text{lat. } B = -33^\circ 54', \text{ and from tables, } \cot B = -1.4882$$

$$L = \text{long. } A - \text{long. } B = +122^\circ 20' - (-151^\circ 12') = +273^\circ 32'. \text{ Subtracting } 360 \text{ to bring this value into the proper range, we obtain a value of } -86^\circ 28' \text{ for } L. \text{ From tables, } \cos L = 0.0616, \text{ and } \cot L = -0.0617$$

Substituting into Eq. 1,

$$\tan \phi = 0.0616 \times (-1.4882) = -0.0917$$

$$\phi = -5^\circ 14' \text{ (}\phi \text{ is always between } -90^\circ \text{ and } +90^\circ \text{)}$$

From tables,  $\sin \phi = \sin (-5^\circ 14') = -0.0912$ .

Then, substituting into Eq. 2,

$$\cot C = \frac{(-0.0617 \times \cos [47^\circ 37' + (-5^\circ 14')])}{-0.0912}$$

$$= \frac{(-0.0617) \times \cos (47^\circ 37' - 5^\circ 14')}{-0.0912}$$

$$= \frac{(-0.0617) \times \cos 42^\circ 23'}{-0.0912} = \frac{(-0.0617) \times 0.7387}{-0.0912}$$

$$= +0.4998$$

$$C = +63^\circ 27' \text{ (} C \text{ is always between } -90^\circ \text{ and } +90^\circ \text{)}$$

The true bearing may now be determined. In this case, the final resultant value of  $L$  is negative, and the value for  $C$  is positive. From Table 18-III the true bearing is therefore  $C + 180^\circ = 243^\circ 47'$ .

In Eq. 1, values for  $\phi$  cannot be determined if location B is on the equator. In such cases,  $\phi$  may be taken as  $+90^\circ$ , which is suitable for any values of  $L$  and  $A$ . Little practical difference will result if the location of B is taken as being a slight distance away from the equator.

### Distance Calculations

The distance between two locations may be determined from the formula:

$$\cos D = \sin A \sin B + \cos A \cos B \cos L \tag{3}$$

where the definitions for  $A$ ,  $B$ , and  $L$  are the same as above, and  $D$  = distance along the path in degrees of arc, as shown in Fig. 18-5. For the Seattle to Sydney example:

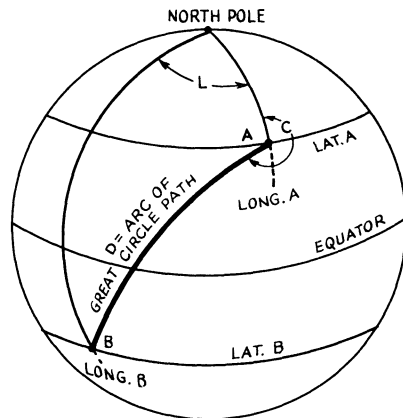

Fig. 18-5 - Showing the various terms used in the equations for determining bearing and distance. North latitudes and west longitudes are taken as positive, while south latitudes and east longitudes are taken as negative.



TABLE 18-III

## Corrections to Determine True Bearing Angle

<i>If</i>	<i>And</i>	<i>Then true bearing is:</i>
$L$ is +	$C$ is +	$C + 0^\circ$
$L$ is +	$C$ is -	$C + 180^\circ$
$L$ is -	$C$ is +	$C + 180^\circ$
$L$ is -	$C$ is -	$C + 360^\circ$

$A = 47^\circ 37'$ , and from tables,  
 $\sin A = 0.7387$ , and  $\cos A = 0.6741$

$B = -33^\circ 54'$ , and from tables,  
 $\sin B = -0.5577$ , and  $\cos B = 0.8300$

$L$  and  $\cos L$  have already been determined:  $\cos L = 0.0616$ .

Substituting into Eq. 3:

$$\cos D = 0.7387 \times (-0.5577) + 0.6741 \times 0.8300 \times 0.0616$$

$$= -0.4120 + 0.0345 = -0.3775$$

$$D = 112^\circ 11'$$

Note: From Table 18-II it may be seen that  $D$ , the angle having a cosine of  $-0.3775$ , must lie either between 90 and 180 degrees, or between  $-90$  and  $-180$  degrees.  $D$  is always taken as positive.

Each degree along the path equals 60 nautical miles, and each minute equals one nautical mile. Therefore,  $112^\circ 11'$  of arc is equivalent to  $60 \times 112 + 11 = 6720 + 11 = 6731$  nautical miles. To convert to statute miles, multiply by 1.1508. If the distance is desired in kilometers, multiply nautical miles by 1.852. Doing this, we learn that the distance between Seattle and Sydney is 7746 statute miles, or 12,466 km. Similarly, the direction and distance between any two points on the earth can be computed.

These equations give information for the great-circle bearing and distance for the shortest path. For long-path work, the bearing will be  $180^\circ$  away from the answers obtained.

## Bibliography

Source material and more extended discussions of topics covered in this chapter can be found in the references given below.

Davis, "A Simplified Direction Finder," Hints and Kinks, *QST*, May, 1972.

Hall, "Bearing and Distance Calculations by Sleight of Hand," *QST*, August, 1973.

Klopf, "A Bearing and Distance Calculator," *QST*, March, 1971.

Norton, *Norton's Star Atlas and Reference Handbook*, Gall and Inglis, London, England; also published in the U.S. by Sky Publishing Corp., Cambridge, Mass.



## INDEX

- A**
- Absorption . . . . . 16, 17, 20, 189  
 Adjusting Parasitic Arrays . . . . . 156  
 Adjustment of Matching Circuits . . . . . 100  
 Admittance . . . . . 120, 125, 291  
 Admittance Coordinates, Smith Chart . . . . . 79  
 Air-Insulated Lines . . . . . 88  
 Alignment of Lobes, Rhombic . . . . . 177  
 Angle, Critical . . . . . 15  
 Angles of Arrival, Vertical . . . . . 18, 19  
 Antenna  
   Beverage or Wave . . . . . 294  
   Bob-Tail Curtain . . . . . 300  
   Capacitance, Lumped . . . . . 191  
   Collinear-Coaxial . . . . . 247  
   Combination J-Pole . . . . . 246  
   Conical Monopole . . . . . 299  
   Current Distribution . . . . . 25  
   DDRR . . . . . 214  
   Delta Match . . . . . 227  
   Elements . . . . . 132  
   Element Phase . . . . . 132  
   Five-Band, Trap Dipole . . . . . 185  
   Folded Dipole . . . . . 195  
   Four-Element Yagi, 15 Meter . . . . . 203  
   Gamma Match . . . . . 203, 228  
   Grounding Systems . . . . . 61  
   Impedance . . . . . 27  
   Interlaced Yagi . . . . . 204  
   Inverted V . . . . . 192  
   Inverted-V Dipole . . . . . 196  
   Isotropic . . . . . 132  
   J . . . . . 227  
   L and T . . . . . 192  
   Length of Half-Wave . . . . . 26  
   Log-Periodic Dipole Array . . . . . 208  
   Multitee . . . . . 299  
   Multi-Band . . . . . 170  
   Non-Resonant Rhombic . . . . . 173  
   Off-Center Feed . . . . . 182  
   Q . . . . . 30, 148, 151  
   Quad . . . . . 158  
   Random Height and Length Wire . . . . . 178  
   Range/Measurement . . . . . 317-322  
   Reactance . . . . . 30  
   Receiving Loop, 160 Meter . . . . . 193  
   Remote Switching . . . . . 201  
   Resonance . . . . . 112  
   Resonance in Helically Wound . . . . . 222  
   Resonant Rhombic . . . . . 171  
   Shielded Loop . . . . . 193  
   Shortened Yagi . . . . . 217  
   Stacked 50-MHz Array . . . . . 233  
   Stacking . . . . . 204, 224  
   Standard-Gain . . . . . 320  
   System, Design of . . . . . 7  
   T-Match . . . . . 226, 228  
   Three-Band Quad System . . . . . 205  
   Three-Element Monoband . . . . . 205  
   Trap Verticals . . . . . 187  
   V . . . . . 169  
   Vertical Noise Pickup . . . . . 202  
   VHF and UHF Systems . . . . . 224  
   Voltage Distribution . . . . . 25  
   Windom . . . . . 182  
   Y Match . . . . . 227  
   Yagi, Helically Wound . . . . . 219  
   15-Meter Four-Element . . . . . 203  
   20 and 15 Meter Interlaced . . . . . 204  
   40-Meter Loop . . . . . 198  
   40-Meter Short Beam . . . . . 220  
   40-Meter Sloper . . . . . 200  
   40-Meter Vertical, 6-Foot . . . . . 213  
 Antenna as a Circuit . . . . . 28  
 Antenna Capacitance, Mobile . . . . . 288  
 Antenna Counterweight . . . . . 272  
 Antenna Construction  
   Insulation . . . . . 266  
   Insulator Stress . . . . . 266  
   Materials . . . . . 264  
   Wire . . . . . 264  
 Antenna Current/SWR . . . . . 306  
 Antenna Rotator . . . . . 218  
 Antenna Support, Trees . . . . . 271, 273  
 Antenna Supports, Wire . . . . . 270  
 Antenna System Losses . . . . . 190  
 Antennas  
   Broadside . . . . . 295  
   Broadside and Endfire Arrays . . . . . 296  
   Bruce Array . . . . . 297  
   Center-Fed Multiband . . . . . 179  
   Continuously Loaded . . . . . 290  
   Corner Reflector . . . . . 241  
   Coupled . . . . . 30  
   Crossed Linear . . . . . 250  
   Crossed Yagi . . . . . 250, 251  
   Direction Finding . . . . . 293  
   Directly Fed . . . . . 178  
   Discone . . . . . 298  
   Element Lengths and Spacing, VHF . . . . . 225  
   End-Fed . . . . . 179  
   Fishbone . . . . . 294  
   Folded Dipole . . . . . 65, 66  
   Ground Plane . . . . . 62, 63  
   Ground Reflection Factor . . . . . 45  
   Grounded . . . . . 59  
   Half-Wave Loops . . . . . 64  
   Half-Wavelength . . . . . 195  
   Harmonic Operation . . . . . 31  
   Harmonic, Power Gain of . . . . . 43  
   Helical . . . . . 250  
   Helical, VHF . . . . . 260  
   Helically Wound . . . . . 290  
   HF, Restricted Space . . . . . 211  
   Image . . . . . 44  
   Impedance of Harmonic . . . . . 32  
   Indoor Systems . . . . . 212  
   Invisible . . . . . 211  
   Long-Wire . . . . . 165  
   Long-Wire, Radiation Resistance . . . . . 44  
   Long-Wire, VHF . . . . . 239  
   Loop . . . . . 64, 293  
   Mobile . . . . . 287  
   Mobile HF . . . . . 287  
   Multiband . . . . . 178, 195  
   Multiband Vertical . . . . . 186  
   Multielement Array . . . . . 247  
   Multiple Dipole . . . . . 183  
   Non-Resonant Long-Wire . . . . . 171  
   One-Wavelength Loops . . . . . 65  
   Phased Vertical . . . . . 197  
   Physically Shortened Dipoles . . . . . 212  
   Quad, Directive Patterns and Gain . . . . . 159  
   Quadhelix, 1296 MHz . . . . . 261  
   Receiving, Impedance Matching . . . . . 317  
   Rotatable . . . . . 277  
   Rotating Systems . . . . . 280  
   Screen-Reflector Arrays . . . . . 241  
   Short Helically Wound Vertical . . . . . 221  
   Short Vertical . . . . . 186, 213  
   Space Communications . . . . . 250  
   Specialized . . . . . 293  
   Step-Up Ratio, Folded Dipole . . . . . 66  
   Sterba Array . . . . . 297  
   Textbooks . . . . . 67  
   Tilted-Wire . . . . . 168  
   Top Loading . . . . . 61, 62  
   Two- and Four-Bay Arrays . . . . . 244  
   Vertical . . . . . 196  
   Vertical Polarization . . . . . 244  
   VHF Non-Directional . . . . . 245

3.5 and 7 MHz	195
14, 21, and 28 MHz	202
50 MHz	231, 232, 233, 239
144 MHz	234, 235, 236, 238, 239, 240
220 and 420 MHz	240
160 Meter Receiving	193
Arrester, Lightning	271
Atmospheric Ducts	13
Attenuation	9, 81
Aurora	21
Az-El Mount, Yagis	253

## B

Backscatter	22
Balun	
102, 103, 113, 114, 115, 221, 228, 230, 248, 317	
Bandwidth	148, 151
Base Loading, Mobile	287
Bazooka	228
Beam, W8JK	143
Beamwidth	131, 132
Bearings from Globe	327
Bending, Wave	10, 15
Beta Match	121
Beverage Antenna	294
Bi-Directional Array	131
Block and Tackle	268
Boom Size, Yagi or Quad	277
Braces/Suspension	234
Bridge Circuits	303
Bridge, RF Impedance	312
Broadside Array	131
Broadside Arrays	137

## C

Capacitive Hat	191
Capture Area	317
Center Loading, Calculation of Value	291
Center Loading, Mobile	287
Chart	
Antenna Height vs. Wave Angle	49
Attenuation, Transmission Lines	93
Beamwidth, Arrays	155
Capacitance, Sphere, Disk, & Cylinder	62
Characteristic Impedance	88, 89
Gain, Broadside Array	138
Gain, Collinear Array	135
Gain, End-Fire Array	140
Gain/Number of Elements	153
Gain of Long-Wire Antenna	165
Line Loss	82
Off-Center Loaded Dipoles	212
Optimum Length of Array	154
Optimum Spacing for Stacking	156
Parabolic-Antenna Gain	258
Parabolic Reflector Error	258
Radiation Angles, Long-Wire	166
Radiation Resistance, Collinear Array	134
Radiation Resistance, Variation with Height	50
Radiation Resistance vs.	
Vertical Antenna Height	60
Reactance, Vertical Antenna vs. Height	61
Transmission Line Data	91
Vertical Directivity	57
Wave Angle vs. Antenna Height	49
Yagi and Quad Compared	159
Yagi Element Length	204
Charts, Prediction	23
Circular Polarization	250
Coax-Line RF Choke	115, 116
Coaxial Fittings	92
Coaxial Fittings, Assembly Instructions	94, 95
Coaxial Lines	89
Coaxial Lines, Stubs	124

Collinear Arrays	135
Collinear Arrays, 144 MHz	236
Combination Driven Arrays	142
Combining Vertical and Horizontal Conductors	187
Communication, Long-Path	19
Communication, Short-Path	19
Conductance	79, 120, 128
Conjugate Match	317
Construction, All-Metal	237
"Control Points"	18
Counterpoise	190
Coupled Antennas	30
Couplers	230
Coupling Line to Antenna	104
Coupling, Mutual	133
Coupling Transmitter to Lines	96
Crank-Up Tower	284
Critical Angle	15
Critical Frequencies	20
Critical Frequency	16
Crossed Yagi	250
Current	
Loop	25
Node	25
Current and Voltage Feed	105
Current Flow in Long Lines	69
Currents, Earth	190
Curtain Array, 144-MHz	237
Cycle, Sunspot	14

## D

D Region	14
Decibel	43
Delta Matching	116, 117
Design	
Antenna System	7
Log-Periodic Array	161
Designing Stub Matches with Smith Chart	125
Detuning Sleeves	115
Dielectric Constant	10
Dielectric, Earth	11
Diffraction	9, 10
Direct Matching	113
Direct Ray	10
Direction/Distance by Trigonometry	327
Direction Finding	293
Direction Finder, Simplified	327
Directional Antennas, Sloper	200
Directional Indicator	282
Directional Patterns	148
Directivity	36, 41, 57, 135, 138
Directivity, Long-Wire	166
Directors, VHF	239
Distance	
Line-of-Sight Propagation	11, 12
Skip	15, 189
Transmission, Long	18
Transmission/Layer Height	17
Disturbances, Sudden Ionospheric	21
"Diversity" Reception	20
Driven Array	131
Driven Arrays	134
Driven Elements	131
Driven Element Length	226
Ducts, Atmospheric	13

## E

E Layer	17, 18
E Region	14
Earth Currents	190
Earth, Dielectric	11
Effective Aperture	317
Electric Fields	7, 8, 9

- Electric Force, Lines of . . . . . 8, 9  
 Electrical Length . . . . . 26, 92  
 Electromagnetic Waves . . . . . 7, 24, 35  
 Element Length Adjustment . . . . . 226  
 Element Lengths and Spacings . . . . . 227  
 End Effect . . . . . 27  
 End-Fed Antenna . . . . . 179  
 End-Fire Array . . . . . 131  
 End-Fire Arrays . . . . . 139  
 Extended Double Zepp . . . . . 137
- F**
- F Layer . . . . . 17, 18  
 F Region . . . . . 15  
 Fading . . . . . 20  
 Fading, Selective . . . . . 20  
 Feed-Horn . . . . . 255, 256  
 Feed Horn, Backfire Type . . . . . 257  
 Feed Horn, 1296 MHz . . . . . 257  
 Feed-Line Radiation . . . . . 180  
 Feed-Point Mismatch . . . . . 317  
 Feed System, 2287.5 MHz . . . . . 259  
 Feed-Through Connectors . . . . . 271  
 Feeder-to-Transmitter Matching Networks . . . . . 180  
 Feeding Long-Wires . . . . . 168  
 Field Intensity . . . . . 9  
 Field Strength . . . . . 9, 24, 130  
 Field-Strength Measurement . . . . . 157  
 Fields  
   Electric . . . . . 7, 9  
   Electric and Magnetic . . . . . 9  
   Magnetic . . . . . 7, 9  
   Magnetic and Electric . . . . . 7  
 Finding Directions . . . . . 323  
 Finding Directions, by Sun . . . . . 324  
 Five-Band Antenna, Trap Dipole . . . . . 185  
 Flares, Solar . . . . . 21  
 Flexible Lines . . . . . 90  
 Flexible Sections for Rotatable Arrays . . . . . 126, 127  
 Folded Dipole . . . . . 117, 229  
 Folded Dipole, Step-Up Ratio . . . . . 66  
 Formula  
   Directivity . . . . . 41  
   Field Strength . . . . . 41  
   Gain . . . . . 42, 132, 321  
   Half-Wave . . . . . 225  
   Length, Long-Wire . . . . . 167  
   SWR . . . . . 85  
 Fot . . . . . 17  
 Four-Band Trap Dipole . . . . . 186  
 Four-Element Arrays . . . . . 152  
 Four-Wire Lines . . . . . 89  
 "Free" Space . . . . . 7, 8, 9, 11  
 Free-Space Radiation Resistance . . . . . 29  
 Frequency  
   Critical . . . . . 16, 20  
   Lowest Usable . . . . . 17  
   Maximum Usable . . . . . 16  
   Optimum Working . . . . . 17  
 Frequency Predictions . . . . . 23  
 Frequency Range and SWR . . . . . 104  
 Front-to-Back Ratio . . . . . 147, 150
- G**
- Gain . . . . . 135, 138  
 Gain  
   Broadside Array . . . . . 143  
   Combination Arrays . . . . . 142  
   Parabolic Antenna . . . . . 257  
   Quad Antenna . . . . . 159  
   Rhombic Antenna . . . . . 175  
   Three-Element Beam . . . . . 149, 150  
   Two-Element Parasitic Array . . . . . 146  
 Gain/Effective Aperture . . . . . 318  
 Gain Formula . . . . . 321  
 Gain/Mutual Impedance . . . . . 133  
 Gamma Dimensions . . . . . 119, 120  
 Gamma Match . . . . . 118, 228, 231, 251  
 Gin Pole . . . . . 276, 284, 285  
 Great-Circle Path . . . . . 18, 19  
 Ground Effects . . . . . 43, 132  
 Ground Plane . . . . . 190, 191, 196, 202, 215, 245  
 Ground-Plane Antennas . . . . . 126, 128  
 Ground Reflection Factor . . . . . 45  
 Ground Reflection/Radiation Resistance . . . . . 47  
 Ground Screens . . . . . 48  
 Ground System . . . . . 198  
 Ground Wave . . . . . 10-12, 109  
 Guy Anchors . . . . . 275, 284  
 Guy Material . . . . . 275
- H**
- Hair-Pin Match . . . . . 121  
 Half-Wave Dipoles . . . . . 202  
 Halyards . . . . . 267  
 Harmonic Operation . . . . . 25, 106  
 Harmonic Wire, Length of . . . . . 32  
 Heat Losses . . . . . 29  
 Helically Wound Vertical . . . . . 190
- I**
- Impedance  
   Helically-Wound Vertical . . . . . 222  
   Input . . . . . 150  
   Mutual . . . . . 133, 134  
   Plotting, Smith Chart . . . . . 77  
   Step-Up . . . . . 115  
   Transformation . . . . . 86  
 Impedance, Rhombic Antenna . . . . . 176  
 Impedance Bridge . . . . . 312  
 Impedance Matching, Receiving Antennas . . . . . 35  
 Incident Power . . . . . 71  
 In-Line RF Wattmeter . . . . . 306-310  
 Input Impedance, Line . . . . . 74  
 Input Impedances, Smith Chart Determination of . . . . . 87  
 Insulator Leakage . . . . . 266  
 Insulators, Ribbon Line . . . . . 267  
 Inversion, Temperature . . . . . 13  
 Ionosphere . . . . . 14  
 Ionosphere Variations . . . . . 19  
 Ionospheric  
   Control Points . . . . . 18  
   Predictions . . . . . 23  
   Refraction . . . . . 15  
   Scatter . . . . . 21  
   Storms . . . . . 20  
 Isotropic Antenna . . . . . 132  
 Isotropic Radiator . . . . . 36
- L**
- LaPort Rhombic . . . . . 240  
 Layer Characteristics . . . . . 14  
 Layer Height/Transmission Distance . . . . . 17  
 Lazy-H Array . . . . . 143  
 Length/Diameter Ratio . . . . . 27  
 Light, Speed of . . . . . 7  
 Lightning Grounds . . . . . 270  
 Lightning Protection . . . . . 270  
 Line  
   Length, Determination of Electrical . . . . . 81  
   Loss, Considerations with Smith Chart . . . . . 83  
   Radiation . . . . . 105  
 Line Current/Voltage, Coaxial . . . . . 301  
 Line-of-Sight Propagation . . . . . 11, 12  
 Line Sampler . . . . . 310-312  
 Linear Polarization . . . . . 250

Lines as Circuit Elements . . . . .	86		
Lines			<b>O</b>
Electric and Magnetic Force . . . . .	8	Off-Center Feed, Windom . . . . .	182
Of Force, Electric . . . . .	9	Omega Match . . . . .	120, 121
Loading Coil, Mobile . . . . .	287	"One-Way" Skip . . . . .	20
Loading Coil Design . . . . .	289	Open-Wire Line . . . . .	268
Loading Coils . . . . .	190, 211, 217, 218	Open Wire Line/Antenna Connection . . . . .	269
Log-Periodic Dipole Array . . . . .	160	Open-Wire Support . . . . .	269
Log Periodic Radiation Pattern . . . . .	163	Optimum Working Frequency . . . . .	17
Long-Distance Transmission . . . . .	18		<b>P</b>
"Long Path", Great-Circle . . . . .	19	Parabolic Dish, Template . . . . .	259
Long Yagis . . . . .	152	Parabolic Dish, Surfacing Materials . . . . .	258
Longwire Antenna, Span and Sag . . . . .	264	Parallel-Conductor Lines . . . . .	90
Losses, Trap . . . . .	184	Parallel/Series Equivalent Circuits . . . . .	75
Lowest Usable Frequency . . . . .	17	Parasitic	
	<b>M</b>	Array . . . . .	131
Macromatcher . . . . .	212, 312	Arrays . . . . .	145
Magnetic		Element . . . . .	131, 226
Fields . . . . .	7, 8, 9	Elements, Self-Resonant . . . . .	147
Storms . . . . .	20, 21	Patterns . . . . .	148
Magnetic Force, Lines of . . . . .	8	Patterns	
Magnetic North . . . . .	323	<i>E</i> and <i>H</i> Planes . . . . .	37
Magnetic Variation . . . . .	323	Graphical Construction . . . . .	40
Major Lobes . . . . .	131	Vertical Directivity . . . . .	57
Maps, Azimuthal . . . . .	326	Phase . . . . .	8
Mast Erection . . . . .	276	Phase and Wavelength . . . . .	8
Masts . . . . .	274	Phase Shift/Reflection . . . . .	11
Masts, A-Frame . . . . .	274	Phased Arrays . . . . .	198
Masts, Guying . . . . .	275	Phased Verticals . . . . .	197
Matching by Length Adjustment . . . . .	127	Phasing . . . . .	144
Matching Circuit, Balanced to Unbalanced . . . . .	229	Phasing Sections . . . . .	226
Matching Network, Tapped-Coil . . . . .	292	Phasing System, 50-MHz . . . . .	235
Matching Networks, Commercial . . . . .	181	Pickup Efficiency . . . . .	294
Matching Networks, Feeder-to-Transmitter . . . . .	180	Plane Wave . . . . .	7, 8
Matching Sections . . . . .	226	Polarization . . . . .	9, 11, 12, 189, 224, 316, 317
Matching Stub . . . . .	114	Polarization	
Matching Stubs . . . . .	122, 123, 124	Circular . . . . .	34, 260
Matching with Lumped Constants . . . . .	126	Elliptical . . . . .	34, 260
Maximum Usable Frequency . . . . .	16	Linear . . . . .	34, 260
Measurement, Field Strength . . . . .	157	Reciprocity, Receiving and Transmitting . . . . .	34
Measurement of Line Input Current . . . . .	101	Sky Wave . . . . .	19
Measurements . . . . .	301	Tropospheric Wave . . . . .	13
Measurements		Pole Star/Polaris . . . . .	324
Absolute Gain . . . . .	320	Power	
Antenna . . . . .	316	Density . . . . .	41
Antenna Test Site . . . . .	317	Gain . . . . .	130
Gain . . . . .	318	Power Absorber . . . . .	305, 316
Macromatcher . . . . .	212	Prediction Charts . . . . .	23
Radiation Pattern . . . . .	318, 320-322	Propagation . . . . .	189
SWR . . . . .	302	Propagation	
SWR Errors . . . . .	305	Line-of-Sight . . . . .	11, 12
Meteor Trails . . . . .	22, 23	Multihop . . . . .	18
Miles to Kilometer Conversion . . . . .	329	Single and Multihop . . . . .	16
Minor Lobes . . . . .	131	Sporadic- <i>E</i> . . . . .	22
Mobile Antenna Tuneup . . . . .	287, 292	Tropospheric . . . . .	13
MUF Determination, Control Point . . . . .	18	Velocity . . . . .	26
MUF Predictions . . . . .	23	Wave . . . . .	7
Multiband Antenna, Traps . . . . .	186	Prop-Pitch Rotor System . . . . .	280
Multiband Antennas, Harmonic Radiation . . . . .	188	Pulleys . . . . .	267
Multielement Directive Arrays . . . . .	130		<b>Q</b>
Multihop Propagation . . . . .	16, 18	<b>Q</b>	
Multiple Tuning . . . . .	191	Antenna . . . . .	128, 148, 151
Mutual		Circuit . . . . .	97, 98
Coupling . . . . .	133	Line Input Impedance . . . . .	98
Impedance . . . . .	133, 134, 146	<i>Q</i> -Section, Adjustable . . . . .	227
Impedance/Gain . . . . .	133	<i>Q</i> vs. SWR . . . . .	129
	<b>N</b>	Quarter-Wave Transformer . . . . .	116
National Electric Code . . . . .	264	Quad Antenna . . . . .	158
Nautical Miles/Statute . . . . .	329	Quad Spreaders . . . . .	207
Noise, Solar Radio, Flux ( $\phi$ ) . . . . .	20	Quad	
Non-Reactive Termination . . . . .	314	Diamond/Square . . . . .	206
Numbers, Sunspot . . . . .	19, 20	Directive Patterns and Gain . . . . .	159, 160







