

The 2018 Cookbook For HF Transmitting Chokes

Jim Brown K9YC

k9yc@arri.net

<http://k9yc.com/publish.htm>

Don't Bother Taking Notes

**These slides will be at
k9yc.com**

First, Some Review

Understanding Common Mode and Differential Mode Currents on Transmission Lines

Differential Mode Current

- **Transmission line carrying power from transmitter to antenna, or from antenna to receiver**
- **Signal is voltage between the two conductors**
- **Current flows out on one conductor and returns on the other**

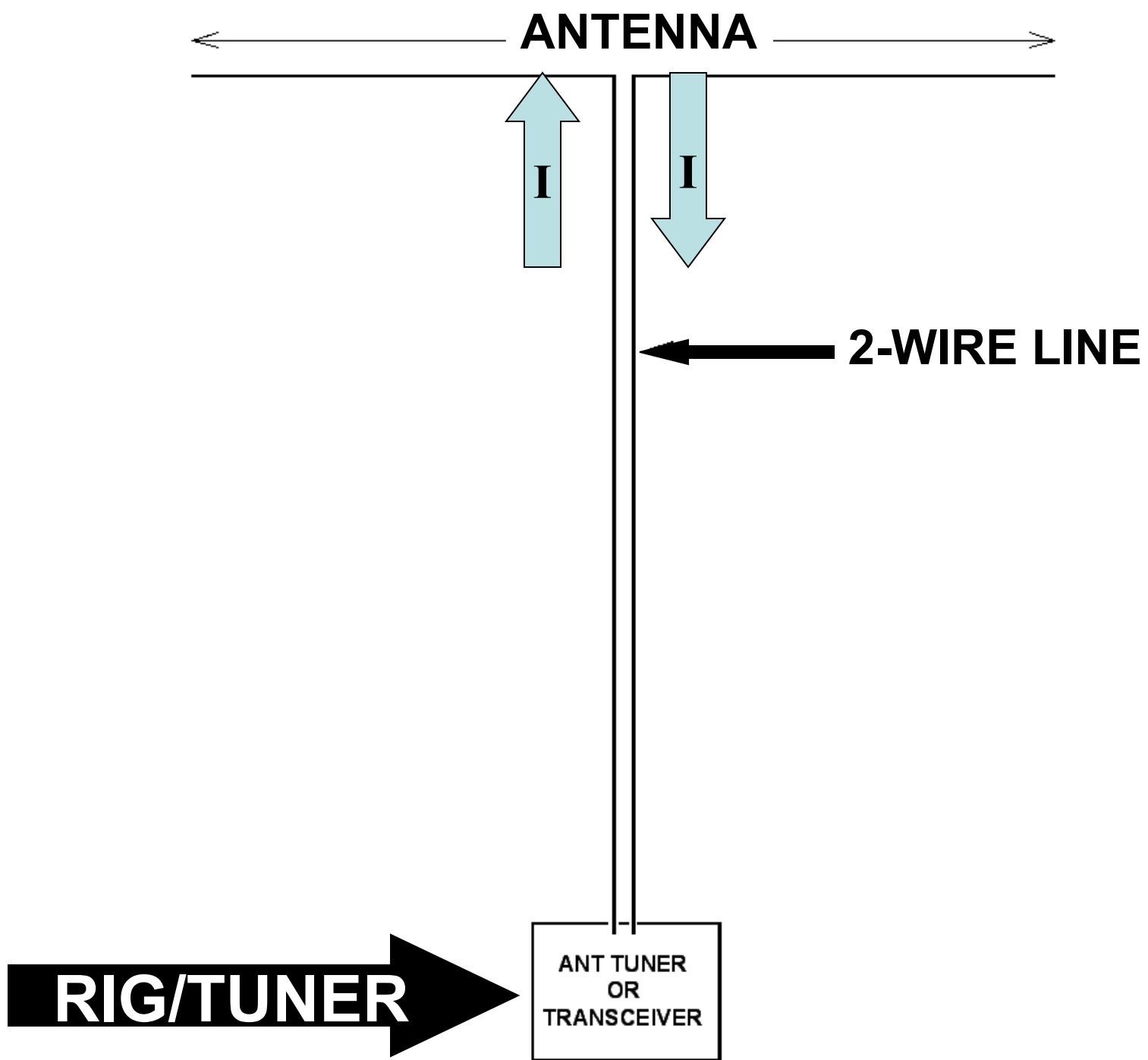

Differential Mode Current

- **Transmission line carries power from transmitter to antenna, or from antenna to receiver**
- **Signal is voltage between the two conductors**
- **Current flows out on one conductor and returns on the other**
- **Fields exist between the two conductors**
- **No radiation from differential current**
 - **Field of outgoing conductor cancels field of return conductor**

Common Mode Current

- **Equal and flowing in the same direction on all conductors of coax or 2-wire line**
- **Current flows lengthwise on the line**
 - **No cancellation of one current by another, because they're in polarity**
- **Line acts as long wire antenna**
 - **It radiates and it receives**

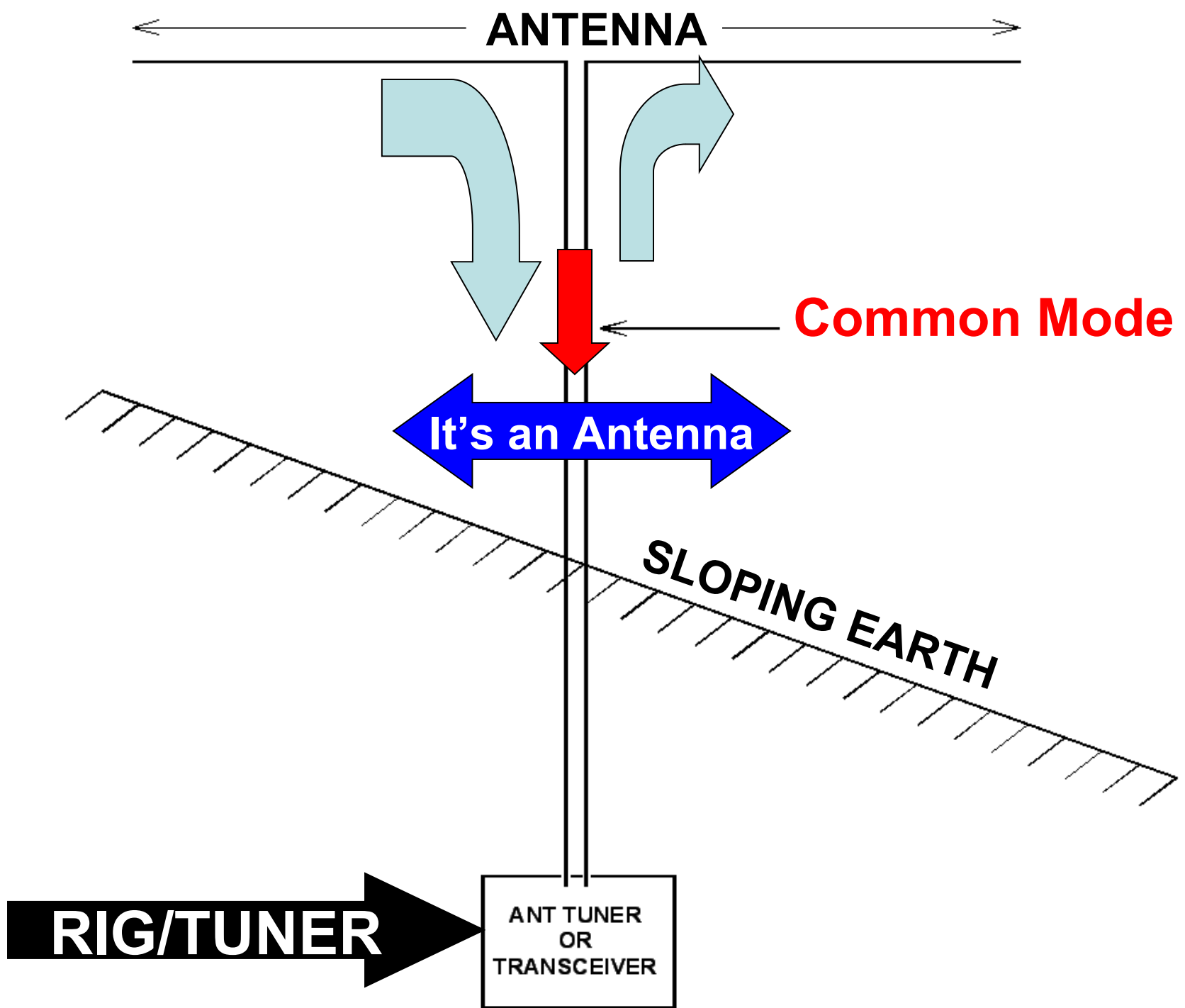

Ham Antennas and Balance

- Many ham antennas are unbalanced by their surroundings, even when fed by a balanced source and 2-wire line

What Makes a Circuit Balanced?

What Makes a Circuit Balanced?

- The impedances of each conductor to the reference plane are equal
- Balance is not defined by voltage or current
- Balance is not defined by a 2-wire feedline or “balanced” tuner
- Imbalanced impedances cause unbalanced currents

Ham Antennas and Balance

- Many ham antennas are unbalanced by their surroundings, even when fed by a balanced source and 2-wire line
 - Unequal capacitances to nearby conductors
 - Unequal inductive coupling to nearby conductors
 - Trees, buildings, towers, terrain
 - Feedline comes off at an angle
 - **Coax is not a part of these imbalances**

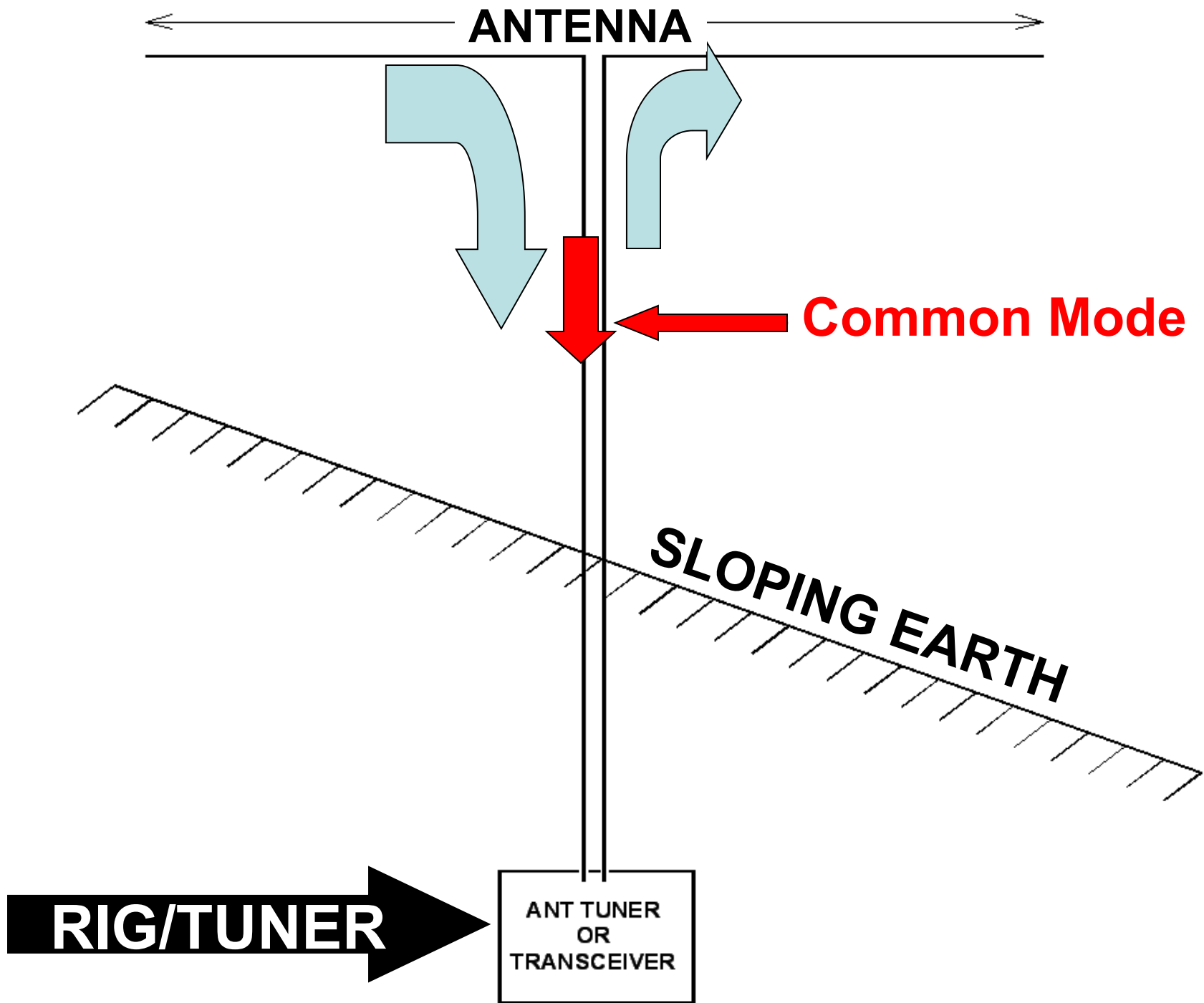

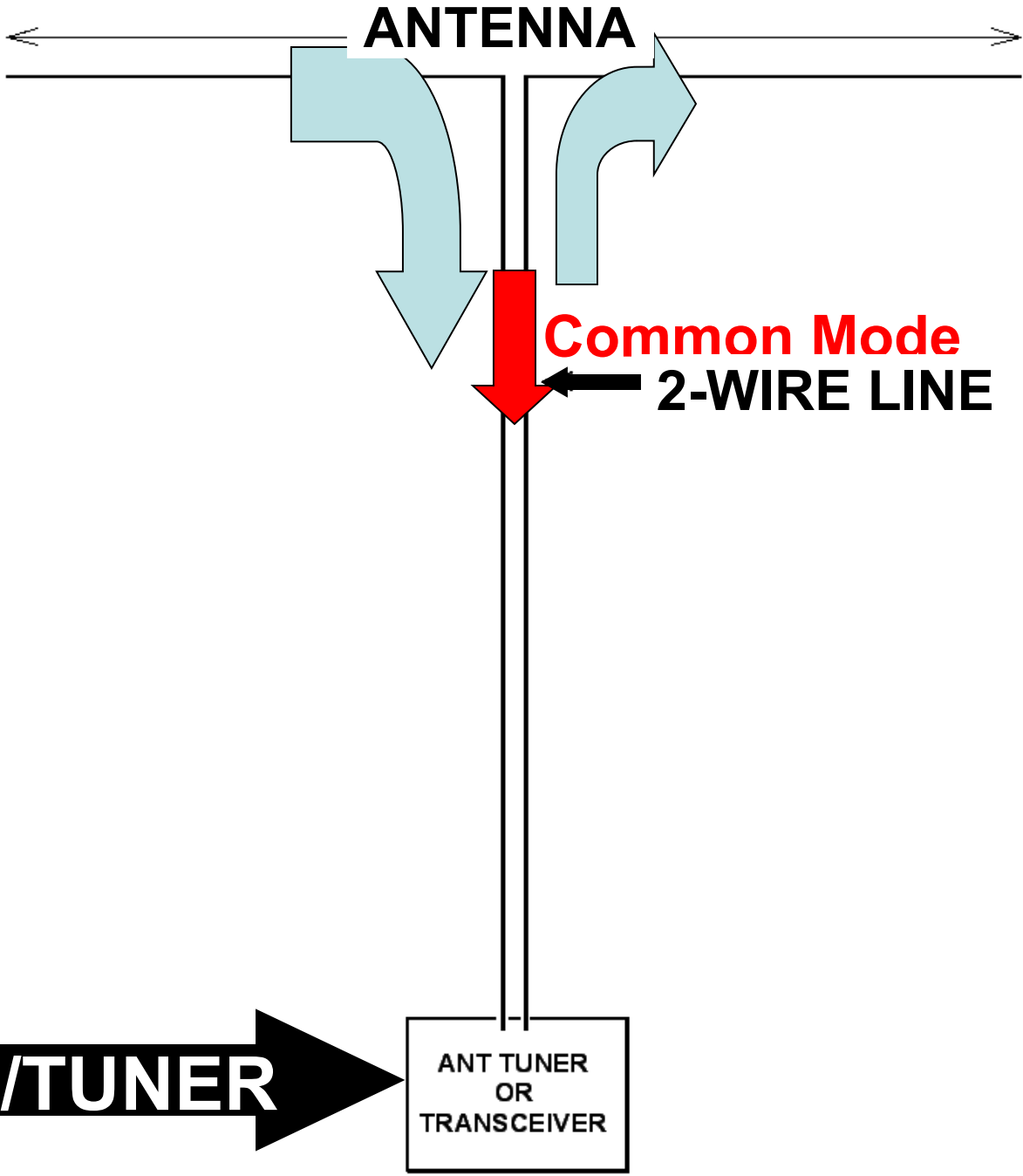
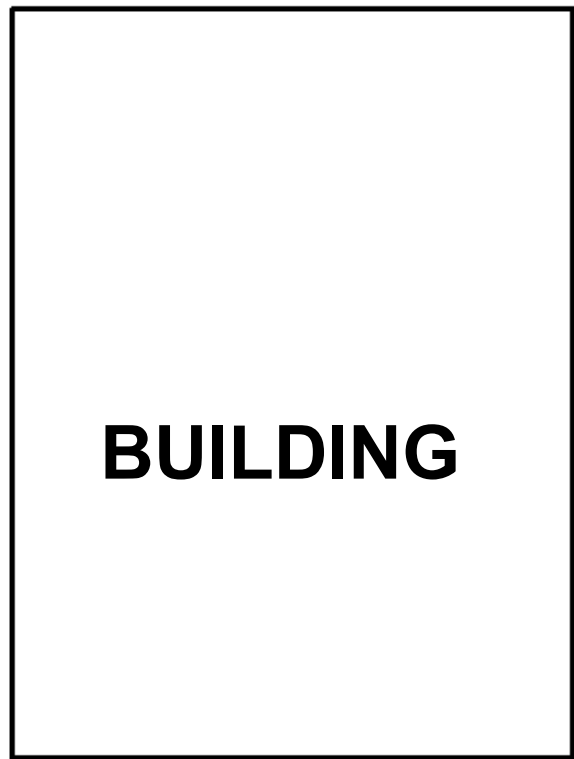

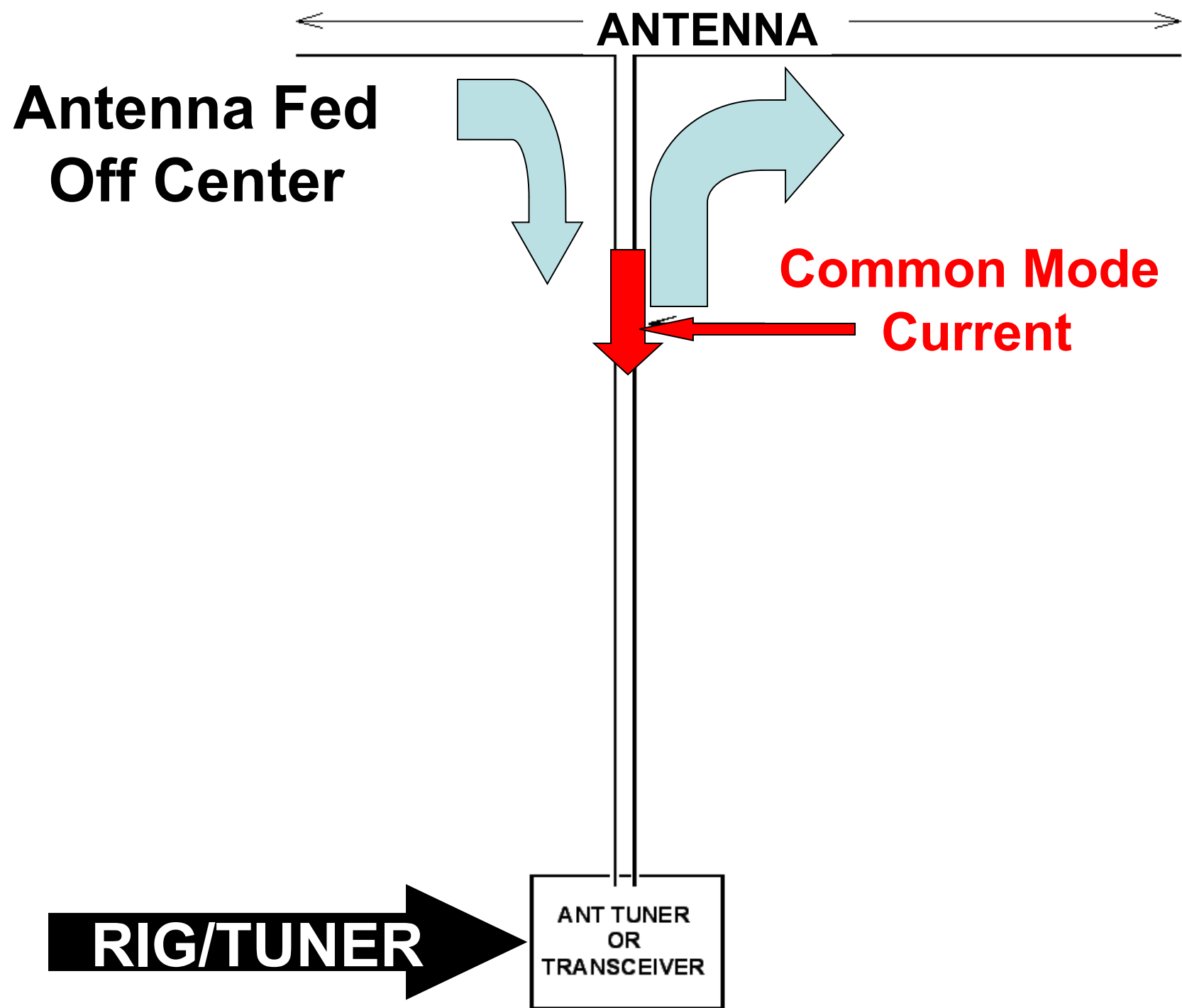

Unbalanced Antennas and Lines

- **If the antenna is unbalanced**
 - Unequal voltage and current to earth
 - Unequal currents on the feedline
 - The difference is common mode current, and it radiates from the line
- **Coax did not cause the imbalance in these antennas!**
- **Coax would simply add to the imbalance**

**The Fields around Coax and
2-Wire Line are Very Different**

Coax is Special

- **Skin effect splits the shield into two conductors**
 - **Inner skin carries differential mode current (the transmitter power, received signal)**
 - **Outer skin carries common mode current (the current due to imbalance)**

Coax is Special

- All the differential power (and field) is confined inside the coax
- All the common mode power (and field) is outside the coax
- A ferrite core surrounding coax sees only the common mode power (and field)

Two-Wire Line

- **Common mode current is the difference of the currents in the two wires**
- **Both currents produce a field**
- **When they are equal and opposite, they cancel, so line does not radiate or receive**
- **When the currents are not equal, the differences in their fields radiates**
- **And by reciprocity, the line receives**

Now We Can Talk About Common Mode Chokes!

What's a Common Mode Choke?

- **A circuit element that reduces common mode current by adding a high impedance in series with the common mode circuit**
 - **Reduces radiation from the line**
 - **Reduces reception by the line**

Some Common Mode Chokes

- **A coil of coax at the antenna**
- **A string of ferrite beads around coax (Walt Maxwell, W2DU)**
- **Multiple turns of transmission line through a toroid (Joe Reisert, W1JR) or stack of toroids (W1HIS, K9YC)**
- **Most 1:1 “baluns” are common mode chokes**
- **Not all are good common mode chokes**

Some Common Mode Chokes

- **Some 2:1, 3:1, and 4:1 “baluns” are also common mode chokes**
 - **Guanella balun**
 - **But the few I’ve measured aren’t very good common mode chokes**

Why Transmitting Chokes?

- **Isolate antenna from its feedline**
- **Reduce receive noise**
- **Keep RF out of the shack**
- **Minimize antenna interaction**
 - **Field Day**
 - **SO2R, Multi-transmitter stations**
 - **Dipole feedline and vertical antenna**

ANTENNA

Without a good choke, common mode current makes the feedline part of the antenna



Receive Noise



Common Mode Current

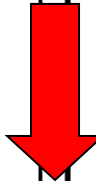

RF in the Shack

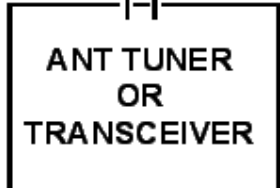

←————— ANTENNA —————→

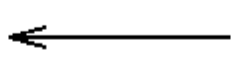
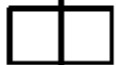

**FIRST CHOKE
ALWAYS GOES HERE**



FEEDLINE

**THE ONLY GOOD
PLACEMENT TO KILL
RX NOISE AND TX
COMMON MODE**

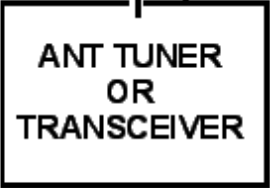

RIG/TUNER

Why Is This True?

- In the common mode circuit, the feedline is simply another wire that is part of the antenna
- It's NOT a simple series circuit
- A good choke at the feedpoint breaks the connection of the feedline to the antenna in the common mode circuit, so that it's no longer part of the antenna -- it's only a feedline
- A choke anywhere else does not!

How Chokes Work

- **Their high resistance forces (near) zero current at the point where it is installed, just like current is near zero at the ends of wire dipole**
- **RF current can still be induced in the feedline below the choke, but it can't couple to the antenna, then down to the shack as a differential signal within the feedline**
 - **Unless grounding and bonding in the shack is missing or done wrong!**

**Egg Insulators
In Tower Guys
at WBZ
(50kW
1020 kHz)**

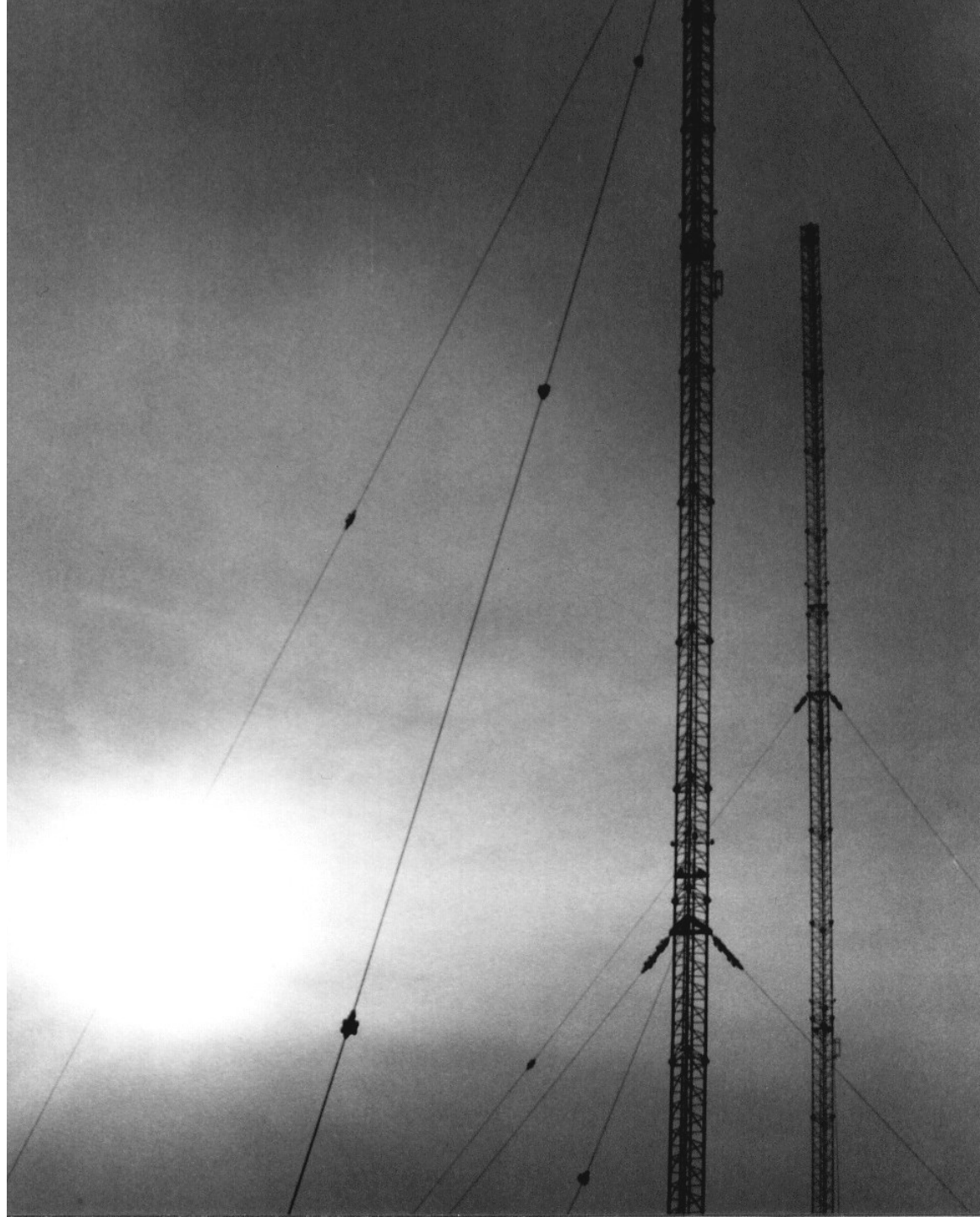

A Choke As An Egg Insulator

- We use egg insulators in tower guys so that they won't act as parasitic elements to nearby antennas (on the tower or not), changing their patterns**
- A feedline to a dipole can act as a parasitic element to a nearby vertical**
- A good choke can act as an egg insulator, preventing the interaction**
- I use them this way to prevent interaction with my 160 Tee vertical**

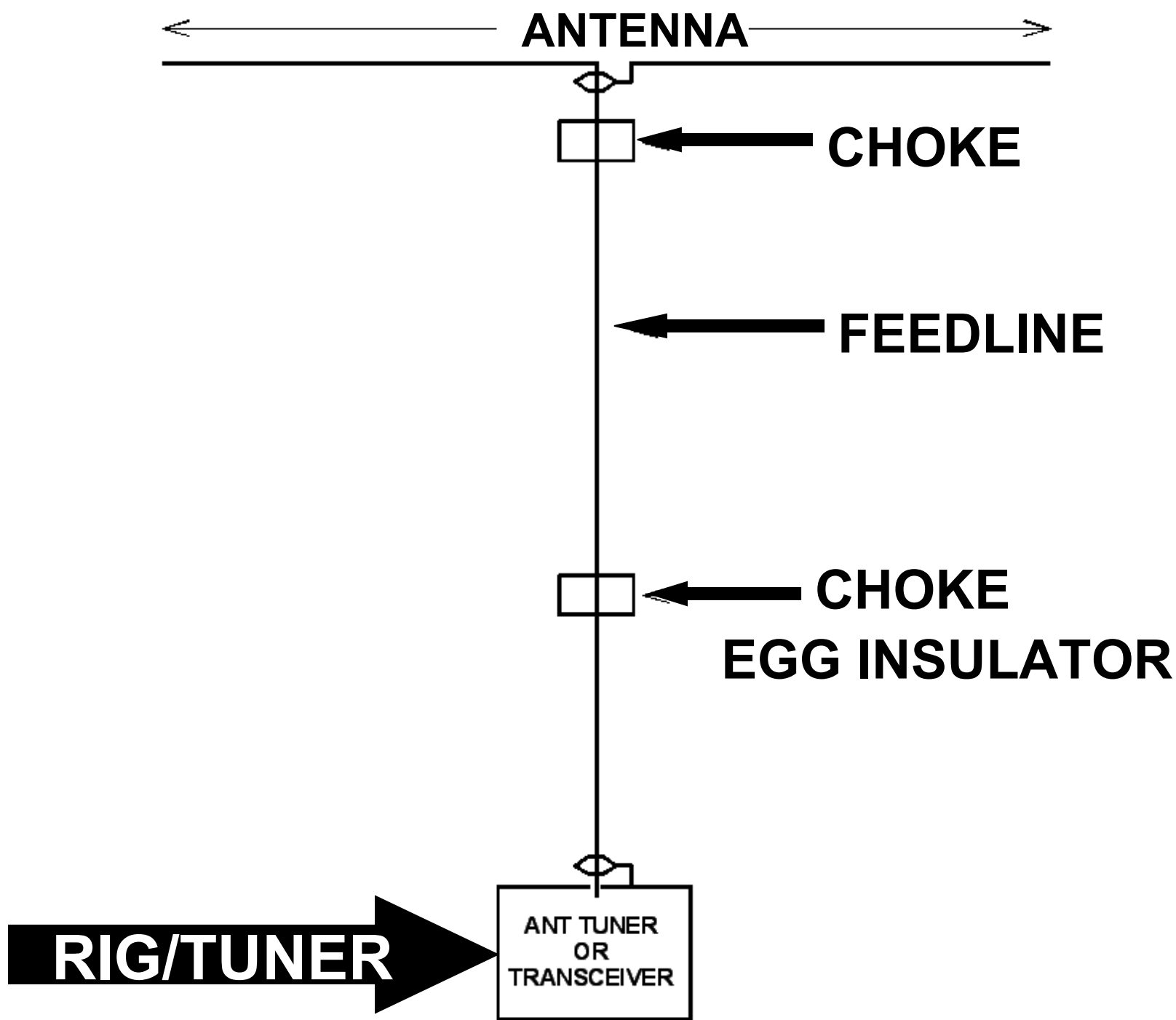

What's "Nearby?"

- **My 120 ft tower with antennas on top acts as a reflector for that Tee vertical, giving me 2 dB or so to the south, and making me 3 dB weaker to the north!**
- **And if I short the base of the Tee with a suitably placed stub, it acts as a reflector for the sloping verticals rigged to the tower, pushing their patterns to the north**
- **The tower and the Tee are 210 ft apart!**

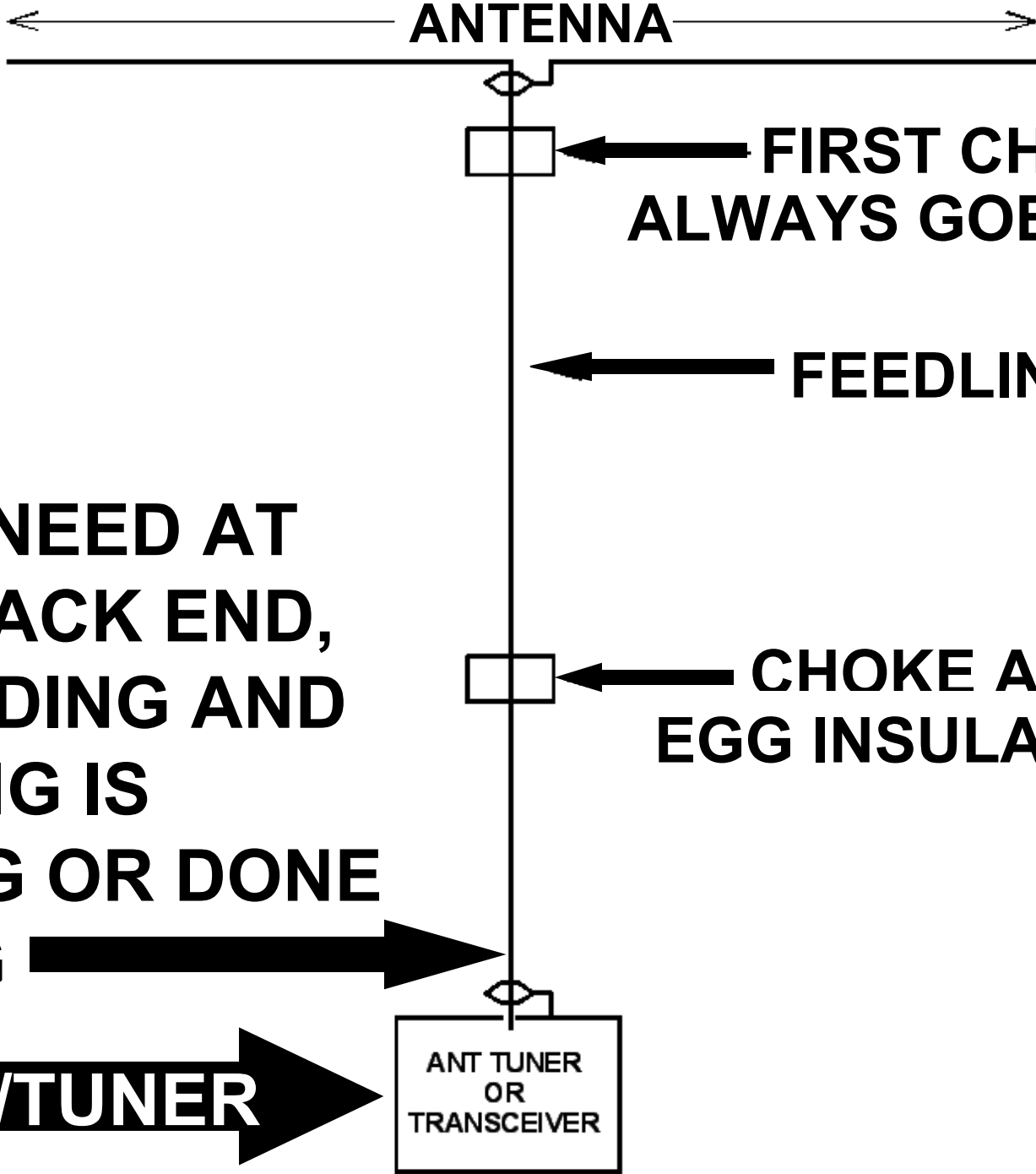

ANTENNA

**FIRST CHOKE
ALWAYS GOES HERE**

FEEDLINE

**CHOKE AS
EGG INSULATOR**

**ANT TUNER
OR
TRANSCEIVER**

RIG/TUNER

**IF YOU NEED AT
THE SHACK END,
GROUNDING AND
BONDING IS
MISSING OR DONE
WRONG**

Grounding and Bonding

- **Buy and STUDY N0AX's ARRL book, to which I contributed**
- **Download and study this slide deck (a pdf) for talks I've given here, at Visalia, and to several clubs**
<http://k9yc.com/GroundingAndAudio.pdf>
- **Don't let "Audio" in the title fool you – it's mostly about RFI and lightning safety!**
- **But it also prevents hum and buzz**

How Common Mode Chokes Work

Equivalent Circuit of a Ferrite Choke



**Simplified for Low
Frequencies**

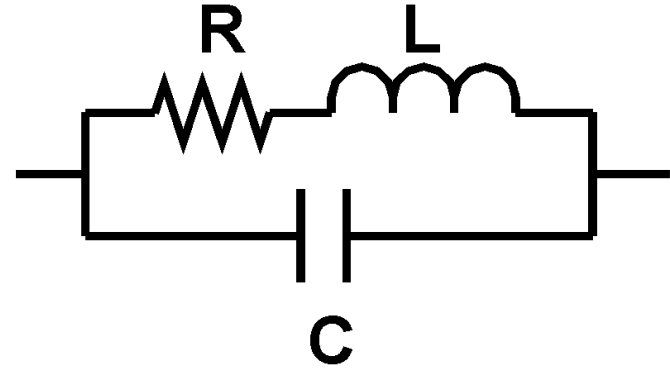

**Mid-Frequencies
(More Complete)**

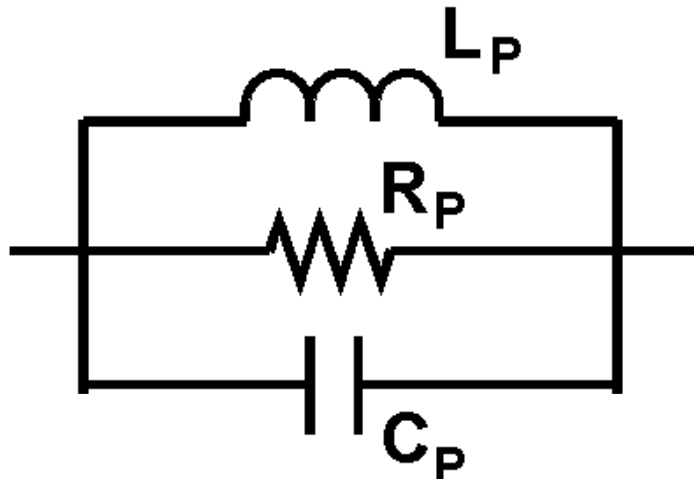

**Simplified for High
Frequencies**

More Complete Equivalent Circuit

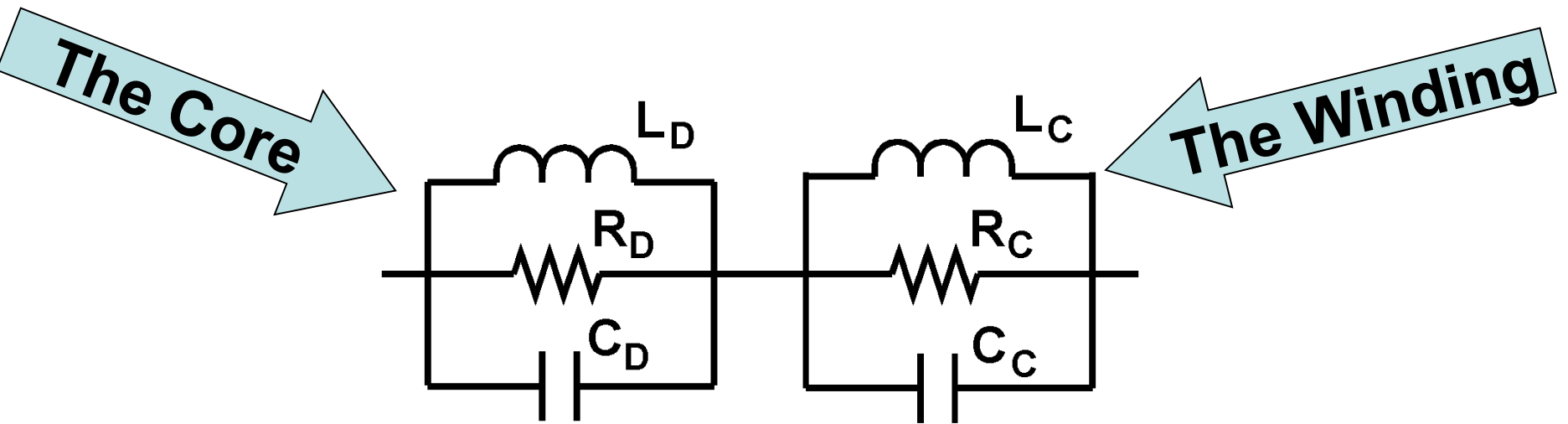

Resonances in the Core and of the Winding

(more than we have time to talk about today, but it's what makes #31 material great at MF and HF) Study k9yc.com/RFI-Ham.pdf

We'll Use This Physical Equivalent Circuit to Understand the Choke

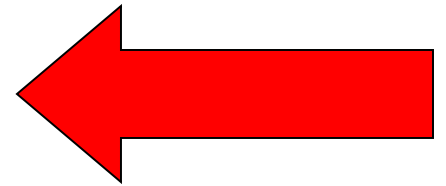
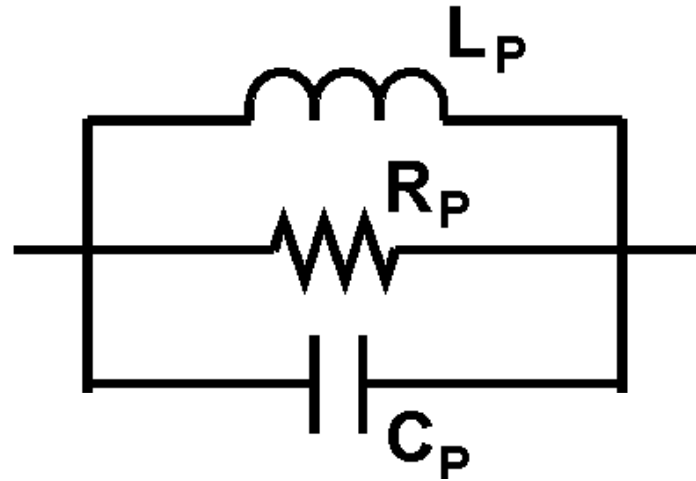

Data Sheets Use This Equivalent Circuit to Graph the Impedance



These Are The Values Our VNA Measures, Computes and Plots vs Frequency



And, R_s is what the choke adds in series with the transmission line to kill common mode current

**An Effective Choke Has A
Very High Value of R_s**

Why is Resistance So Critical?

- We want to reduce the current
- A wire shorter than $\lambda/4$ is capacitive
 - Series inductance resonates with it and increases the current
- A cable longer than $\lambda/4$ (and shorter than $3\lambda/4$) is inductive
 - Series capacitance resonates with it and increases the current
- Resistance always reduces current – if it's large enough

A High R_s Value Reduces Heating

- Power in the choke is $I^2 R_s$, where I is the common mode current
- As R_s is made larger, I falls in inverse proportion
- Since Power is $I^2 R$, it is falling twice as fast as R_s is increasing
- If R_s gets large enough, I gets very small, so power (heating) due to common current gets too small to matter

In Summary

- **Higher impedance is better!**
 - **Reduces common mode current**
 - **Reduces noise**
 - **Reduces interaction**
 - **Reduces RF in the shack**
 - **Reduces dissipation**
- **Resistance is far better than reactance**

**Now we're ready to talk about the
new cookbook.**

How Did We Get From Here

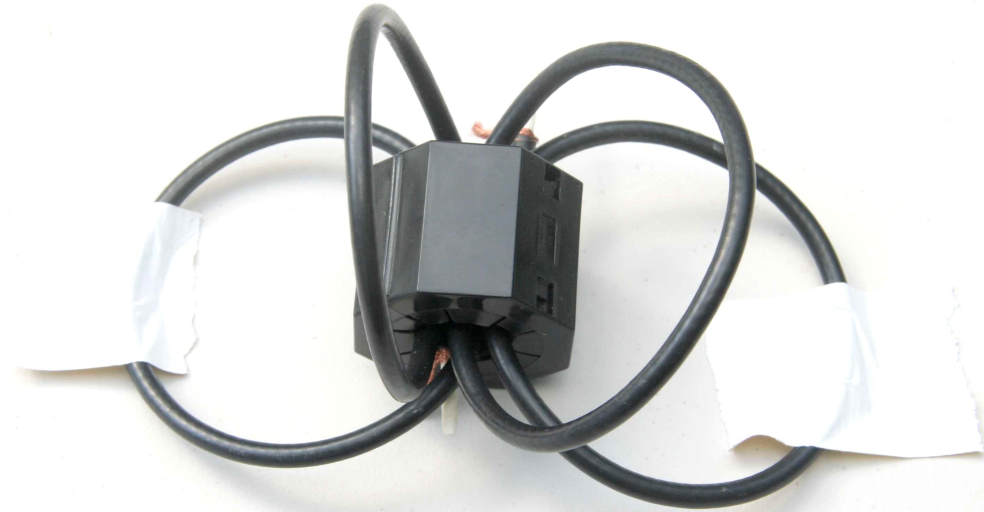

**5 turns Big
Clamp-On
RG8X**



**4 turns
RG8**



**5 turns
RG8**



**7 turns
RG8X**



To Here?

W6GJB Designs

- RG400
- Teflon #12

W6GJB's Latest Dipole Insulator Dual Chokes Prevent Interaction of Feedline With His 160M Vertical



And Here?

AB7E's Dipole Choke

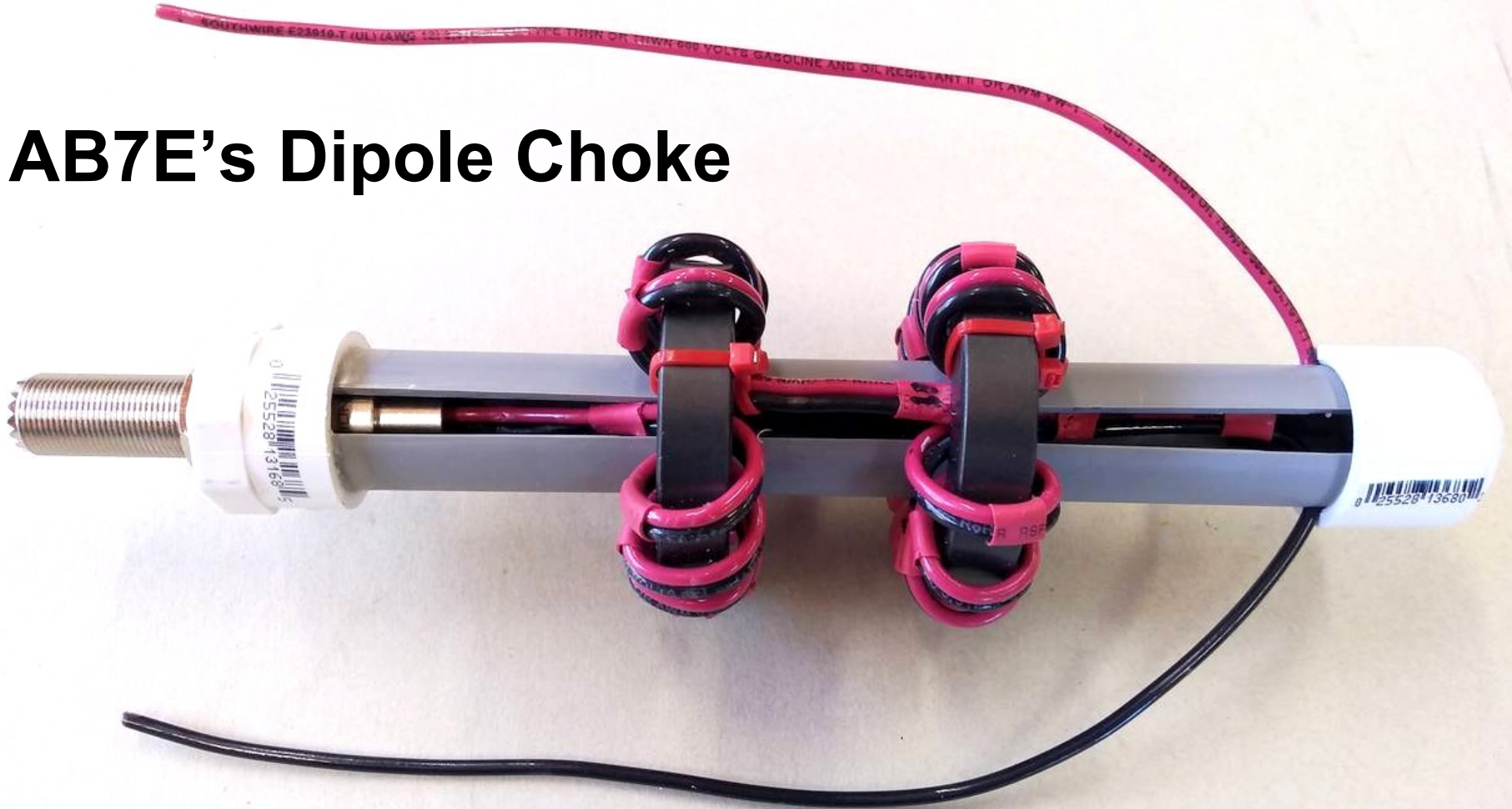

And Here? W1LJ's Inline Chokes



And Why?

2007 - 2010 Test Equipment



In 2007– 2010

- **All I could measure was Z_{MAG} , and it took half a day for about 15 data points**
- **I measured only a few chokes of a given configuration**
 - **Number of turns, number of cores**
 - **Coax type**
- **I hadn't learned that turns wound through the core(s) out of order could cancel**

2016 - 2021 Test Equipment



**Precision Vector
Network Analyzer**

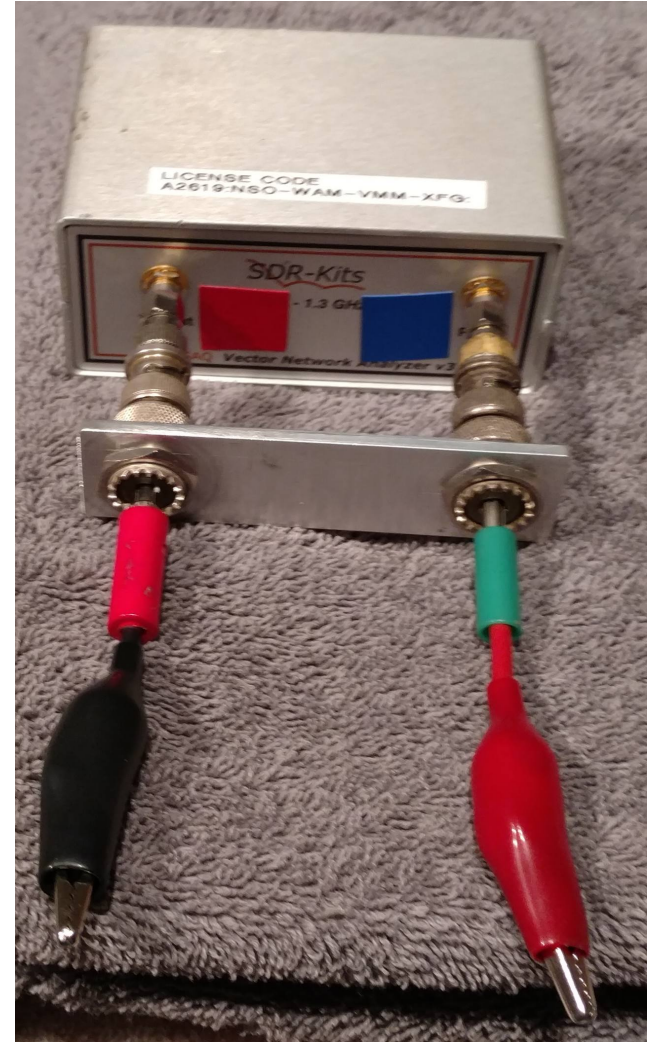

In 2016-2021

- I could measure a LOT more chokes**
- I got complex data**
- I can measure with far greater precision**
- Saw shortcomings of 2007 – 2010 designs**

2007 – 2010

- **4-5 hours / choke**
- **Scalar data**
(Z_{MAG} only)
- **Point-by-point data**
- **Enter data in**
Quattro Pro
- **Write math to**
compute Z_{MAG}
- **Generate plots**
from Quattro Pro

2016 – 2021

- **4-5 minutes / choke**
- **Complex data**
($R_S + jX_S$)
- **Swept measurement**
- **VNWA software**
computes and plots
 Z_{MAG} , R_S , X_S after
each sweep
- **Save screen grab of**
each sweep, with
markers in MF, HF
bands

In 2007– 2010

- **Component tolerance issues were obscured by poor measurement precision and use of 4-6 cores in most chokes**

Early 2-Wire (Bifilar) Chokes

- **GM3SEK observed that #31 cores were either not available in the UK, or were very expensive, so:**
- **I built some 2-wire chokes wound with #12 and #14 THHN on a single core**
- **They had very nice broad impedance curves**
- **Were much more repeatable**
 - **Consistent turn spacing**

**W6GJB's
Dipole Insulator
and Choke
Used on 80M Inv Vee**



Early 2-Wire (Bifilar) Chokes

- **W6GJB and I used a lot of them on our antennas**
- **They were effective – BUT:**
- **There were a few failures**

Fried Choke #1



Fried Choke #2



Why Did They Fail?

- **For #1, arcing to a nearby connector on center form**
- **For #2, only guessing**
 - maybe arcing when wet?
 - maybe lightning?
 - maybe very high SWR when TX on wrong band for the antenna?
- **Both were on one of my high dipoles when they failed, years apart**
 - Legal limit, CW, RTTY, SSB contesting
- **#12 THHN solid**

A New Much Larger Core

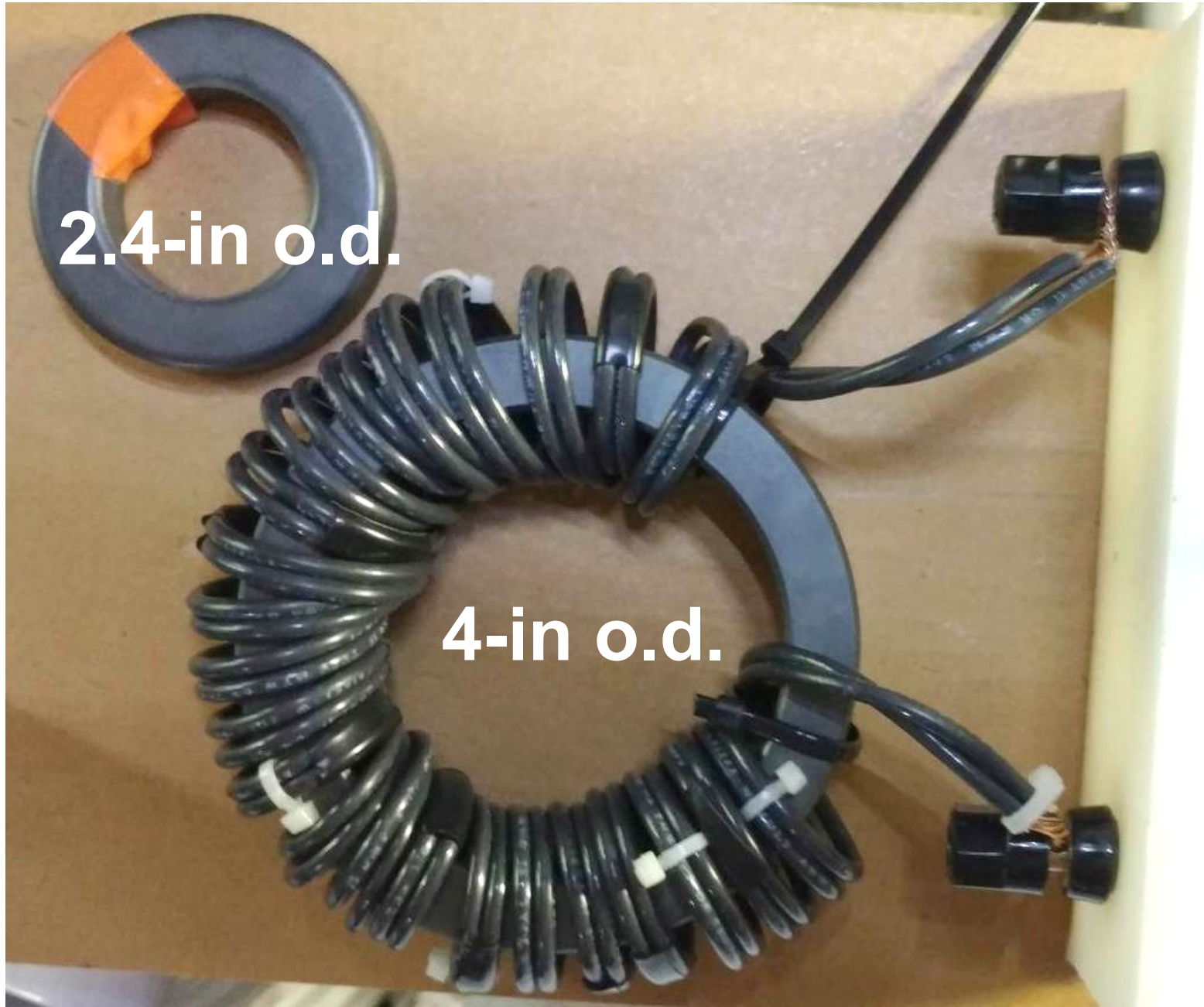

2.4-in o.d.

4-in o.d.

In 2016-2021

- **Evaluated nearly a dozen winding styles**
 - **Wire/cable types**
 - **Turn diameter and spacing**
 - **2.4-in and 4-in o.d. cores**
- **Eliminated 1-in i.d. clamp-on for TX choke applications**
 - **Difficult to wind and maintain turns without out-of-order turns**

Experimental Winding Styles

- **Paired Transmission Lines**
 - **Teflon-insulated #12**
 - **Enameled #10 and #12**
 - **THHN #10, #12 stranded and solid**
 - **White/Black from #10, #12 Romex (NM)**
- **RG213, RG400 coax**

Winding Style

- **Initial experiments used special forms built by W6GJB to maintain minimum bend radius of various coax types**
- **None of these styles produced useful chokes, and they were expensive and impractical to build**

Experimental RG213 Winding Style

New 4-in o.d. cores



Experimental RG400 Winding Style on 2.4-in o.d. Core

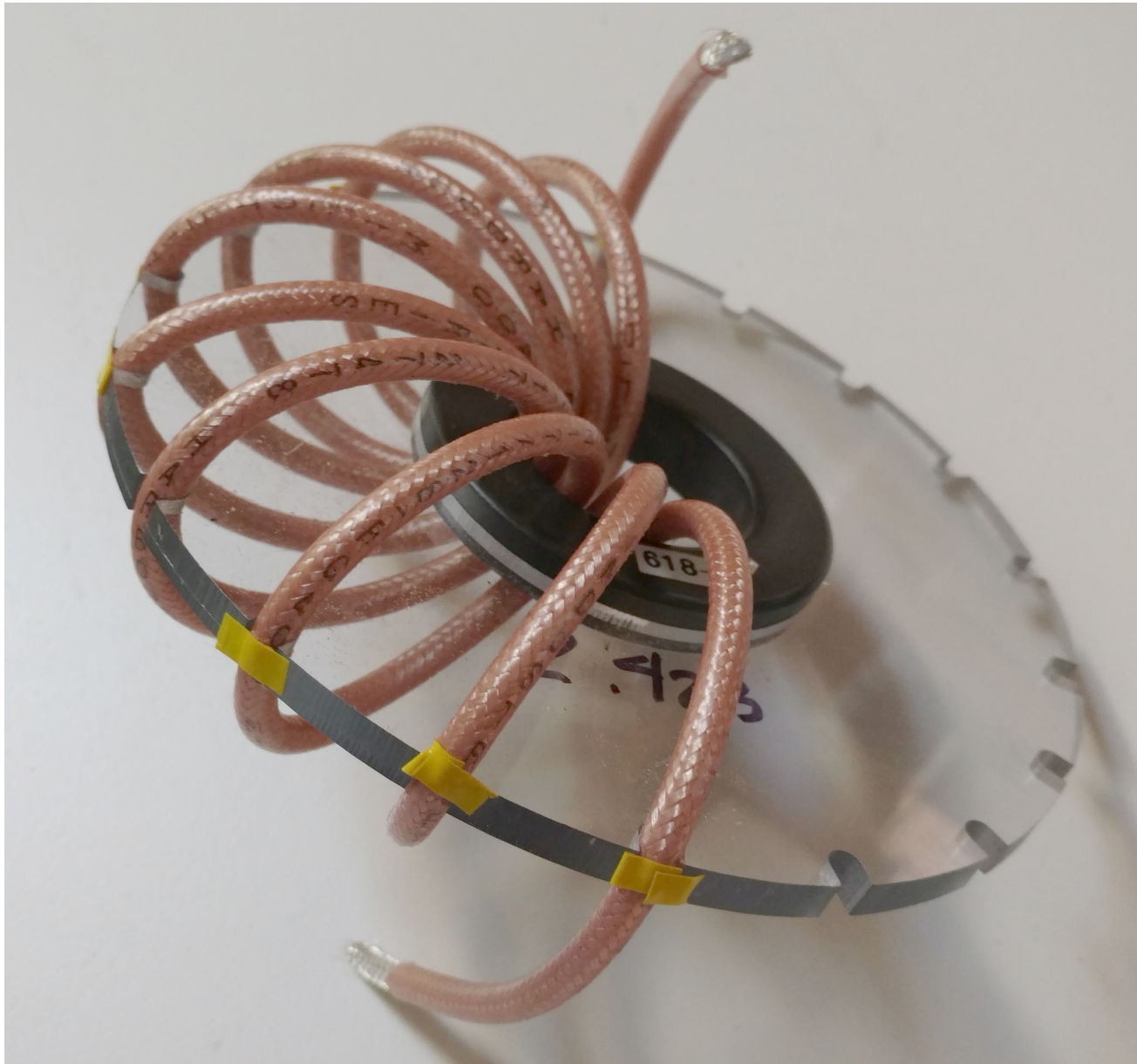

Standard Test Winding



Manufacturing Tolerances

- The greater precision allowed a study of Fair-Rite's manufacturing tolerances
- A “standard” winding was measured on almost 200 numbered cores
- Spreadsheet was created for data
- That exposed wide variations of both R_s and X_s

How Many Cores Did I Measure?

- **More than 150 2.4-o.d. cores**
 - **Purchased direct from Fair-Rite and Fair-Rite distributors over 10 years**
 - **Included one original pre-production sample from 2004**
- **About 70 4-in o.d. cores**
 - **Part of a single group purchase from a single Fair-Rite distributor**

Rejected Winding Styles

- **All those on “special” forms**
 - **Few hams could build**
 - **Chokes were fairly narrow band, so not very useful**
- **Pairs larger than #12 copper**
 - **Lower loss of #10 too small to matter**
 - **Fewer turns practical with #10**
 - **#10 more difficult to wind**
 - **More expensive**
- **All coax other than RG400**

Rejected Transmission Lines

- **Enameled copper pair, touching**
 - **Greater loss due to *proximity effect***
 - **In a transmission line with very closely spaced conductors, current is forced to a narrow section of skin adjacent to the other conductor by their magnetic fields**
 - **Same mechanism as skin effect**
 - **Increases resistive loss in the line**
 - **This loss showed up in transmission line measurements for loss**

Rejected Transmission Lines

- **THHN has nylon outer jacket that increases o.d., so fewer turns than NM (Romex) conductors can fit on a core**
- **Outer jacket degrades with UV and weather**

Chosen Transmission Lines

- **Paired Lines**
 - **Teflon-insulated #12 stranded**
 - **White/Black from #12 Romex**
- **RG400 coax**

Winding Style – Turn Spacing

- **Parasitic (stray) capacitance, mostly turn-to-turn, determines the choke's parallel resonance**
- **For repeatability, all designs use turns spaced as closely as possible and wound tightly to the core**

Why RG400?

- **RG142 has silver-coated-copper-coated solid steel center**
- **RG400 has silver-coated stranded copper center**
- **Both cables have Teflon insulation and jacket, with silver-coated copper double braid shield**
- **Loss and shielding equally good**

Why RG400?

- **For good repeatability, we must wind tight to the core, requiring a bend radius that is less than the manufacturer's spec for either cable for maximum power handling**
- **RG400's stranded center allows a tighter bend radius than RG142's solid steel with less likelihood of arcing due to center migration**

Why RG400?

- **We're still winding tighter than the manufacturer's spec, but we're also running less power, we're at HF, and it's a one-time bend (when we wind the choke)**
- **Colleagues I've consulted consider it a good compromise**
- **RG142 is widely used this way without failures, RG400 is a more conservative design**

RG400

- **Harbour Industries, based in VT and QC, part of the Berkshire-Hathaway empire, makes MIL-spec cables**
- **Their RG400 can be found on eBay**
- **Very well shielded**
- **Loss of all RG400 is comparable to RG58**

Why Teflon #12 Pairs?

- **Better performance than NM (Romex)**
- **Much higher temperature rating**
- **Much higher voltage breakdown**
- **Stranded #12 silver-coated copper has low loss and winds as well as #12 NM solid**
- **Z_0 near 100 ohms, better match to some antennas (e.g., high dipoles)**

Buying Teflon Wire

- **Spool ends and surplus can be found on eBay**
- **I paid about \$0.80/ft in 2017-8**
 - **\$1.60/ft for a Teflon pair**
- **NM-12 costs about \$0.45/ft (25 ft)**
 - **\$0.90/ft for an NM pair**

Transmission Line Properties

- **V_F , Z_0 and loss vary with frequency**
- **It comes from the fundamental transmission line equations**
- **True for ALL transmission lines**
- **Here's measured data for RG400**

Z₀ and Loss, Linear Vertical Scales

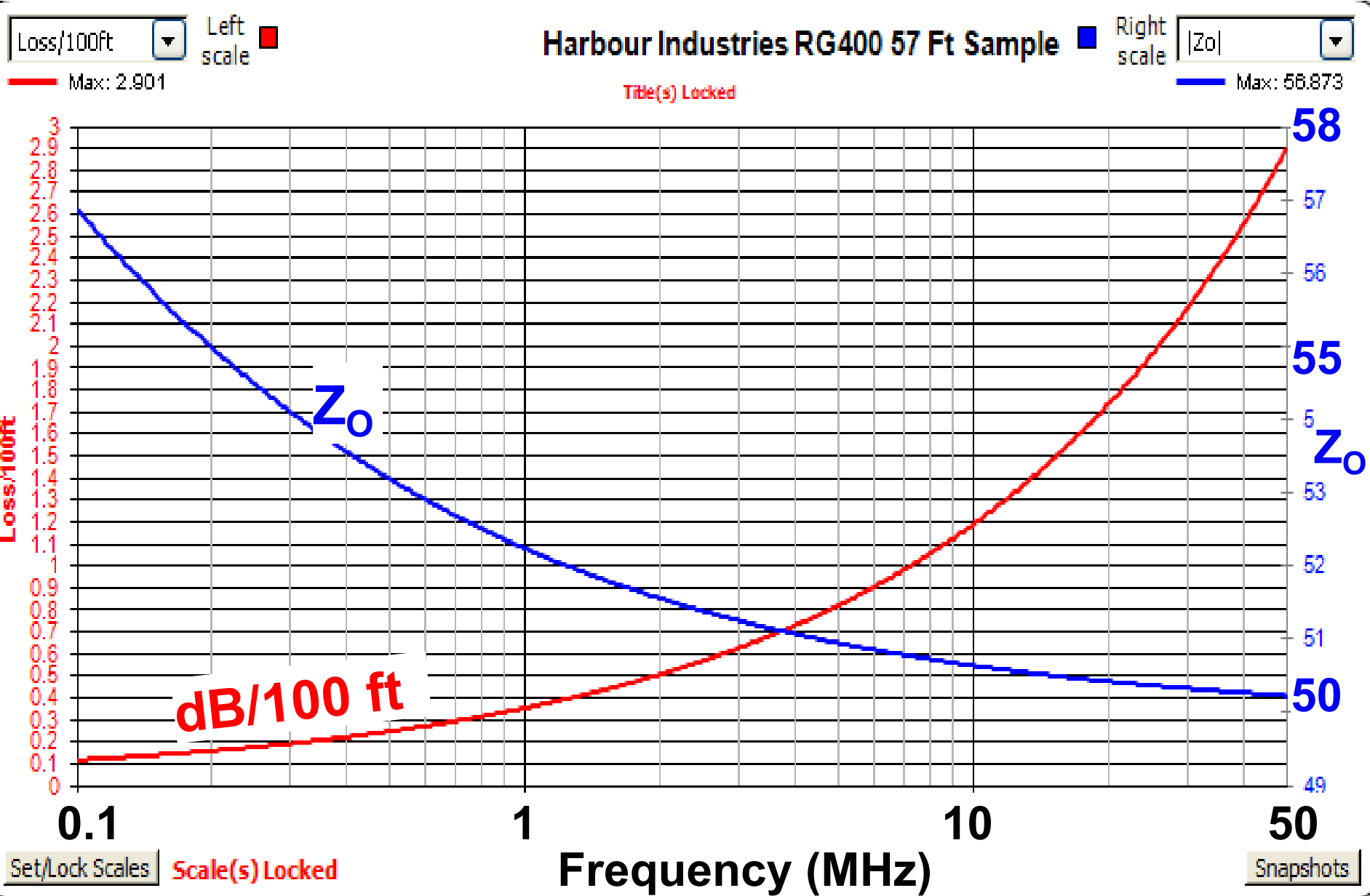

Loss, Log Vertical Scale, VF Linear

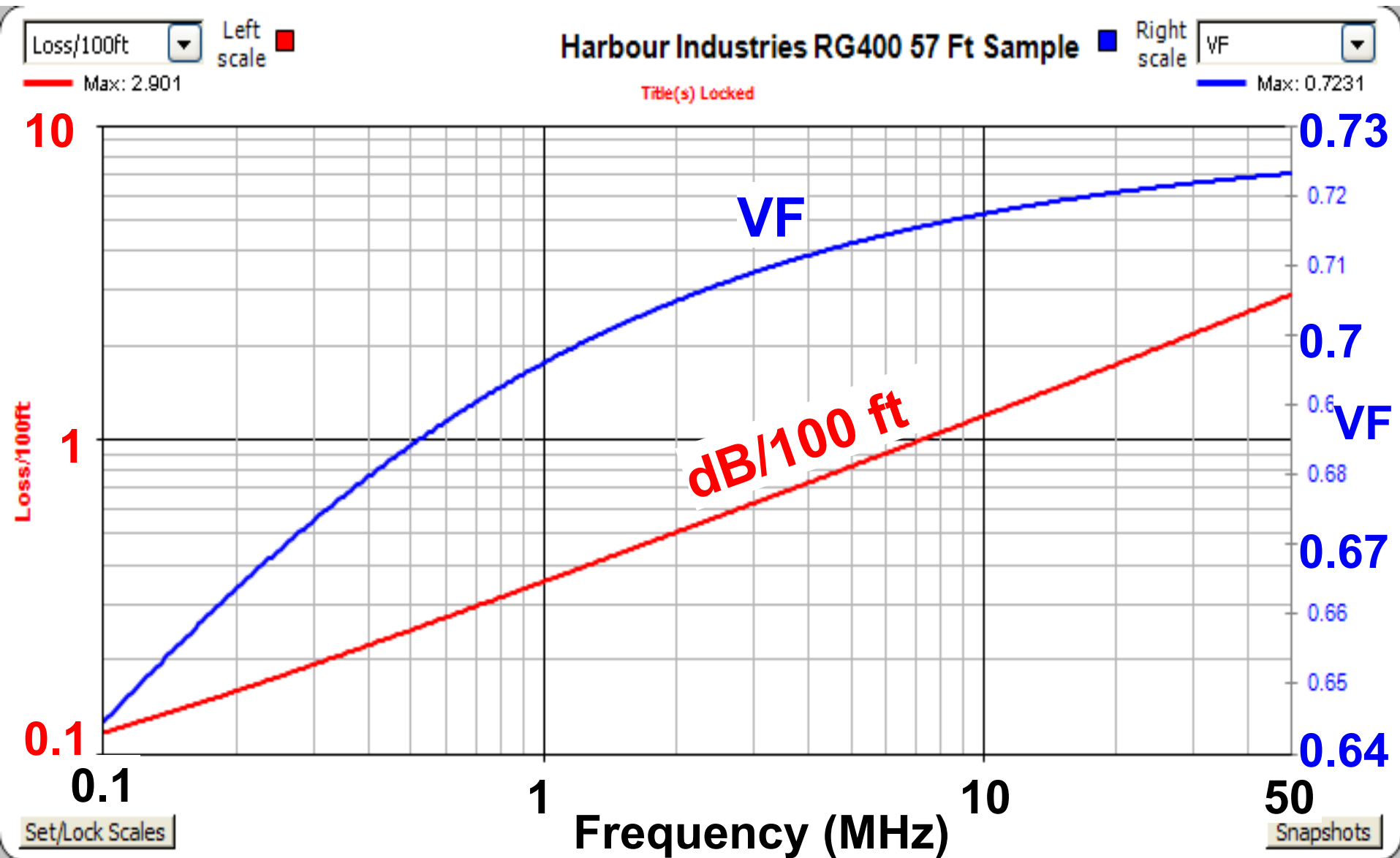

The Chosen Transmission Lines

	Z_0 @ 5 MHz	VF @ 5 MHz	10 MHz dB/100 ft
#12 NM	87 Ω	.73	1.6
#12 Teflon	101 Ω	.83	.94
RG400	51 Ω	.69	1.2

Measuring For The Cookbook

- **We're measuring a parallel resonant circuit**
- **For each measurement, the choke must have “zero length” leads**

Manufacturing Tolerances

- **For both core sizes, I selected cores with R_S and X_S values at their limits**
- **Wound turns of each line type to fill each of four “limits” cores**
- **Measurement taken, screen grab saved for R_S and X_S**
- **Cut one turn, strip leads, repeat until choke is no longer useful at HF**

Manufacturing Tolerances

- In another spreadsheet, R_s values were tabulated for each winding on each of the four limits cores for each ham band
- For each choke recommendation (per band), “worst case” (lowest) R_s values from the four “limits” cores were used to build published tables

How Much R_S Do I Need?

- **For well matched and reasonably well balanced antennas**
 - **5K Ω for noise rejection, and TX up to 500W**
 - **10-15K Ω for TX up to 1,500W**

How Much R_S Do I Need?

- **These chokes are designed for use at the feedpoint and in the feedlines of well-matched and reasonably well balanced antennas**
- **In unmatched, poorly matched, and/or poorly balanced antennas**
 - **They may fail**
 - **They may be ineffective**
 - **2-10 times larger R_S values may be required**

Non-Resonant All-Band Antennas

- These chokes are not designed for use in off-center or center fed antennas using open wire or window line as a feedline**
- If one or more chokes IS used with these antennas, it should be wound with #12 Teflon, it MUST be at the feedpoint, and it should have a very high R_S value at all frequencies of interest**
- And even then it could fail destructively**

The Per-Band Tables

Single 2.4-in o.d. Core Chokes

RG400

Teflon #12

NM/THHN #12

160M:

18 turns
(10K Ω)

17 turns
(6K Ω)

18 turns (9.5K Ω)
17 turns (7K Ω)

18 turns (9.5K Ω)
17 turns (9K Ω)
16 turns (6K Ω)

Single 2.4-in o.d. Core Chokes

RG400

Teflon #12

NM/THHN #12

40M:

14 turns (6.2K Ω)

15 turns (5.4K Ω)

13 turns (5K Ω)

15 turns (6.5K Ω)

14 turns (5.8K Ω)

13 turns (5K Ω)

14 turns (6K Ω)

13 turns (5K Ω)

30M:

14 turns (6.5K Ω)

13 turns (5.5K Ω)

12 turns (5K Ω)

14 turns (6K Ω)

15 turns (5.5K Ω)

13 turns (5K Ω)

13-14 turns

(5.5K Ω)

Multiple Single 2.4-in o.d. Core Chokes in Series to Cover Multiple Bands

RG400

Teflon #12

NM/THHN #12

160-40M:

**Two 15 turn
chokes**

**(6K Ω 160M,
14K Ω 80M,
11K 40M)**

**Two 15 turn
chokes**

**(6.5K Ω 160M,
14K Ω 80M,
7K 40M)**

**Two 15 turn
chokes**

**(6.5K Ω 160M,
14K Ω 80M,
7K 40M)**

Multiple Single 2.4-in o.d. Core Chokes in Series to Cover Multiple Bands

**160-
80M:**
Two 17 turn
chokes (12K Ω)

Teflon #12
Two 17 turn
chokes
(14K Ω 160M,
12K Ω 160M)
Two 16 turn
chokes
(8K Ω 160M,
13K Ω 80M,
7K 40M)

NM/THHN #12
Two 16 turn chokes
(11-12K Ω)

4-in o.d. Core Chokes

RG400

Teflon #12

NM/THHN #12

80M:

18-20 turns

(11K Ω)

21 turns (10K Ω)

17 turns (9.5K Ω)

22 turns (9K Ω)

16 turns (8.5K Ω)

23 turns (7.5K Ω)

15 turns (7.5K Ω)

14 turns (6.5K Ω)

13 turns (5.5K Ω)

16-18 turns

(7.5K Ω)

15 turns (7.2K Ω)

19 turns (7K Ω)

14 turns (6.5K Ω)

20-21 turns (6K Ω)

17 turns (5.5K Ω)

13 turns (5.5K Ω)

15-16 turns

(6.7K Ω)

17 turns (6.5K Ω)

14 turns (6.4K Ω)

18 turns (6.2K Ω)

19 turns (5.5K Ω)

13 turns (5.5K Ω)

20 turns (5K Ω)

The Tables

Teflon #12 Silver Stranded Copper Pair on a Single 2.4-in o.d. #31 Toroid																Diff'l Mode Dissipation (W)								Approx		Len			
Turns	Choking Impedance Rs (Ohms) at F (MHz)										Attenuation at F MHz (dB)								at F MHz at 1.5kW								Cost	Wt Lb	(Ft)
	1.8	2	3.5	4	7	7.3	10	14	21	28	1.8	3.5	7	10	14	21	28	1.8	3.5	7	10	14	21	28					
19	10,073	7,875	1,822	1,206	150	116					0.02	0.02	0.04	0.05	0.06	0.08	0.10	6	8	13	16	21	28	36	\$23	11	4.9		
18	9,603	10,403	3,732	2,369	391	316					0.02	0.02	0.03	0.04	0.06	0.08	0.10	6	8	12	15	19	27	34	\$22	11	4.6		
17	7,303	9,223	6,763	5,346	1,166	994	244				0.01	0.02	0.03	0.04	0.05	0.07	0.09	5	7	11	14	18	25	32	\$22	10	4.3		
16	4,068	5,116	7,224	6,586	3,511	3,304	1,789	674			0.01	0.02	0.03	0.04	0.05	0.07	0.08	5	7	10	13	17	23	29	\$21	10	4.0		
15	3,260	4,053	6,741	6,666	6,468	6,463	5,468	3,205	939		0.01	0.02	0.03	0.04	0.05	0.06	0.08	5	6	10	12	16	22	28	\$21	10	3.8		
14	2,439	3,012	5,801	5,896	5,707	5,855	6,149	4,959	2,483	339	0.01	0.02	0.03	0.03	0.04	0.06	0.07	4	6	9	12	15	20	26	\$21	10	3.5		
13	2,025	2,479	4,796	4,977	4,940	4,970	5,310	5,553	3,884	2,379	0.01	0.02	0.02	0.03	0.04	0.05	0.07	4	5	8	11	14	19	24	\$20	10	3.3		
12	1,657	2,010	3,958	4,193	4,571	4,591	4,584	5,067	4,797	3,284	0.01	0.01	0.02	0.03	0.04	0.05	0.06	4	5	8	10	13	18	23	\$20	10	3.1		
11	1,376	1,656	3,181	3,428	3,932	3,963	3,853	4,271	4,708	3,897	0.01	0.01	0.02	0.03	0.03	0.05	0.06	3	5	7	9	12	16	21	\$20	10	2.9		
10	1,107	1,323	2,536	2,746	3,309	3,344	3,672	3,644	4,154	4,327	0.01	0.01	0.02	0.02	0.03	0.04	0.06	3	4	7	9	11	15	19	\$19	9	2.6		
9	880	1,048	1,986	2,159	2,680	2,713	3,028	2,999	3,431	3,831	0.01	0.01	0.02	0.02	0.03	0.04	0.05	3	4	6	8	10	14	17	\$19	9	2.4		
8	686	818	1,516	1,679	2,113	2,141	2,417	2,720	2,866	3,221	0.01	0.01	0.02	0.02	0.03	0.04	0.05	3	4	5	7	9	12	16	\$18	9	2.2		
7	519	613	1,129	1,249	1,606	1,632	1,857	2,158	2,281	1,927	0.01	0.01	0.01	0.02	0.02	0.03	0.04	2	3	5	6	8	11	14	\$18	9	1.9		

What The Colors and Bold Mean

Not Bold	Useful on this band
Bold Value	Better on this band
Bold Red	Great on this band
Grayed	Poor choice for this band

The Tables

Teflon #12 Silver Stranded Copper Pair on a Single 2.4-in o.d. #31 Toroid																Diff'l Mode Dissipation (W)								Approx		Len			
Turns	Choking Impedance Rs (Ohms) at F (MHz)										Attenuation at F MHz (dB)								at F MHz at 1.5kW								Cost	Wt Lb	(Ft)
	1.8	2	3.5	4	7	7.3	10	14	21	28	1.8	3.5	7	10	14	21	28	1.8	3.5	7	10	14	21	28					
19	10,073	7,875	1,822	1,206	150	116					0.02	0.02	0.04	0.05	0.06	0.08	0.10	6	8	13	16	21	28	36	\$23	11	4.9		
18	9,603	10,403	3,732	2,369	391	316					0.02	0.02	0.03	0.04	0.06	0.08	0.10	6	8	12	15	19	27	34	\$22	11	4.6		
17	7,303	9,223	6,763	5,346	1,166	994	244				0.01	0.02	0.03	0.04	0.05	0.07	0.09	5	7	11	14	18	25	32	\$22	10	4.3		
16	4,068	5,116	7,224	6,586	3,511	3,304	1,789	674			0.01	0.02	0.03	0.04	0.05	0.07	0.08	5	7	10	13	17	23	29	\$21	10	4.0		
15	3,260	4,053	6,741	6,666	6,468	6,463	5,468	3,205	939		0.01	0.02	0.03	0.04	0.05	0.06	0.08	5	6	10	12	16	22	28	\$21	10	3.8		
14	2,439	3,012	5,801	5,896	5,707	5,855	6,149	4,959	2,483	339	0.01	0.02	0.03	0.03	0.04	0.06	0.07	4	6	9	12	15	20	26	\$21	10	3.5		
13	2,025	2,479	4,796	4,977	4,940	4,970	5,310	5,553	3,884	2,379	0.01	0.02	0.02	0.03	0.04	0.05	0.07	4	5	8	11	14	19	24	\$20	10	3.3		
12	1,657	2,010	3,958	4,193	4,571	4,591	4,584	5,067	4,797	3,284	0.01	0.01	0.02	0.03	0.04	0.05	0.06	4	5	8	10	13	18	23	\$20	10	3.1		
11	1,376	1,656	3,181	3,428	3,932	3,963	3,853	4,271	4,708	3,897	0.01	0.01	0.02	0.03	0.03	0.05	0.06	3	5	7	9	12	16	21	\$20	10	2.9		
10	1,107	1,323	2,536	2,746	3,309	3,344	3,672	3,644	4,154	4,327	0.01	0.01	0.02	0.02	0.03	0.04	0.06	3	4	7	9	11	15	19	\$19	9	2.6		
9	880	1,048	1,986	2,159	2,680	2,713	3,028	2,999	3,431	3,831	0.01	0.01	0.02	0.02	0.03	0.04	0.05	3	4	6	8	10	14	17	\$19	9	2.4		
8	686	818	1,516	1,679	2,113	2,141	2,417	2,720	2,866	3,221	0.01	0.01	0.02	0.02	0.03	0.04	0.05	3	4	5	7	9	12	16	\$18	9	2.2		
7	519	613	1,129	1,249	1,606	1,632	1,857	2,158	2,281	1,927	0.01	0.01	0.01	0.02	0.02	0.03	0.04	2	3	5	6	8	11	14	\$18	9	1.9		

It's an eye chart, so let's zoom in.

Minimum Choking Impedances

Teflon #12 Silver Stranded Copper Pair on a Single 2.4-in o.d. #3										
	Choking Impedance Rs (Ohms) at F (MHz)									
Turns	1.8	2	3.5	4	7	7.3	10	14	21	28
19	10,073	7,875	1,822	1,206	150	116				
18	9,603	10,403	3,732	2,369	391	316				
17	7,303	9,223	6,763	5,346	1,166	994	244			
16	4,068	5,116	7,224	6,586	3,511	3,304	1,789	674		
15	3,260	4,053	6,741	6,666	6,468	6,463	5,468	3,205	939	
14	2,439	3,012	5,801	5,896	5,707	5,855	6,149	4,959	2,483	339
13	2,025	2,479	4,796	4,977	4,940	4,970	5,310	5,553	3,884	2,379
12	1,657	2,010	3,958	4,193	4,571	4,591	4,584	5,067	4,797	3,284
11	1,376	1,656	3,181	3,428	3,932	3,963	3,853	4,271	4,708	3,897
10	1,107	1,323	2,536	2,746	3,309	3,344	3,672	3,644	4,154	4,327
9	880	1,048	1,986	2,159	2,680	2,713	3,028	2,999	3,431	3,831
8	686	818	1,516	1,679	2,113	2,141	2,417	2,720	2,866	3,221
7	519	613	1,129	1,249	1,606	1,632	1,857	2,158	2,281	1,927

Differential Loss and Heat in Coax

1 Toroid							Diff'l Mode Dissipation (W)						
Attenuation at F MHz (dB)							at F MHz at 1.5kW						
1.8	3.5	7	10	14	21	28	1.8	3.5	7	10	14	21	28
0.02	0.02	0.04	0.05	0.06	0.08	0.10	6	8	13	16	21	28	36
0.02	0.02	0.03	0.04	0.06	0.08	0.10	6	8	12	15	19	27	34
0.01	0.02	0.03	0.04	0.05	0.07	0.09	5	7	11	14	18	25	32
0.01	0.02	0.03	0.04	0.05	0.07	0.08	5	7	10	13	17	23	29
0.01	0.02	0.03	0.04	0.05	0.06	0.08	5	6	10	12	16	22	28
0.01	0.02	0.03	0.03	0.04	0.06	0.07	4	6	9	12	15	20	26
0.01	0.02	0.02	0.03	0.04	0.05	0.07	4	5	8	11	14	19	24
0.01	0.01	0.02	0.03	0.04	0.05	0.06	4	5	8	10	13	18	23
0.01	0.01	0.02	0.03	0.03	0.05	0.06	3	5	7	9	12	16	21
0.01	0.01	0.02	0.02	0.03	0.04	0.06	3	4	7	9	11	15	19
0.01	0.01	0.02	0.02	0.03	0.04	0.05	3	4	6	8	10	14	17
0.01	0.01	0.02	0.02	0.03	0.04	0.05	3	4	5	7	9	12	16
0.01	0.01	0.01	0.02	0.02	0.03	0.04	2	3	5	6	8	11	14

Differential Loss and Heat

- **The loss inside the coax as a function of its length and inherent loss parameters**
- **Dissipation (heat) computed from loss for key-down U.S. legal limit (1.5kW)**
- **Actual dissipation depends on duty cycle**
 - **25% – 33% for CW and SSB**
 - **35% – 40% for WSJT modes**
 - **can exceed 50% for RTTY contesting**
 - **Long transmissions → 100% duty cycle**

Total Dissipation In A Choke

- Is the sum of differential mode and common mode heating**
- Find differential mode from the tables**
- Common mode power a function of the common mode circuit, including the antenna**
- Compute common mode from NEC or other modeling software**

In NEC

- **Add a wire to the model having the diameter of the feedline with it's physical length approximating the geometry of its geometry to what it's connected to**
- **Add a resistance R_S to that wire at the point where the choke is inserted**
- **On the Options Tab, set Power to 1500W**
- **Compute the pattern, use the Currents Tab to find current in the choke**
- **Common mode power is I^2R_S**
- **Correct for duty cycle**

Approx			Len
Cost	Wt Lb		(Ft)
\$23	11		4.9
\$22	11		4.6
\$22	10		4.3
\$21	10		4.0
\$21	10		3.8
\$21	10		3.5
\$20	10		3.3
\$20	10		3.1
\$20	10		2.9
\$19	9		2.6
\$19	9		2.4
\$18	9		2.2
\$18	9		1.9

Cost, Weight, Length

- **Cost and weight include the core, coax or wire, two Amphenol 83-1SP silver-teflon connectors with reducers, and a simple structure to hold choke**
- **Length includes ~ 8-in for leads, and was used to compute loss**

The Big 4-in o.d. Cores

- **I spent a lot of time and money to figure out that they're only useful on 160 and 80, and I'm only using them at the feedpoint of 160M verticals**
 - **Heavy, so poor choice for dipole feedpoints**
 - **More expensive than two 2.4-in cores that work as well or better**

Chokes Need Air Flow

- NA6O did some excellent lab work to quantify this as part of building matching networks for use at the N6RO superstation**
- He confirmed my advice that without air flow, enclosed chokes will fail**

NA60's Enclosure



Avoid Conductive Enclosures

- **Connectors bonded to the enclosure short out the choke**
- **Proximity to the enclosure can detune the choke**

Winding Guidelines

Pairing Wires For 2-Wire Lines

- **Use two different colors for a pair**
- **Tie the two conductors together using Scotch 33 or 35 every 4-6 inches**
 - **Thinner than 88, so slightly closer turn spacing**
 - **May squeeze another turn on 2.4-in core for 160M chokes**

Starting the Wind

- **Wind small cable tie around the core where you want to start the winding and pull not quite tight**
- **Feed winding through the core from below, use second tie to secure the winding to the first tie, leaving enough of the cable to connect choke when finished**
- **Snip ends of ties with $\frac{1}{4}$ -in remaining so it can be made tighter later**

Winding Coax

- **Wind turns in sequence – out of sequence turns can cancel**
- **Proceed around the core, with each turn very tight to the previous one**
- **Turns can be continued on a second layer when the core is filled, overlaying them over the start of the winding**

Paired Lines

- **Make certain the pair is not reversed as it it wound – this also causes cancelled turns**
- **Use different colors for the two conductors so that reversed pairs stand out visually**
- **Use solid NM, stays in place better than stranded**
- **Stranded Teflon does stay place very well**

Maintain Polarity

- **Make sure that the same conductor is connected to the shield at both ends**
- **This is critical for chokes used in arrays**
 - **The choke will work, but the array won't, or won't have the intended directivity**
- **Also critical for lightning protection**

Maintain Polarity Through The Choke

- **Polarity is the positive or negative sense of a signal**
 - **What we have (wrongly) called “phase”**
 - **Polarity is either normal or reversed**
 - **We change polarity by reversing the conductors, or passing through an inverting gail stage**
 - **Polarity is the same at all frequencies**

Phase Is Different From Polarity

- Phase has meaning only at a single frequency**
- Phase is related to frequency and time**
- Phase shift in a transmission line increases both with frequency and its physical length**
- Impedance is the ratio of voltage to current, including the phase difference, and it varies along both an antenna and a transmission line**

Phase Is Different From Polarity

- **The difference is critical when designing matching networks and phasing sections**

Using With Manufactured Antennas

- **Always use the manufacturer's matching system, connecting it directly to the antenna**
- **Add one of these chokes between the feedline and that matching system:**
 - **to improve noise immunity and prevent noise and signals picked up on the transmission line from filling nulls in the antennas pattern**
 - **to minimize coupling to other antennas in multi-transmitter operation**

Using In Arrays

- Like any other antenna, the choke should be a the feedpoint of each element of an array
- Care must be taken that the choke does not change the phasing of the array

Use In Arrays

- **For arrays with 75 ohm phasing lines, substitute RG302 for RG400 using the cookbook guidelines, shortening the phasing lines to make up for the added choke**
- **The Cookbook includes guidelines for using miniature RG179 in four-square arrays where legal limit power is divided between the four elements**

Rigging Chokes To Beam Antennas

- Capacitive coupling around a choke will detune it, making it ineffective**
- Rig chokes so that the coax on either side does not couple capacitively to the boom**
- For example, suspend the choke an inch or two below the boom, lashing coax to the boom at a single point on each side of the choke, minimizing the length of coax in contact with the boom**

Two Cores Or One?

- **Compared to a single core choke, the same number of turns wound on two cores will approximately**
 - **double the winding inductance**
 - **double the winding capacitance**
 - **divide the resonant frequency by two**
 - **double the impedence at resonance**
 - **double the power handling**

Identical Single Core Chokes In Series

- **Compared to a single choke, two identical chokes in series has**
 - **the same resonant frequency**
 - **double the impedance at every frequency**

Compared To a Single Choke, Two Identical Chokes In Series:

- Have the same resonant frequency**
- Have twice the impedance at every frequency**
- Can handle 4 times the power**
 - Total power (heat) is half that for a single choke, because total R_s has doubled**
 - Each choke sees half of that power**

13 Turns on One Core

DG85AQ Vector Network Analyzer Software

5/16/2018 4:14:48 PM #12 NM 13 Turns One 2.4-in o.d. core

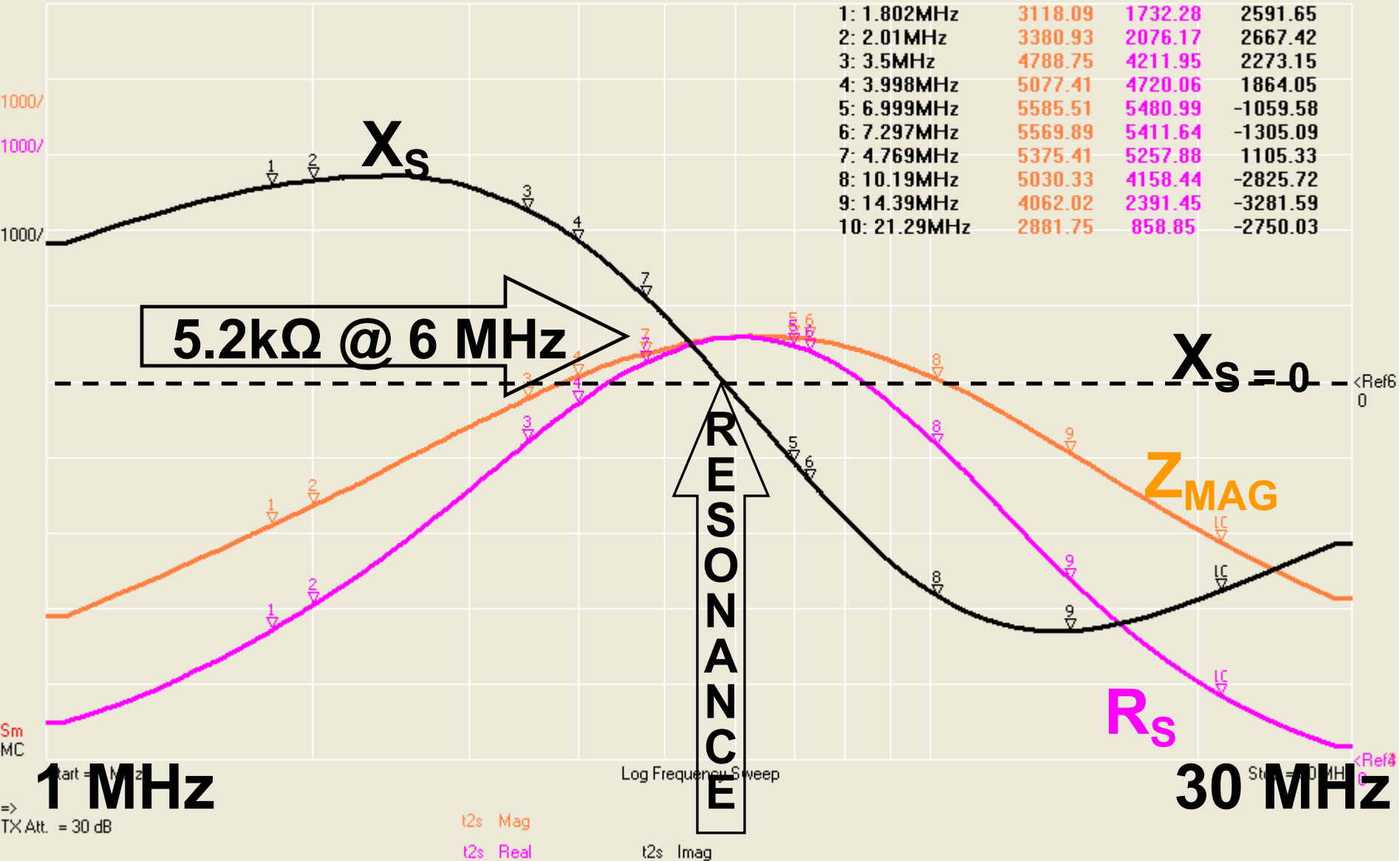

13 Turns on Two Cores

DG85AQ Vector Network Analyzer Software

5/15/2018 12:46:37 PM #12 NM 13 Turns Two 2.4-in o.d.cores

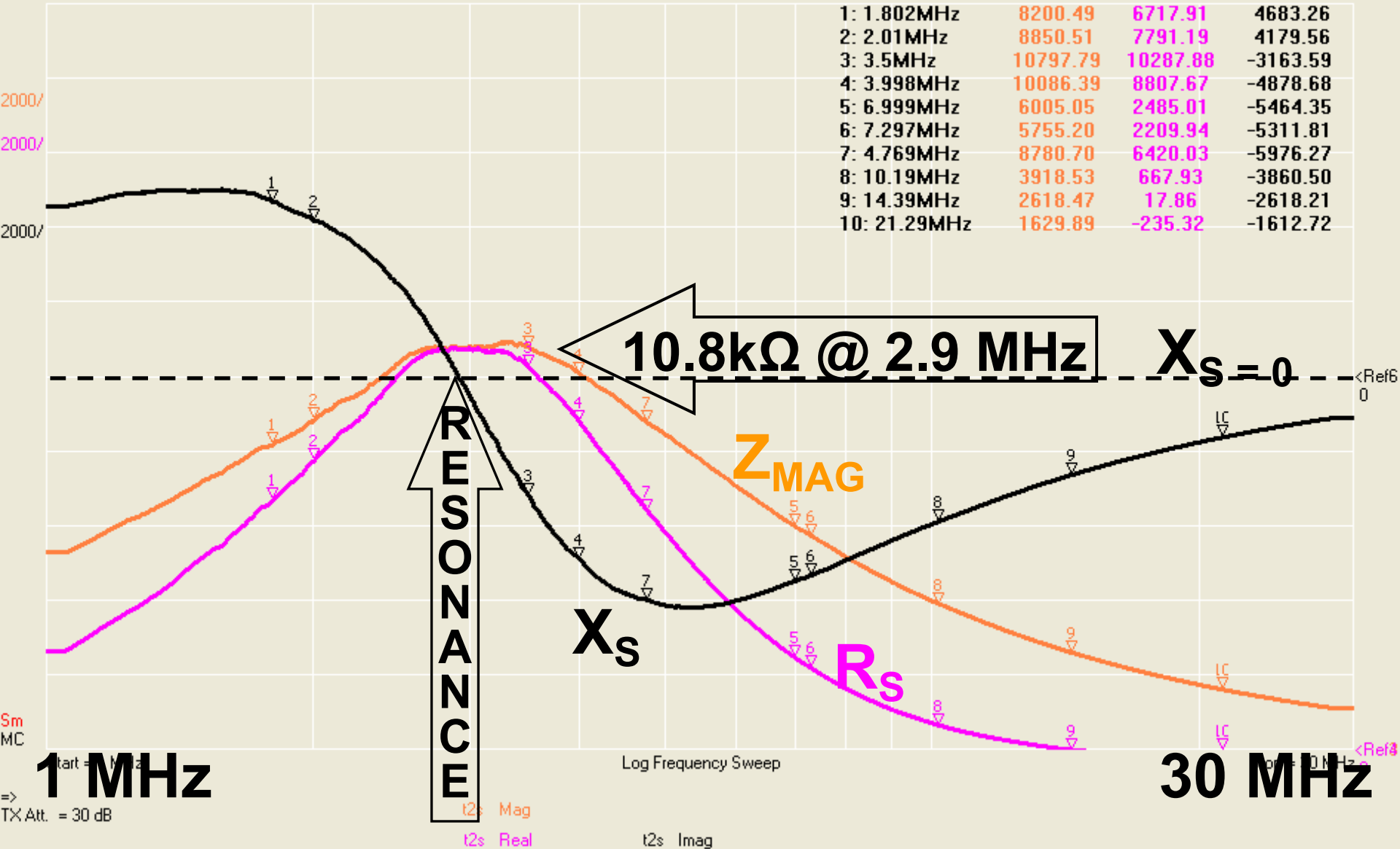

References

- **ARRL Handbook**
- **ARRL Antenna Book**
- **k9yc.com/2018Cookbook.pdf**
- **k9yc.com/RFI-Ham.pdf**



**Please
Copy**

The 2018 Cookbook For HF Transmitting Chokes

Jim Brown K9YC

k9yc@arri.net

<http://k9yc.com/publish.htm>